

Wireless Network of Electronic Scales To Monitor the Substrate Volumetric Water Content for Managing Irrigation of Containerized Seedlings Produced in Forest Nurseries

Daniel Girard and Jean Gagnon

Forest Nursery Specialist Technician, Ministère des Forêts, de la Faune et des Parcs (MFFP), Direction de la recherche forestière (DRF), Québec City, Québec, Canada; Forest Nursery Researcher, MFFP, DRF, Québec City, Québec, Canada

Abstract

An automated monitoring system of substrate volumetric water content (VWC) based on gravimetry has been developed to measure several seedling containers at a time. This tool is a wireless sensor network (WSN) using field stand-alone electronic scales that transmit data to the nursery office. At the office, computer software automatically estimates the fresh mass of any seedling crop, at any moment of the season, and then calculates the substrate VWC. This system, specifically designed for forest nurseries, is, to our knowledge, the first in which gravimetry is automatically monitored by using field stand-alone WSN technology to improve irrigation management and reduce water and nutrient losses and groundwater contamination.

Introduction

Of the 133 million containerized and bareroot forest seedlings produced in the 19 forest nurseries in Québec (Canada) in 2015, the majority (94 percent) were containerized (Arseneault 2015). In these nurseries, the growing season duration ranges between 150 and 200 days (end of April to the beginning of November). Containerized seedlings are usually produced in 2 years, and the final seedling dry mass ranges from 1.5 to 13 g (0.05 to 0.43 oz). These seedlings are grown in low-density, peat moss-based substrates (0.08 to 0.12 g/cm³ [0.0018 to 0.0026 oz/in³]) in cavities having volumes ranging from 50 cm³ (3.05 in³) up to 350 cm³ (21.36 in³).

For every nursery that grows containerized seedlings in such low-density substrates, water represents

most of the measured mass. Thus, weighing containers (gravimetry) is an excellent way to measure volumetric water content (VWC) of the substrate. The monitoring of substrate VWC is essential to successfully managing the irrigation of containerized seedlings produced in forest nurseries and will lead to a more rational use of water, fertilizers, and pesticides and to improved protection of groundwater.

Two main technologies are used for substrate VWC measurements: (1) gravimetry (Prehn et al. 2010) and (2) reflectometry, which is based on the dielectric properties of the substrate. Two examples of the latter technology are time-domain reflectometry (TDR) (Topp and Davis 1985) and capacitance-based sensors (Burnett and van Iersel 2008). A third technology in addition to those of gravimetry and reflectometry is tensiometry, which refers to the effort needed by the seedling to take up water regardless of the substrate's nature (Boudreau et al. 2006).

In Québec forest tree nurseries, TDR has been manually employed at an operational level using an MP-917 (E.S.I. Environmental Sensors Inc., Victoria, BC, Canada) fitted with probes specifically adapted to small cavities and peat substrates (Gagnon and Girard 2001; Lambany et al. 1996, 1997; Lamhamedi et al. 2001). At an experimental level, a wireless sensor network (WSN) of microtensiometers (Hortau, Saint-Romuald, QC, Canada), usable in cavities having a volume higher than 300 cm³ (18.3 in³), was also tested (Boudreau et al. 2006). In a forest nursery context, TDR and tensiometry are expensive and provide a poor sampling rate (1 to 10 small cavities per measurement). As a result, the measurement of substrate VWC in Québec forest nurseries is currently carried

out by manually weighing individual containers with a fish scale. By using this method, each gravimetric measurement takes into account between 25 and 67 cavities, depending on the container type.

In Québec, the seasonal evolution of dry mass of conifer seedlings has been monitored since the 1980s for almost every crop, creating a robust database. Thus, a representative profile of the seasonal dry mass evolution has been established for most seedling crop types. For conifer species produced in Québec, the fresh mass of seedlings follows a seasonal profile that is relatively close to that of their dry mass, with a “fresh/dry” ratio of between 3 and 5 (Girard et al. 2011). Using the IRREC software (Girard et al. 2011), the final substrate VWC is obtained by subtracting every known mass that is not substrate water.

Because any manual measurement consumes both time and money, it would be profitable to have an automatic system to reduce monitoring costs. Capacitance sensors, like the EC-5 (Decagon Devices, Inc., Pullman, WA), produce a direct measurement of substrate VWC. They are adapted for the large pots over 1,000 cm³ (61 in³) used in ornamental nurseries, where they can be used in conjunction with WSN (Hoskins et al. 2012). These sensors, however, are not appropriate for the small cavities used in forest nurseries (50 to 350 cm³ [3.05 to 21.36 in³]). Considering the small market and specificity of forest nurseries, a “do it yourself” (DIY) option, incorporating WSN, seems to be an efficient option for substrate VWC monitoring.

Arduino (Ivrea, Italy), a relatively new open-source tool, provides an opportunity to easily develop an efficient solution for forest tree nurseries. Arduino is a popular development platform based on a microcontroller (a kind of “nano” computer that analyzes and generates electrical signals) that can be connected to many peripherals (like weight sensors and radios used in our application). For example, this technology has been used to build a low-cost automated system for monitoring soil moisture and controlling irrigation designed for greenhouses in an ornamental nursery context (Ferrarezi et al. 2015, van Iersel et al. 2013). Arduino technology and Fritzing software (Potsdam, Germany) for printed circuit board (PCB) design

have been used to conceive a homemade PCB that respects the constraints intrinsic to a system developed for use in forest tree nurseries.

Those constraints include the following:

- Scales must be powered by cells that can last for a growing season.
- Scales must provide precise measurements, regardless of ambient temperature, while being stable throughout the season.
- Data transmission capacity must extend over the entire area of a large nursery.

The development context shown here is an example that is specific to the operational constraints of Québec forest nurseries. It can be easily adapted to any other context just by choosing adapted load cells (mass sensors) and container support beds, with an appropriate microcontroller programming.

Hardware Development

Wireless Network

The network uses three kinds of devices (figure 1).

1. Up to nine stand-alone electronic scales at the source of substrate VWC measurement (figure 2) can be grouped into a cluster (like children of a family).
2. Routers at the center of each cluster (powered by a solar shield [figure 3]) act as a parent for the scales of the cluster and broadcast the data from each individual scale over the network. Each router also relays data from nearby routers in the network (even if no scale is attached to it) to a single receiver.
3. A single receiver at the office (figure 4) is connected to a computer that uses weight data to calculate a substrate VWC for each scale and shows the substrate VWC monitoring results. The receiver also acts as a stand-alone datalogger that stores the basic weight values on a Secure Digital (SD) memory card.

All devices of the network (scales, routers, and the receiver) are linked together using the same model of radio modem for each device (XBP-24-BZ7SIT-004,

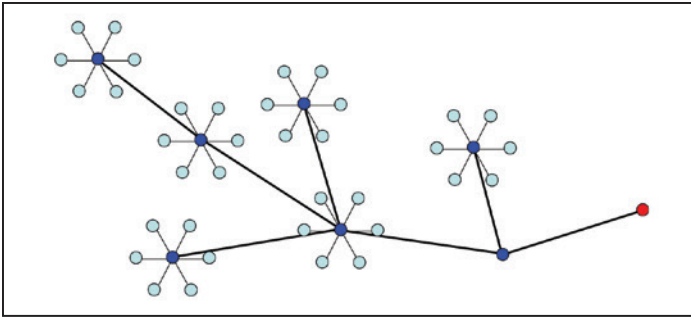

Figure 1. Example sketch of a wireless network (cluster tree type). Stand-alone scales (light blue) are powered by cells, and routers (deep blue) are powered using a solar shield. Each router relays the scale data in multiple hops (of no more than 200 m [610 ft] each) to expand the global network range to a single receiver (red) located at the nursery office.

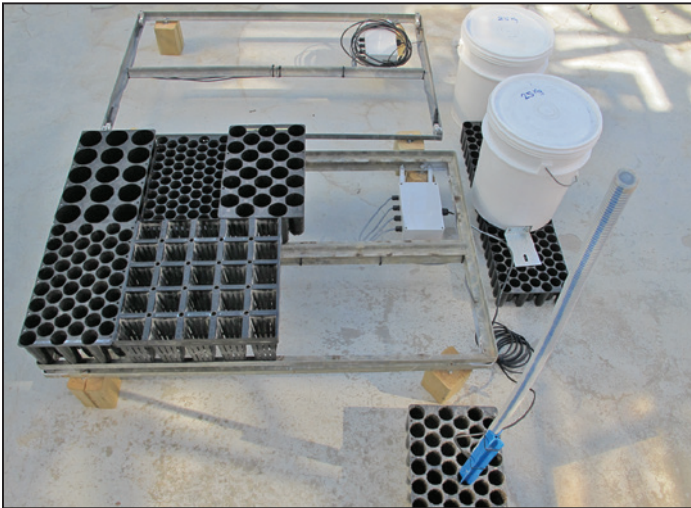

Figure 2. A stand-alone field scale with different container types used in Québec forest nurseries. A watertight enclosure fixed under the scale contains the power source for one growing season and all electronic scale components (microcontroller, amplifier, radio modem, etc.). The only external component is the radio antenna (in front, mounted in a flexible tube that bends when the irrigation boom passes over it) connected to the radio via a 3 m (9 ft) cable, allowing for optimal positioning for radio transmission efficiency. After the scales are installed in the field, they will work without maintenance for the entire growing season, producing real-time weight data at regular intervals determined by the grower (between 15 and 120 minutes). On the right of the scale are two identical 25 kg (55 lb) home-made weights used for initial calibration. In the back is a scale without an upper bed. (Photo by Daniel Girard, 2016)

Digi International, Inc. [Digi] Minnetonka, MN), programmed using X-CTU software (Digi, Minnetonka, MN), which is the only proprietary computer software used in our design (but which is available free to download for use with Digi radio modems for Windows, Mac, or Linux). After the radio modems are programmed suitably for each kind of device, they manage transparently the data routing over the network to the receiver using ZigBee protocol (ZigBee Alliance).

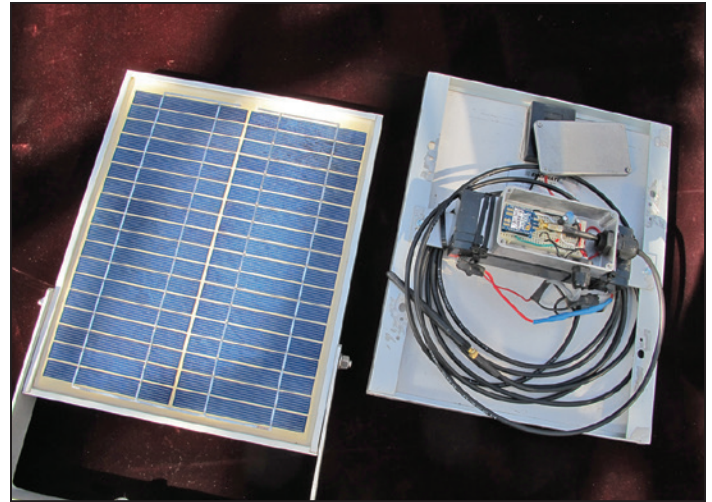

Figure 3. A low-cost, stand-alone, solar-powered router (both top and bottom) that uses a 2.3 Ah lead acid 12 V battery charged by a basic 10 W solar shield. The solar shield uses no costly charging regulator, only a diode to avoid battery discharge into the solar shield during the night. With the constant power demand from the radio, the battery will never be overcharged. (Photo by Daniel Girard, 2016)



Figure 4. Receiver (stand-alone datalogger) connected to a computer to show in real time the incoming weighing data. (Photo by Daniel Girard, 2016)

Wireless Range

With the low measurement rate (from 15 to 120 minutes for a scale) used in our application, it is preferable to use the lowest possible baud rate to maximize the wireless range. Therefore, the slowest possible baud rate for the Digi radio modems was chosen (1,200 baud).

For the scales and routers in the field, antennas are usually located 1.0 to 1.5 m (3.3 to 5.0 ft) above ground (figure 2). Therefore, the 2.4 GHz band is

preferable for our application because it performs well close to the ground. Moreover, 2.4 GHz radios are usually less expensive than 900 MHz radios (the other common alternative). Based on the results obtained from a field test at Grandes-Piles governmental forest nursery (ministère des Forêts, de la Faune et des Parcs, MFFP du Québec, Québec, Canada, 46°43'56" N., 72°42'06" W.) with a basic network (figure 5), a range of 200 m (656 ft) between router antennas—and between child scales and their parent router—can be effective if no more than one wind-break is located between the antennas. This distance takes into account the fact that wireless transmission efficiency can vary considerably, depending on the surrounding environment (temporary obstructions like vehicles, weather, etc.). Regardless of field configuration, 100 percent efficiency cannot be guaranteed. So, it is a good idea to consider using extra routers to secure data transmission.

One of the most basic considerations is the positioning of the antenna to account for the physical configuration of the field for an optimal efficiency of radio

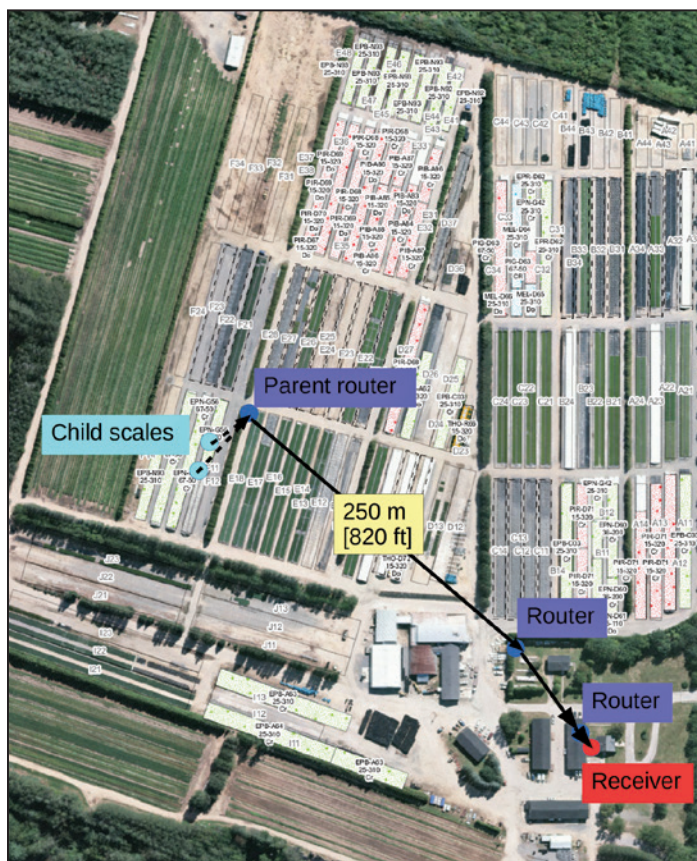

Figure 5. Aerial view of Grandes-Piles nursery, Québec, Canada, depicting wireless network scale range obtained in the field. (Extracted from ArcGis by Chantal Pelletier, Grandes-Piles nursery, 2014).

transmissions. Antennas ideally should be placed to get a direct view from one antenna to the next. To obtain the best possible place for wireless transmission, scale antennas can be placed from 3 to 5 m (10 to 16.6 ft) around the scale. Suitably positioned antenna devices result in the highest probability of efficient wireless data transmission.

Electronic Scale

At the locations of substrate VWC measurement in the nursery, each scale uses two identical steel nursery beds (commonly used to support containers in Québec forest nurseries) placed on top of each other and separated by four load cells of 50 kg (110 lb) capacity each (figure 2). The lower bed is supported by four adjustable feet for height setting and horizontal adjustments. The four load cells are fixed at each corner of the lower bed (figure 6). The upper bed that supports the containers is placed on the four load cells. The theoretical maximum load is 200 kg (440 lb), but the maximum load in the field does not exceed 75 kg (165 lb), with a usual load of around 40 kg (90 lb). Depending on the container type, each scale can sample 150 to 670 cavities, having volumes ranging between 50 and 350 cm³ (3.05 and 21.36 in³) (figure 2). Figure 7 illustrates the basic components and operation of a scale and also shows how it can produce a basic weight value using an Arduino-based microcontroller (Ivrea, Italy). Figure 8 shows the assembled electronic components that convert the analog signal from the load cells into a digital wireless signal with the process shown in figure 7.



Figure 6. One of the four low-cost load cells used for a scale (bending beam type, protected by a simple coat of aluminum-based paint) after a growing season in the forest nursery. A 3.2 mm (0.125 in) spacer is needed between the lower bed and the load cell, and a 19 mm (0.75 in) spacer is required between the other side of the load cell and the upper bed to mechanically insulate the beam from any unwanted contact. Mass applied on the upper bed induces invisible deformations on the beam that are perceptible by strain gauges applied on it. The initial result is a variable electrical signal (voltage) that is linearly related to the containers' mass. (Photo by Daniel Girard, 2014)

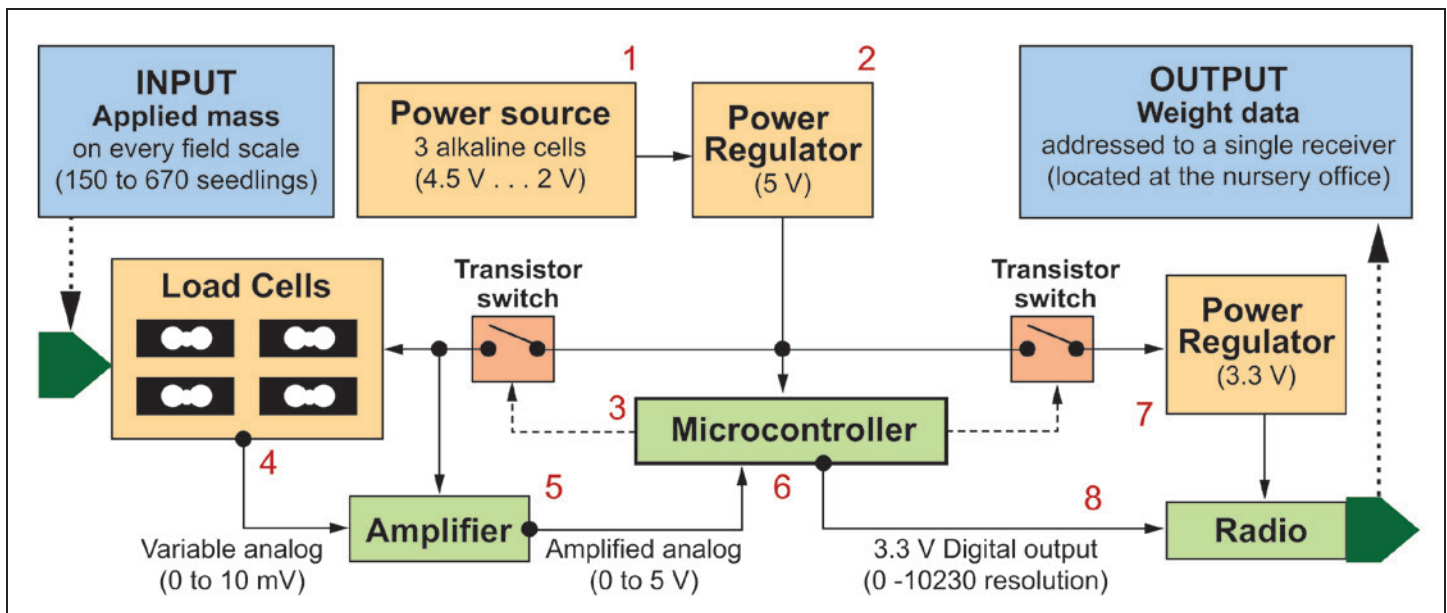

Figure 7. Simplified sketch of scale operation: (1) the scale is powered by three alkaline cells; (2) using a step-up regulator, cell power is boosted to a regulated 5 V to provide a stable analog measurement for the load cells and proper operation of the microcontroller; (3) the microcontroller, which drives all measurement processes, turns on the load cells and instrument amplifier using a transistor switch momentarily to save power; (4) load cells return a small variable output ranging from 0 to 10 mV, depending on the mass applied on the scale; (5) this small output is multiplied proportionally by the amplifier to a 0 to 5 V analog signal that is readable by the microcontroller; (6) the microcontroller converts the analog incoming signal into a basic digital form and, according to internal calibration values (easily set by the user once a year), to a common weight unit (decagrams for our example); (7) then, the microcontroller powers the radio for the few seconds that are needed for the data transmission process via another transistor switch and a step-down 3.3 V regulator (power level needed for radio); (8) at the same time, the microcontroller sends the digital weight value (in decagrams) to the radio, which broadcasts the data through the wireless network. Thereafter, to save power, the microcontroller shuts everything off and falls into a deep sleep mode until the next measurement. Thus, three alkaline cells can last for an entire growing season (references for scale components are provided in table 1).

Load Cells

Low-cost load cells (sensors at the source of measurement) offer a typical accuracy sufficient for substrate VWC monitoring in forest tree nurseries. Also, at less than \$10 (U.S.) each, they are 10 to 50 times less

expensive than calibrated load cells. Because they are delivered without significant quality control, however, quality control is necessary before assembly (it takes only few minutes per load cell). Up to half of the load cells may be rejected, in part, because of the use of oversized load cells to reduce creeping for our nursery application (see subsequent section on Laboratory Tests). After the quality control steps are rigorously completed, the scale can be assembled and its function should be successful, while keeping a low overall cost.

Scale Calibration

Scales that use low-cost load cells must be calibrated individually. Because the relationship between the electrical output of the load cells and applied load is almost linear, a manual calibration can be simply performed by using two identical calibrated weights of 25 kg (55 lb) each (figure 2). The calibration process is guided by blinking light-emitting diodes (better known as LEDs) on the scale assembly. The result is recorded in the microcontroller's permanent memory. During this process, ambient temperature reference is also recorded using an inboard

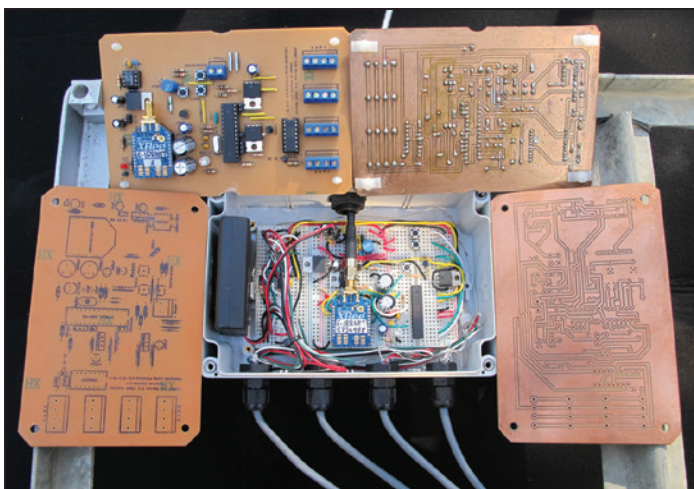

Figure 8. The stand-alone scale uses a homemade printed circuit board (PCB) based on Arduino (Ivrea, Italy). First, a draft circuit (in the grey box) was made and tested under field conditions using a solderless board. Thereafter, a homemade PCB was designed and assembled (around the grey box: different production phases). (Photo by Daniel Girard, 2016)

LM335 thermistor (Texas Instruments, Inc., Dallas, TX) to adjust future readings under different temperature conditions.

Laboratory Tests

Because temperature can affect load cell measurement (Prehn et al. 2010) and other electronic scale components, a stable mass of 25 kg (55 lb) was measured in a temperature-controlled environment at 24 °C (75 °F) and 4 °C (39 °F) over 48 hours (figure 9). An inboard temperature sensor (LM335, Texas Instruments, Dallas, TX) and microcontroller programming serve to reduce the temperature effect on electronic components to a nonsignificant variation.

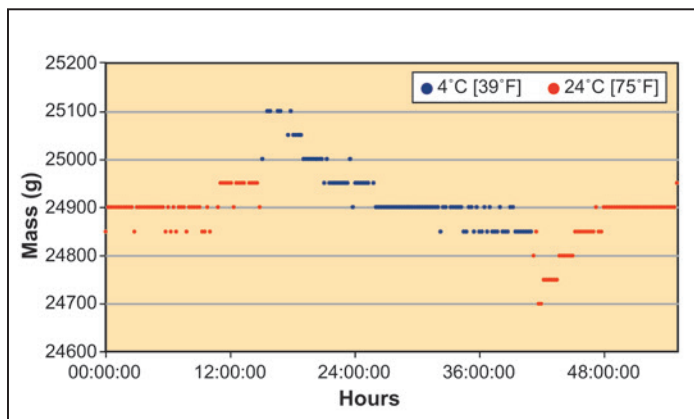

Figure 9. An abrupt temperature change under laboratory conditions (from 24 °C to 4 °C [75 °F to 39 °F] and back to 24 °C) shows the need for compensation. Using the onboard mounted thermistor, the temperature compensation leads to a maximal instant drift of 200 g (6.6 oz) (meaning around 0.5 percent of substrate volumetric water content). Because of different thermic characteristics of the scale components, however, complete temperature compensation after an abrupt change may need up to 6 hours to reduce drift under 0.5 percent. In the field, however, temperature changes are expected to be progressive.

Creeping is a progressive overestimation of the mass resulting from a structural fatigue of the load cell under application of a constant mass. In the load cell data sheet (Phidgets, Inc., Calgary, AL, Canada), creeping is expressed hourly, when the load is close to the maximum capacity. Because scales have to support a significant load for an entire growing season, this phenomenon was measured by applying a stable mass of 68.2 kg (151 lb) (representing around 175 percent of the usual load of a scale during a 7-day period). The selected load cells have an oversized capacity that is around 300 percent of the maximum anticipated load, which reduces the creeping effect to a nonsignificant 0.25 percent of substrate VWC per season (figure 10).

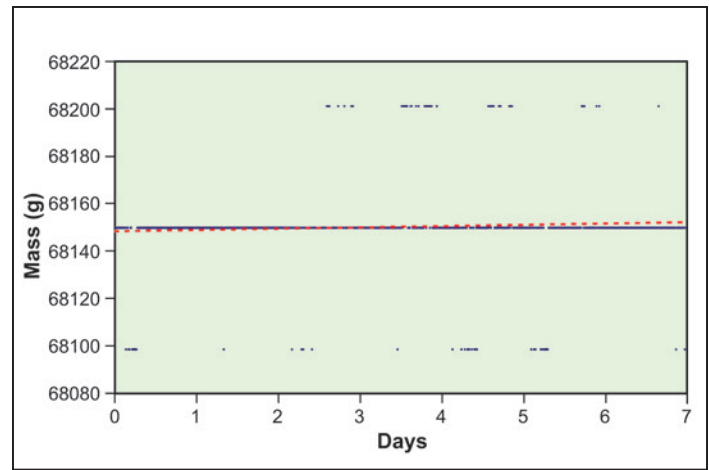

Figure 10. The mass overestimation that is generated by creeping represents 0.546 g (0.0182 oz) per day (red dashed line) meaning around 100 g (3.33 oz) for a 200-day growing season. This estimation represents less than 0.3 percent of substrate volumetric water content and is nonsignificant. Thus, the scale has to be calibrated only once a year. (Note that steps between levels of the blue dots represent the resolution of the scale.)

Power Autonomy of Stand-Alone Scales

Scale power consumption was reduced by programming the shortest possible use of power-draining devices (load cells and radio) using JeeLib Arduino library (JeeLabs, Houten, Netherlands). For scales that perform one measurement every 15 minutes, three AA alkaline cells last approximately 3 months, at an average temperature of 16 °C (61 °F). If more autonomy is needed, C alkaline cells can be used. Programming a larger elapsed time (up to 120 min) between measurements is also a solution to using AA cells. For scales, cell powering is a low-cost solution compared with the use of solar shields with 12 V battery or of an outlet with a long cord.

Routers

Routers must be awakened to receive a signal from a scale. A 2.3 Ah 12 V battery with a 10 W-12 V solar shield with a diode (that avoids battery discharge into solar shield during night) can maintain enough power for a standard cluster (up to 9 scales) and a small network (up to 24 scales), while keeping the battery integrity (figure 3). For larger scale networks, the use of 20 W (or more) solar shields and costly power regulators should be considered. Thus, if AC power is available in the nursery, it is preferable for routers.

Receiver

The receiver, located at the nursery office (figure 4), gives a time stamp (date-hours-minutes) to each incoming weight datum, using a real-time clock, and associates it with each individual scale of the network before recording all data on an SD memory card. The receiver is a stand-alone datalogger but it can be connected to a personal computer (PC) (Windows, Mac, or Linux) to show incoming data in real time using the Arduino serial monitor (Ivrea, Italy) and companion software.

Field Considerations

Installing a scale network in the field requires some precautions. Electronic components must be protected using desiccant inside watertight enclosures. Also, to provide an efficient protection against lightning, grounded metallic enclosures are recommended. For battery-powered scales, installation of an individual ground is highly recommended. In some environments, cables also need to be protected against rodents.

Assembly and Cost

All the components needed to build the wireless network of electronic scales (table 1) are easily available at a relatively low cost. Some specific components, which are not available at a local electronics shop, can be easily ordered from Web sites of electronic hardware providers. Specialized manufacturers can produce a basic PCB at a relatively low cost based on standardized instruction files generated by PCB design software (called Extended Gerber RS-274X). Assembling is accessible to a good tinkerer, but, obviously, this is not a “plug-and-play” solution. Most growers may not feel comfortable with assembling this system. Because hardware and software designs are “open source,” however, growers can freely get help from local resources that can build the hardware for them. Most of the needed resources are available on a file transfer protocol—FTP—site (<ftp://ftp.mrn.gouv.qc.ca/Public/Drf/IRREC/>) or by contacting the first author of this article.

Table 1. Main electronic components used by each of the three types of devices of the wireless network of electronic scales. Note that these components also need many secondary generic components (antenna cable, resistor, capacitor, diode, inductor, etc.), which are not listed in this table. The total material cost for each device is approximately \$150 (U.S.).

Component	Model	Manufacturer
Scale		
Printed circuit board (PCB)	Home design	Miscellaneous
Switching step-up 5 V regulator	LT-1302	Linear Technology Corporation, Milpitas, CA
50 kg load cell	P/N 3135_0	Phidgets, Inc., Calgary, AL, Canada
Microcontroller	Atmega328P-PU	Atmel Corporation, San Jose, CA; Arduino, Ivrea, Italy
Instrument amplifier	INA125P	Texas Instruments, Dallas, TX
Transistor switch (MOSFET)	IRF520	International Rectifier (Infineon), El Segundo, CA
Linear step-down 3.3 V regulator	LM3940	Texas Instruments, Dallas, TX
Radio modem (XBee)	XBPBZ7SIT-004	Digi International, Inc., Minnetonka, MN
Antenna	A24-HASM-450	Digi International, Inc., Minnetonka, MN
Router		
PCB	Home design	Miscellaneous
Switching step-down 3.3 V regulator	LM2675	Texas Instrument, Dallas, TX
Radio modem (XBee)	XBPBZ7SIT-004	Digi International, Inc., Minnetonka, MN
Antenna	A24-HASM-450	Digi International, Inc., Minnetonka, MN
Solar shield	10W	Miscellaneous
Receiver		
Microcontroller board	Arduino UNO,R3	Arduino, Ivrea, Italy
Shield	Arduino XBee-SD	Arduino, Ivrea, Italy
Radio modem (XBee)	XBPBZ7SIT-004	Digi International, Inc., Minnetonka, MN
Antenna	A24-HASM-450	Digi International, Inc., Minnetonka, MN
Real-time clock	BB-DS3231	Cytron Technologies, Pulau Pinang, Malaysia

In 2015, a scale was assembled for around \$150 (U.S.) of materials and 4 hours of labor. The material cost for the other individual devices (routers and the receiver) was also \$150 (U.S.) each, and each required 2 hours of labor. For a global DIY network like the one shown in figure 1 (36 scales, 7 routers, and a receiver), the material cost is around \$6,600 (U.S.) and requires about 160 hours of labor.

Despite the initial material and labor costs, wireless electronic scales can be profitable, because they greatly reduce labor and skills required in the forest nursery. In addition, risks of injuries to workers (including chronic injuries caused by repetitive movements like container lifting) can be reduced and data quality improved.

Operational Use

Calculating VWC From Container Weights

To obtain the substrate VWC (based on the water mass [1 g = 1 cm³]), everything that is not substrate water mass must be subtracted from the basic container weight. First, the stable mass (container, dry substrate, and protective grit placed over the seeds at sowing) can be easily determined. Establishing the seedlings' fresh mass is more complicated, which is why tools based on the seasonal evolution of the standard for seedling dry mass have been developed for the IRREC irrigation software (Girard et al. 2011). These tools are used to reliably estimate the mass (stable and variable) that has to be subtracted from the total weight. Figure 11 shows how the mass that is not attributable to substrate water is established using automatic calculations. These calculations provide an automatic seedling fresh mass estimation over the growing season, simply by providing a sampling date. Using this calculation method, the error percentage is usually smaller than +/- 2.5 percent of VWC, even with large seedlings.

Here is an example for large white spruce (*Picea glauca* [Moench] Voss) seedlings produced in a 15-320 container (15 cavities of 320 cm³ [19 in³] each):

1. For a final dry mass target of 10 g (0.33 oz), an error of +/- 20 percent (8 to 12 g [0.27 to 0.4 oz]) is equivalent to +/- 2 g (0.067 oz) per seedling.
2. Applying an oversized fresh/dry ratio of 4 times results in an error of +/- 8 g (0.27 oz) per seedling.



Figure 11. For each scale, the mass that is not substrate water is predicted by simulation for each day of the upcoming growing season. (1) A general profile is set for the seasonal evolution of dry mass, from 0 to 100 percent of the final value, using tools in the grey section. Thereafter, the beginning and the end of the growing season are established to fix the x-axis for the nursery. (2) To obtain the fresh mass, a standard “fresh/dry” ratio of 3.5 can be used, but up to five seasonal evolution profiles of fresh/dry ratios can be established according to the genus of seedling crop (*Picea*: EPN, *Pinus*: PIG, *Larix*: MEL, etc.) to give more precise results. (3) The profile of the dry mass is adjusted according to the targeted dry mass values for the crop of each scale (y-axis). All other parameters (grey zone, red characters) are taken into account to calculate the mass that is not substrate water for every scale and for each day of the growing season (purple zone). Note that all values shown in the third section are given by spreadsheet formulas. In the next step (figure 12), these data will be used to easily produce and show the volumetric water content of the substrate.

3. With 320 g (10.67 oz) of water mass per cavity, the usual error is $8/320 = \pm 2.5$ percent of the final substrate VWC result.

With no significant seedling mass, the error is under 1 percent of substrate VWC.

Companion Software Used To Show the Substrate VWC

Until now, we have kept the system as simple as possible in terms of programming, compatibility, and stability. The receiver can act as a stand-alone datalogger, keeping the WSN separate from the PC for daily use. The use of an SD memory card to store incoming data provides an easy way to transfer data to the PC. Stability is an important consideration if the network has to operate for many months without intervention. To get the best stability possible, watchdog functions have been programmed to reset the

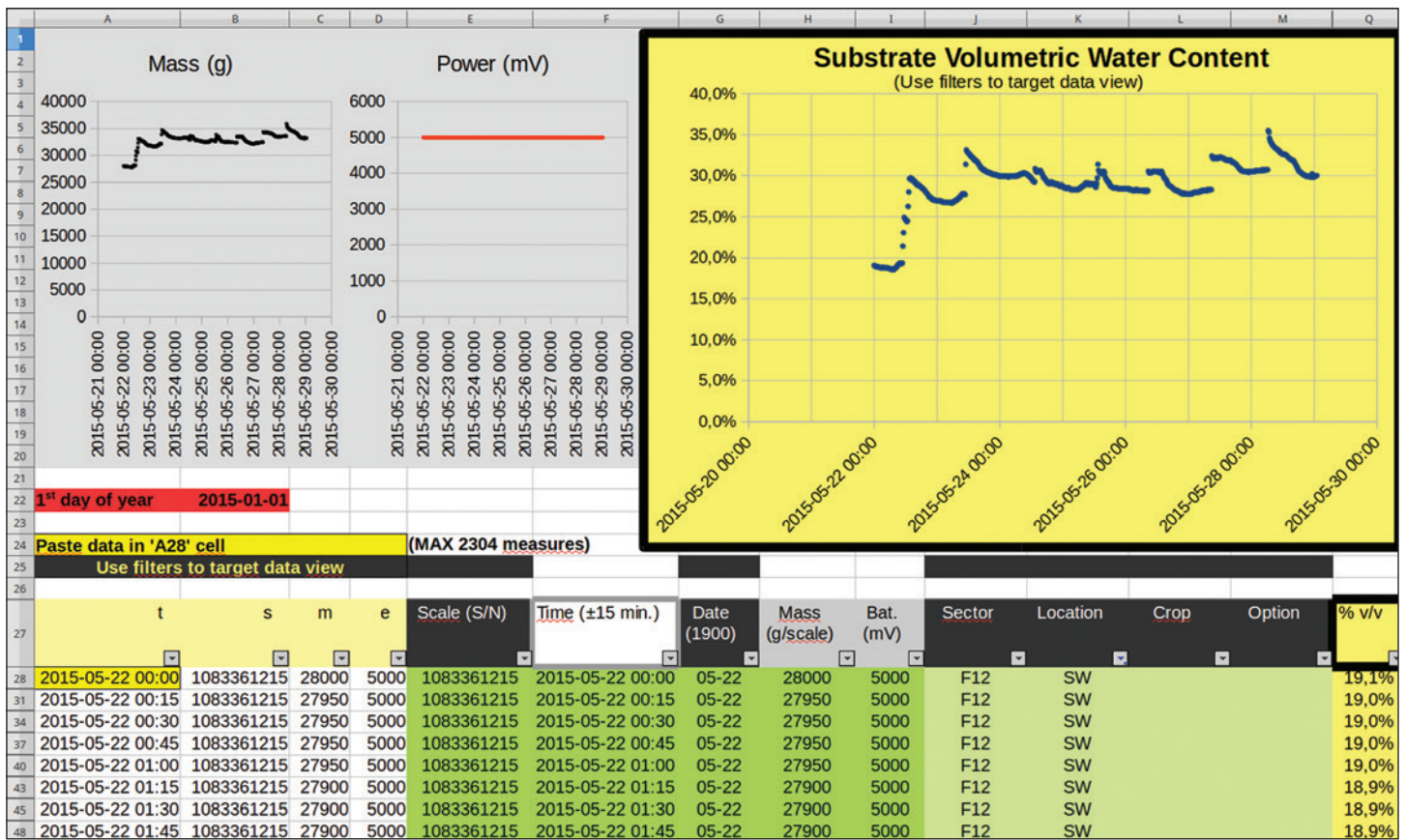

Figure 12. An example graph of substrate volumetric water content monitoring (yellow) obtained at Normandin nursery (Québec, Canada). Other graphs (from left to right) represent basic weight (in g) and cell power level (in mV), respectively. All graphs are based on the individual values shown in the table.

microcontroller in case of an infinite loop generated by an unexpected bug. To date, direct communication between the receiver’s microcontroller and the PC via a USB cable is possible only under Linux and requires some basic skills to use.

Spreadsheets used for companion software permit easy computer software development, but they are not efficient for daily calculations. Thus, the companion software uses two spreadsheets (based on LibreOffice Calc spreadsheet software, Berlin, Germany) to provide faster daily calculations. The role of the first spreadsheet (figure 11) is to build a table of the mass values that are not attributable to substrate water for each scale (associated with a crop) and for each day of the growing season. These calculations are complex and time consuming, but they have to be done only once, at the beginning of the season (or only if parameters change significantly during the season). The “non water” table numeric values are copied to the second spreadsheet (figure 12) to be used in a quick calculation process to determine substrate VWC.

Advantages of Container Weighing

The sampling rate of hundreds of seedlings using gravimetry (figure 13) is more statistically adapted to the forest nursery context than using other methods

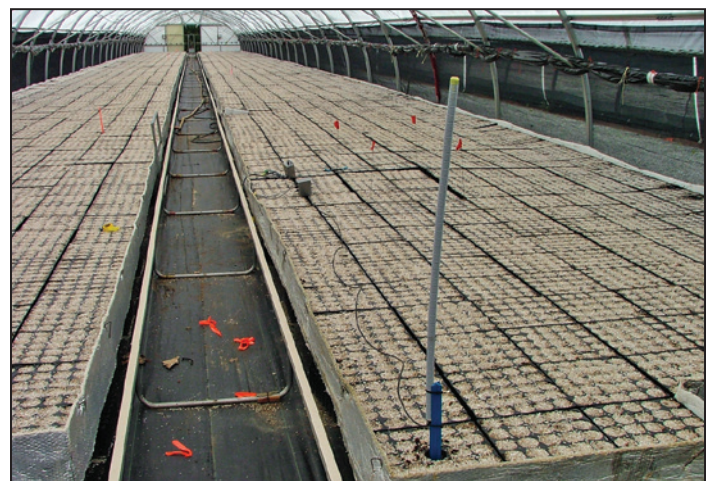

Figure 13. A scale (between the red flags) installed in a crop of seedlings grown in “25-310” type containers (25 cavities with a volume 310 cm³ (19 in³) each, IPL 25-310 (Saint-Damien, Québec, Canada) at Grandes-Piles nursery. In front is the same antenna that was shown in figure 2. Few scales may be needed to obtain a robust statistical base for efficient irrigation management in a crop area. (Photo by Daniel Girard, 2014)

(TDR, tensiometry, or capacitance) that usually sample only single seedlings or never more than 10 seedlings per measurement.

For seedlings in the active growth phase, accuracy depends more and more on the fresh weight of seedlings, but for germinating seedlings (with no significant added mass), small variations in substrate VWC are easily detectable using container weighing. Detecting these variations can be a major help in reducing fungal disease while increasing germination efficiency.

Conclusions

This article describes development of a low-cost, automated monitoring system for determining substrate VWC. Although hardware and software proposed for wireless electronic scales are very basic, scales can operate well and will allow growers to improve the irrigation management of their crops. Open source electronic design and software provide an interesting way for markets like forest nurseries to access these new technologies. The principles used for this development can be adapted to other field configurations (other bed types or individual container sampling) by using other load cells and adapted microcontroller programming.

With this system specifically designed for forest nurseries, it is possible to use WSN technology for gravimetric measurements. Indeed, the overall measurement accuracy is the best that can be obtained today for monitoring substrate VWC in forest nurseries. A DIY automated electronic scale can easily give a +/- 1 percent (v/v) resolution of substrate VWC. Even when the bias generated by seedling wet weight estimation (no more than +/- 2.5 percent, using calculation methods of the IRREC irrigation software; Girard et al. 2011) is taken into consideration, gravimetry is still the best method for measuring substrate VWC because it allows a great sampling rate (more than 100 seedlings at a time). Wireless electronic scales can be considered as a necessary evolution, leading to more efficient irrigation scheduling and the production of better quality seedlings with less impact on environmental quality by avoiding excess irrigation (water economy) and reducing nutrient leaching.

Acknowledgments

The authors thank the staff of Québec Government forest nurseries at Grandes-Piles (Josée Houde, Sylvie Goulet and Chantal Pelletier) and Normandin (Pierre Comtois and Guy Marineau) for their technical assistance. For the experiment at Normandin nursery, they also thank Pascal Desjardins and Patrick Lemay of the Direction de la recherche forestière (DRF) du Ministère des Forêts, de la Faune et des Parcs (MFFP) for the installation of the scales and Fabienne Colas (DRF) for her collaboration in this study. They also acknowledge Claire Filion, Arezki Ikerrouiene, and Patrice Tardif from the DRF for scientific support. The authors also thank Mohammed S. Lamhamedi (DRF) for his helpful advice and Michel Campagna (DRF) for the revision of this article. They thank Debra Christiansen Stowe for her revision and correction of the English version of this article. Finally, the authors acknowledge Diane Haase (editor of *Tree Planters' Notes*) for her suggestions and editorial comments. Financial support for this research project was provided to Jean Gagnon by the MFFP (project: 142332084).

The authors also thank all of the essential open-source resources used, notably Arduino (<https://www.arduino.cc>, Ivrea, Italy) and associated community, JeeLabs (<https://jeelabs.net>, Houten, Netherlands), Adafruit Industries (<https://learn.adafruit.com>, New York, NY), Fritzing (<http://fritzing.org>, Potsdam, Germany), and The Document Foundation for LibreOffice (<http://www.documentfoundation.org>, Berlin, Germany).

Address correspondence to—

Daniel Girard, Ministère des Forêts, de la Faune et des Parcs (MFFP), Direction de la recherche forestière, 2700, rue Einstein, Québec, QC, Canada G1P 3W8; e-mail: daniel.girard@mffp.gouv.qc.ca; phone: 418-643-7994 (ext. 6571).

REFERENCES

Arseneault, J. 2015. Personal communication regarding the number and species of containerized and bareroot seedlings produced in 2015 in forest tree nurseries of Québec. Forest Technician, Ministère des Forêts, de la Faune et des Parcs (MFFP), Direction

générale de la production de semences et de plants forestiers (DGPSPF), Québec City, Québec, Canada.

Boudreau, J.; Jobin, P.; Bettez, M. 2006. Nouvel outil de gestion de la tension et de la température du substrat. Affiche présentée au 4e atelier sur la production de plants forestiers au Québec : Facteurs et techniques culturales influençant le développement racinaire des plants en pépinière forestière. 15-16 mars 2006, Hôtel Clarion, Sainte-Foy, Québec.

Burnett, S.E.; van Iersel, M.W. 2008. Morphology and irrigation efficiency of *Gaura lindheimeri* grown with capacitance sensor-controlled irrigation. *HortScience* 43(5): 1555–1560.

Ferrarezi, R.S.; Dove, S.K.; van Iersel, M.W. 2015. An automated system for monitoring soil moisture and controlling irrigation using low-cost open-source microcontrollers. *HortTechnology*. 25(1): 110–118.

Gagnon, J.; Girard, D. 2001. Bilan des pertes saisonnières de nitrates (NO₃) et d'eau sous une culture d'épinette blanche 2+0 produite dans le récipient 25-350A. Ministère des Ressources naturelles, Direction de la recherche forestière. Rapp. Int. no 466. 36 p.

Girard, D.; Gagnon, J.; Lamhamedi, M. 2011. IRREC: Un système informatisé de calcul des besoins en irrigation pour les plants en récipients produits dans les pépinières forestières du Québec. Mémoire de recherche forestière no 162, Sainte-Foy, Québec, Canada: Ministère des Ressources naturelles, Direction de la recherche forestière. 54 p.

Hoskins, T.; Owen, J.; Stoven, H. 2012. Monitoring from a distance: using a remote moisture monitoring system to manage irrigation. *Digger*. 56(7): 41–44.

Lambany, G.; Renaud, M.; Beauchesne, M. 1997. Control of growing medium water content and its effect on small seedlings grown in large containers. *Tree Planters' Notes*. 48(3/4): 48–54.

Lambany, G.; Robidas, L.; Ballester, P. 1996. Measurement of soil water content in a peat-vermiculite medium using time domain reflectometry (TDR): a laboratory and field evaluation. *Tree Planters' Notes*. 47(3): 88–93.

Lamhamedi, M.S.; Lambany, G.; Margolis, H.; Renaud, M.; Veilleux, L.; Bernier, P.-Y. 2001. Growth, physiology and leachate losses in *Picea glauca* seedlings (1 + 0) grown in air-slit containers under different irrigation regimes. *Canadian Journal of Forest Research*. 31(11): 1968–1980.

Prehn, A.E.; Owen, J.S.; Warren, S.L.; Bilderback, T.E.; Albano, J.P. 2010. Comparison of water management in container-grown nursery crops using leaching fraction or weight-based on demand irrigation control. *Journal of Environmental Horticulture*. 28(2):117–123.

Topp, G.C.; Davis, J.L. 1985. Measurement of soil water content using time-domain reflectometry (TDR): a field evaluation. *Soil Science Society of America Journal* 49(1): 19–24.

van Iersel, M.W.; Chappell, M.; Lea-Cox, J.D. 2013. Sensors for improved efficiency of irrigation in greenhouse and nursery production. *HortTechnology*. 23(6): 735–746.