

Planting the

Southern Pines

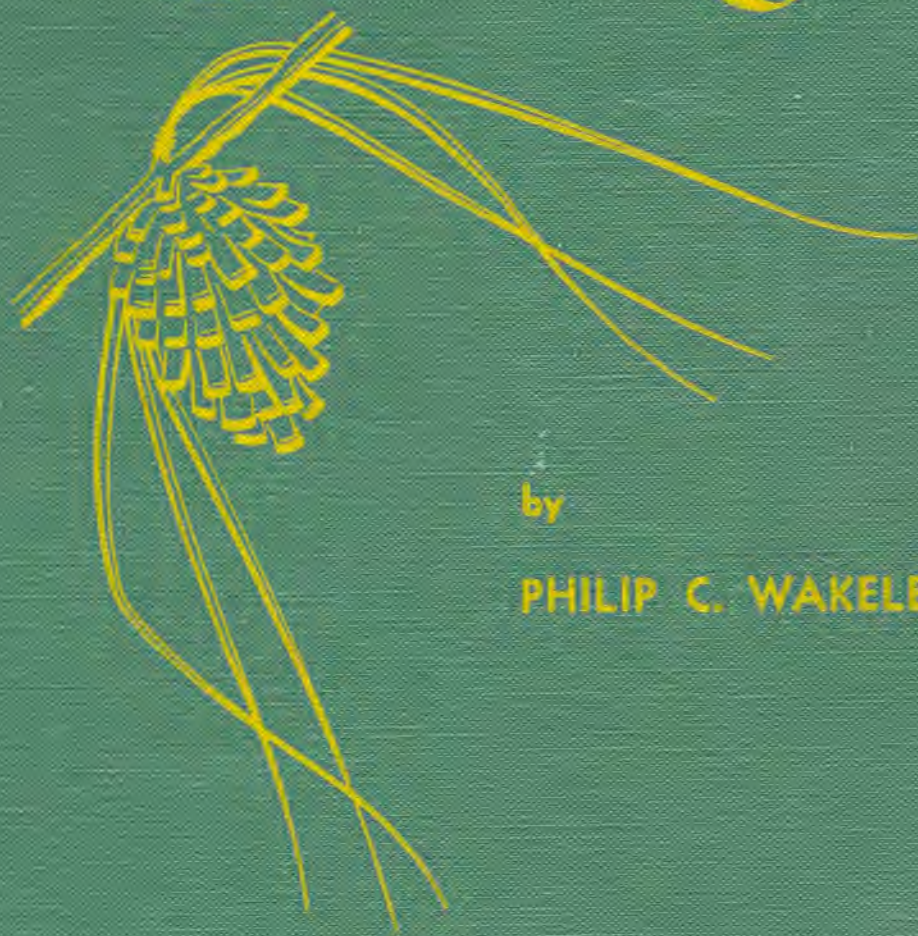

by

PHILIP C. WAKELEY

AGRICULTURE MONOGRAPH NO. 18

1954

FOREST SERVICE, U.S. DEPARTMENT OF AGRICULTURE

Planting the

Southern Pines

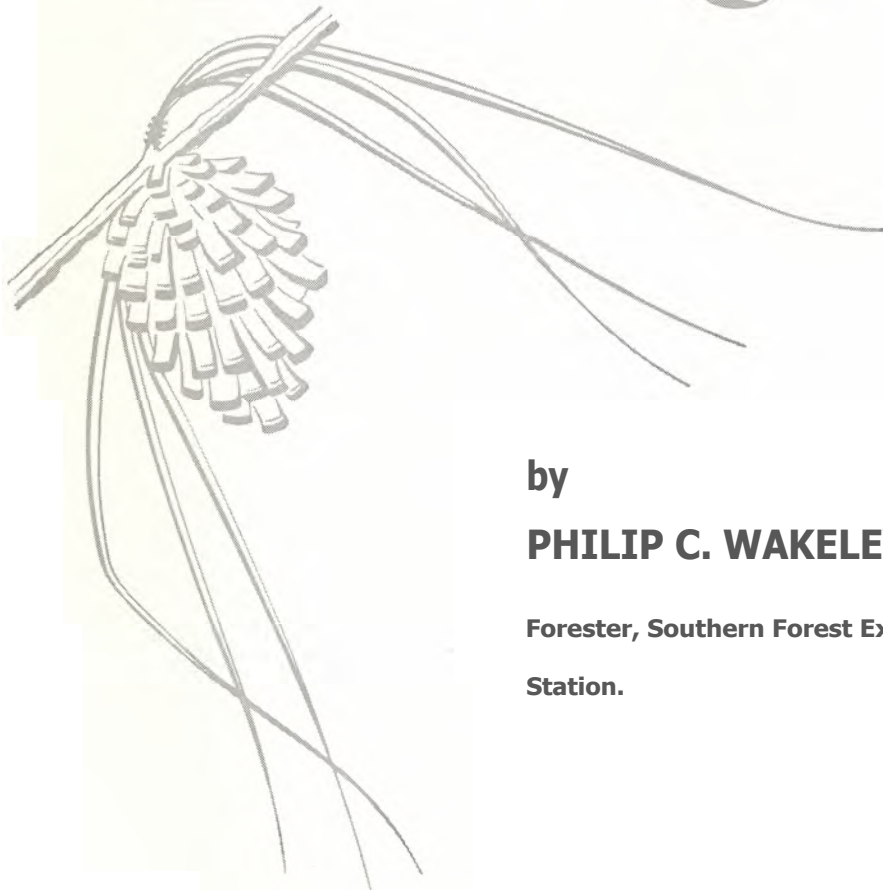

by

PHILIP C. WAKELEY

Forester, Southern Forest Experiment
Station.

Forest Service, U. S. Department of Agriculture, 1954

For sale by the Superintendent of Documents, U. S. Government Printing Office
Washington 25, D. C. - Price \$2.75

CONTENTS

	Page		Page
Introduction.....	1	Seed—Continued	
Planting policies.....	4	Storage—Continued	
Species characteristics that affect planting.....	4	Overwinter storage.....	49
Loblolly pine.....	4	Cold storage time schedules.....	52
Slash pine.....	4	Miscellaneous details of storage technique.....	53
Longleaf pine.....	5	Recommendations.....	53
Shortleaf pine.....	6	Pregermination treatments.....	54
Choice of species to plant.....	7	Dormancy.....	54
Geographic source of seed.....	14	Stratification.....	54
Planting versus direct seeding.....	16	Other pregermination treatments.....	56
Spacing at which to plant.....	18	Deciding when pregermination treatment is needed.....	56
Recommended spacings.....	20	Seed testing.....	57
Arrangement of trees in other than square spacings.....	22	Sampling.....	57
Means of obtaining planting stock.....	22	Percentage of seeds that contain kernels.....	59
What constitutes plantable land.....	23	Purity percent.....	60
Planting costs and plantation yields.....	23	Number of seeds per pound.....	60
Overall costs.....	24	Moisture content.....	61
Special costs.....	25	Germination tests.....	61
Plantation growth and yields.....	25	Reporting and interpreting results of seed tests.....	64
Records and local tests.....	26	Seed costs, purchases, sales, and records.....	65
Records.....	26	Costs.....	65
Local tests.....	27	Buying and selling seed.....	65
Safety.....	28	Records.....	67
Seed.....	29	Nursery practice.....	68
Seed development.....	29	Nursery site and layout.....	68
Seed production and yields.....	30	Location.....	68
Frequency and extent of seed crops.....	30	Capacity.....	68
Tree characteristics affecting seed produc- tion.....	31	Water.....	69
Yields per cone and per bushel.....	31	Topography and soil.....	70
Estimating cone crops.....	32	Nursery layout.....	70
Collection and care of cones.....	33	Sowing.....	71
Cone maturity.....	33	Season of sowing.....	71
Details of collection.....	34	Preparation of ground and seedbeds.....	71
Methods and equipment.....	34	Method of sowing.....	72
Labeling.....	35	Density of seedling stand.....	73
Care between collection and extraction.....	36	Sowing rate.....	74
Extraction.....	36	Mixing seed before sowing.....	75
Avoiding injuries to cones and seed.....	36	Seedbed covers.....	75
Precuring of cones.....	36	Watering, weeding, and related care.....	77
Extractory design and equipment.....	37	Watering.....	77
Air-temperature versus kiln extraction.....	37	Weeds.....	77
Kiln extraction.....	37	Indirect weed control.....	78
Tumbling of cones.....	40	Hand and mechanical weeding.....	78
Disposal of cones.....	40	Chemical weeding.....	79
Dewinging, cleaning, and drying.....	41	Shading.....	79
Dewinging.....	42	Seedbed cultivation.....	80
Cleaning.....	42	Normal development and growth.....	80
Drying.....	43	Nursery injuries and their control.....	83
Storage.....	45	Climatic injuries.....	83
Temperature, moisture, and containers.....	46	Birds, mammals, and crustaceans.....	85
Storage for one or more years.....	47	Insects and arachnids.....	85

Nursery practice—Continued	Page	Planting—Continued	Page
Nursery injuries and their control—Continued		Planting methods.....	133
Nematodes.....	89	Hand versus machine planting.....	133
Fungus and other diseases.....	89	Choice of hand tool.....	133
Mechanical injury.....	94	Planting with bar or mattock.....	135
Nutritional deficiencies and toxic effects.....	95	Opening and closing the slit in bar planting.....	135
Seedling inventory.....	96	Depth of setting.....	137
Lifting, culling, packing, and shipping.....	97	Skill of individual planter.....	138
Inspection and certification before lifting.....	97	Fertilizing the planting spot.....	138
Protective sprays and dips.....	97	Control of spacing.....	138
Lifting.....	98	Planting among pines or hardwoods.....	139
Grading and culling.....	98	Planting among pines.....	140
Counting.....	99	Planting among hardwoods.....	141
Packing.....	100	Planting costs, rates, and records.....	145
Root exposure, nursery storage, and shipment.....	100	Planting costs.....	145
Grades of nursery stock.....	102	Rates of planting.....	146
Morphological grades.....	102	Records.....	147
Success and failure of morphological grades.....	104	Plantation care.....	148
Critical test of morphological grades.....	105	Plantation injuries and their control.....	148
Physiological qualities.....	108	Fire.....	148
Recommendations.....	110	Climate.....	148
Nursery soil management.....	111	Soil.....	151
Seedling requirements.....	111	Animals.....	151
Effects of cropping system on soil.....	111	Insects.....	153
Keeping the soil in good physical condition.....	112	Diseases.....	157
Fertilizing and amending nursery soils.....	112	Replacement planting.....	164
Inorganic fertilizers.....	113	Selecting areas needing replacements.....	165
Green manure, cover, and catch crops.....	115	Replacements in longleaf plantations.....	165
Composts, organic supplements, and other soil amendments.....	116	Fertilizing and cultivating plantations.....	168
Mycorrhizae and soil management.....	118	Thinning and pruning.....	169
Immediate recommendations.....	118	Time of first thinning.....	169
Nursery costs and records.....	119	How much of a stand to leave.....	170
Planting.....	121	Arrangement of trees left.....	170
Planting surveys.....	121	Choice of trees to leave and to cut.....	170
The problem of initial survival.....	122	Pruning.....	171
Site preparation.....	123	Summary of important points.....	173
Burning.....	124	General policies.....	173
Furrowing.....	124	Seed.....	173
Scalping.....	125	Nursery practices.....	174
Subsoiling.....	125	Planting.....	174
Strip plowing.....	125	Plantation care.....	174
Special measures on severely eroded land.....	125	Literature cited.....	175
Brush elimination.....	125	Appendix.....	198
Allocation of treatment to site.....	125	Southern pine cone and seed data.....	198
Season and weather.....	126	Descriptions of experimental planting areas.....	198
Lifting and shipping dates.....	126	Bogalusa experimental plantations.....	198
Top dormancy.....	126	J. K. Johnson Tract plantations.....	200
Weather during planting.....	127	Plantations on the Harrison Experimental Forest.....	200
Condition and care of stock.....	128	Experimental plantations at Auburn, Ala.....	201
Root length.....	128	Safety rules for the use of insecticides, fungicides, baits, and repellents.....	202
Loss of lateral roots.....	128	Insecticides.....	202
Packing and transit.....	129	Multipurpose insecticides.....	203
Stock storage.....	129	Fumigants.....	205
Root exposure.....	130	Contact insecticides.....	206
Mechanical injuries during planting.....	131	Stomach poisons used mostly as foliage sprays.....	207
Special conditioning of stock.....	132	Stomach poisons applied as baits.....	207

Appendix—Continued	Page
Fungicides.....	208
Spreaders and stickers.....	211
Miscellaneous baits, repellents, and coatings.....	212
Mouse baits.....	212
Pocket gopher baits.....	213
Rabbit-repellent spray.....	213
Foliage coatings to reduce transpiration.....	213
Plant quarantine and nursery inspection officials.....	214
Wire screens to protect seed spots.....	214
Pine seed dewinger.....	215
Guide to drying of seed.....	216
Seed-sampling probes.....	217
Directions for germination tests.....	217
A. Facilities, material, and apparatus.....	217
B. Preparing sand flats.....	221
C. Setting up sand-flat tests.....	221
D. Preparing peat mats.....	221
E. Setting up peat-mat tests.....	222
F. Care of tests.....	222
G. Recording germination.....	222
Acidification of nursery soil to control damping-off.....	223
Directions for seedling inventories.....	224
A. Equipment and materials.....	224
B. Preparation for sampling.....	224
C. Making sample counts.....	224
D. Calculating the number of living seedlings.....	225

Appendix—Continued	Page
Directions for seedling inventories—Con.	
E. Calculating the number of plantable seedlings.....	225
Directions for preparing compost from rice or other straw.....	225
Directions for heeling-in seedlings.....	226
Directions for baling seedlings.....	227
A. Equipment.....	227
B. Material per bale.....	227
C. Baling.....	227
Directions for correct planting with hand tools.....	227
Bar planting with standard bar and Ehrhart tray, each man carrying and setting his own trees.....	228
Bar planting with standard bar, men working in pairs.....	228
Mattock (grub hoe) center-hole planting.....	228
Mattock (grub hoe) side-hole planting.....	229
Mattock (grub hoe) slit planting with narrow-bladed tool in light soil.....	230
Mattock (grub hoe) slit planting with broad-bladed tool in heavy soil.....	231
Directions for control of pocket gophers.....	231
Trapping.....	232
Poisoning.....	232
Directions for control of Texas leaf-cutting ants.....	232
Treatment with methyl bromide.....	232
Treatment with carbon disulfide.....	233

INTRODUCTION ¹

Planting the southern pines offers the only sure way of restoring to timber production, within the next 50 years, a huge area of forest land vital to the southern and the national economy.

By conservative estimate, the area in the South still in need of planting is 13 million acres, nearly all of which (755)² should be planted with the southern pines (table 1). Every State from Virginia to Texas has substantial areas of land which should be planted for timber production or erosion control. Much is on farms and much is industrially owned. A very sizable part is in the hands of small investors, and some is in public holdings. In brief, planting is almost everybody's business.

Large-scale planting of southern pines did not

get under way until the 1920's. A few small plantations had been established before 1900, but the total area successfully reforested by 1920 probably did not exceed 500 acres. In the middle and late 1930's the planting effort was greatly speeded up, and since World War II the annual rate of planting has exceeded that of the best prewar years. The planting that has been done so far has accomplished only about one-tenth of the whole job.

Planting the huge acreage that remains will be no simple or easy task, but experience has shown that it can be done, and at a reasonable cost. Southern pines are hardy species, adapted to grow vigorously on sites unfavorable for many other plants, and remarkably able to resist or recover from injury. Common sense, observation, and hard work led the early planters to some notable successes (fig. 1). Today's planters have one additional resource—a considerable body of knowledge and skill drawn from research and practice.

¹This monograph supersedes U. S. Dept. Agr. Tech. Bul. 492, Artificial Reforestation in the Southern Pine Region.
²Italic numbers in parentheses refer to Literature Cited, p. 175.

TABLE 1.- Estimated are in the South which should be planted,¹ by major forest types

State or region	Idle or abandoned farm land ²	Forest land, by major forest types				Total farm and forest land
		Longleaf; longleaf-slash	All loblolly and shortleaf types ³	Upland hardwood	Bottomland hardwood	
	<i>Acres</i>	<i>Acres</i>	<i>Acres</i>	<i>Acres</i>	<i>Acres</i>	<i>Acres</i>
Virginia Piedmont.....	110, 200		135, 400	125, 600	5, 500	376, 700
North Carolina.....	163, 400	74, 000	558, 800	⁴ 74, 000	22, 100	892, 300
South Carolina.....	295, 700	80, 300	344, 700	38, 000	12, 700	771, 400
Georgia.....	728, 200	693, 600	293, 000	81, 900	13, 700	1, 810, 400
Florida.....	181, 100	2, 950, 600	60, 200	94, 700	26, 500	3, 313, 100
Alabama.....	677, 200	276, 900	542, 600	212, 000	11, 400	1, 720, 100
Mississippi.....	1, 059, 600	504, 100	234, 300	164, 400	11, 400	1, 973, 800
Louisiana.....	107, 600	716, 300	156, 300	39, 800	54, 600	1, 074, 600
East Texas.....	197, 000	138, 300	164, 400	63, 500	10, 200	573, 400
Arkansas ⁵	204, 400		86, 300	69, 900	49, 100	409, 700
Southeast Oklahoma.....	45, 600		40, 700	59, 000	2, 000	147, 300
Total.....	3, 770, 000	5, 434, 100	2, 616, 700	1, 022, 800	219, 200	13, 062, 800
Total.....	<i>Percent</i> 28. 9	<i>Percent</i> 41. 6	<i>Percent</i> 20. 0	<i>Percent</i> 7. 8	<i>Percent</i> 1. 7	<i>Percent</i> 100. 0

¹The estimates are conservative, but are comparable between States. They were derived before wartime over-use had increased the area in need of planting. They include only land considered silviculturally and economically desirable to plant. They omit the outlying portions of the southern pine region and areas likely to be needed for higher agricultural use. Source: Southern and Appalachian Forest Surveys, Forest Service, U. S. Dept. Agr., 1933 to 1940, inclusive. More recent estimates for parts of the South are available (445, 446, 447, 448, 610).

²Exclusive of that in the Delta portions of Mississippi, Louisiana, and Arkansas.

³Including those with hardwoods in mixture.

⁴Exclusive of the Mountain Unit of the Survey in North Carolina.

⁵Except the northwest part, not covered during 1933 to 1940.

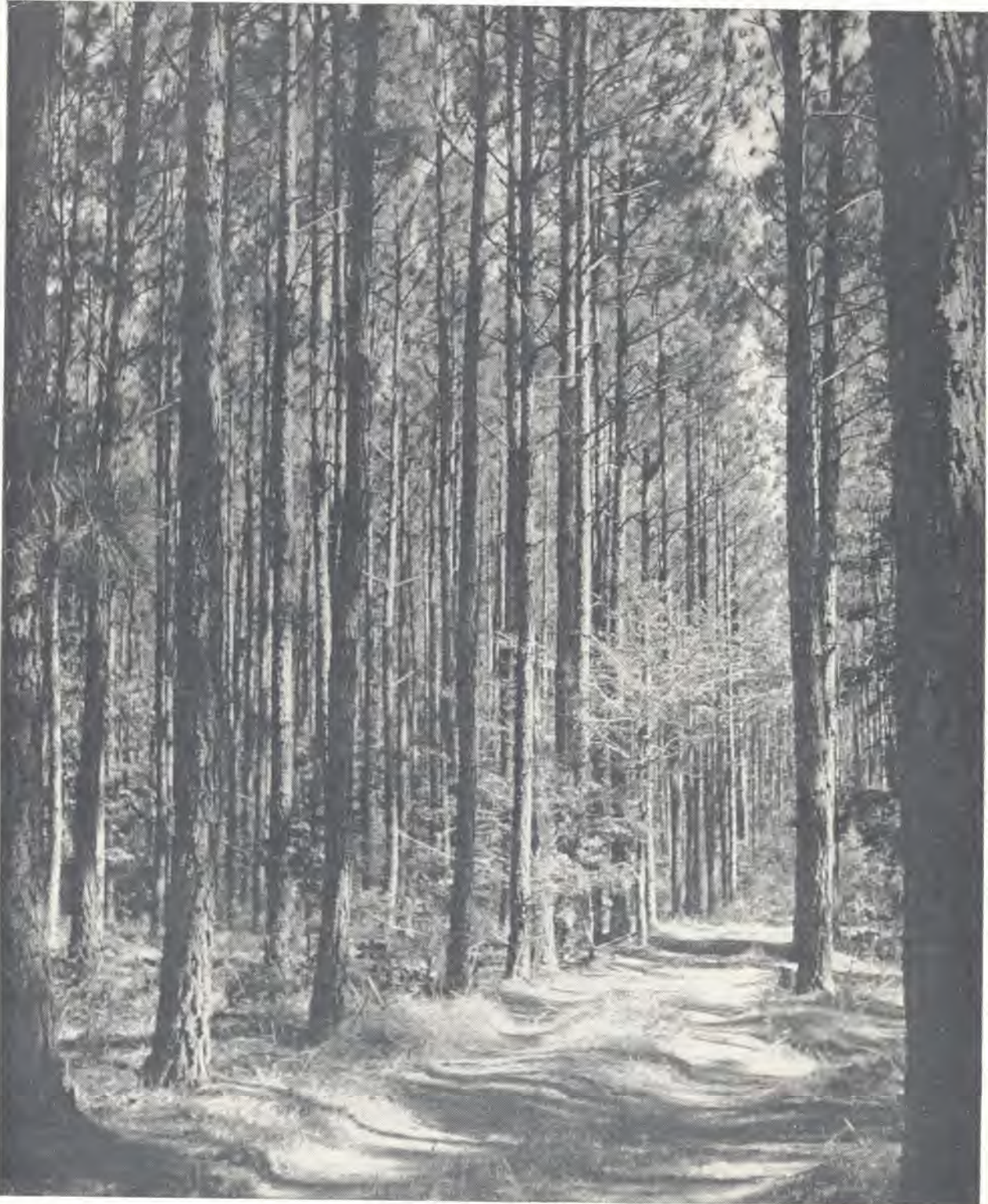

F-465213

FIGURE 1.—Part of an 853-acre slash pine plantation at Bogalusa, La., photographed 24 years after its establishment in 1924-25.

This monograph summarizes the technical knowledge that is now available. The information has been drawn from many sources, but the bulk is from studies conducted by the Southern Forest Experiment Station since 1922 and from records of Region 8, U. S. Forest Service. A number of the research findings from these studies are being published for the first time. Most of the studies and observations cited from other sources have not previously been evaluated in one publication.

The successive steps in planting are taken up in the order in which they are usually carried out.

The first chapter discusses the bases for policy decisions, most of which must be made before a planting job is started. The second chapter deals with seed. The third concerns nursery practice. The fourth relates to field planting, and the last discusses the protection and early care of plantations.

Although pine planting in the South will not be entirely restricted to the principal southern species, they will receive the main emphasis for some years to come. For this reason, the monograph is limited to loblolly, slash, longleaf, and shortleaf pines. Several minor species of southern pines are mentioned only incidentally.

PLANTING POLICIES

The success of any planting program depends upon fundamental decisions of policy that must be made before a pound of seed can be bought or a square foot of soil turned. The discussion in the sections immediately following is intended as a guide to such matters as the selection of species, choice of spacing, means of procuring suitable planting stock, and determination of plantable land. Costs of planting and plantation yields are briefly discussed, as well as the urgent need for maintaining records and observing safety practices.

SPECIES CHARACTERISTICS THAT AFFECT PLANTING

A choice between species must be made in most planting programs, since two or more species may be suitable on two-thirds of the plantable acreage. The essential thing is to choose a species well adapted to the local climate and sites and the local pattern of fire, insects, diseases, and other hazards. Such adaptation is far more important than hypothetical differences in average rate of growth, strength of wood, and the like. The one clear exception to this rule is in plantations established for gum naval stores, for which either longleaf or slash pine must be used.

Loblolly Pine

Among the four principal southern gines, the range of loblolly (*Pinus taeda* L.) is second only to that of shortleaf in extent. It includes the Coastal Plain from New Jersey to Florida and Texas, and the Piedmont, and it runs north in the Mississippi Valley to Tennessee, Arkansas, and Oklahoma.

The advantages of loblolly pine for planting include, in addition to its wide range and usually high yields, the ease with which its seed can be extracted, cleaned, and stored; the ease of management in the nursery; its good initial height growth after planting; its relative resistance to brown-spot needle disease (caused by *Scirrhia acicola* [Dearn.] Siggers) and infrequent injury by hogs; its adaptability to a great variety of sites (including many types of eroding sites); its superiority to shortleaf pine in controlling erosion by heavy needle-fall; its relative resistance to injury by glaze and snow (34, 458, 534, 538); and the likelihood of aggressive natural reproduction in subsequent rotations.

However, loblolly pine also has some disadvantages. It is not as abundant or regular a seed producer in the inland portions of its range as was formerly supposed (297, 756). Its cones are difficult to detach from the trees and expensive to collect. Its seed is subject to dormancy and frequently requires special treatment to stimulate germination.

Loblolly pine is highly susceptible to the southern fusiform rust (caused by *Cronartium fusiforme* Hedgc. and Hunt). The rust cankers cause some mortality and appreciable loss of production from defect, even though loblolly is less easily killed than slash pine by this disease (394). After shortleaf pine, loblolly is the species most seriously affected by littleleaf disease (324). It is extensively bitten back by rabbits immediately after planting and attacked seriously by Nantucket tip moth (*Rhyacionia frustrana* Comst.). It is the most susceptible of the four principal southern gines to injury by fire. Planted loblolly pine is likely to be rougher and limber than planted slash pine.

Despite its good survival and growth on a great variety of soils, loblolly pine seems less well adapted than shortleaf to the drier sites in the northern and western parts of its range. It is inferior to slash pine on poorly drained sites in the southern part of its range, and to longleaf on deep, dry, sterile sands. In many parts of Mississippi, Louisiana, and Texas it is also less well adapted than either longleaf or slash pine to large areas of former longleaf pine sites having sandy or fine sandy loam surface soils underlain at shallow depths by stiff subsoils.

Slash Pine

The natural range of slash pine (*Pinus elliottii* Engelm.) in the United States is limited to the Coastal Plain from southern South Carolina to Florida and west nearly to the Mississippi River.

Planting has extended the range to parts of North Carolina, northern Alabama and Mississippi, western Louisiana, southern Arkansas, and eastern Texas. Early apprehensions about the ability of slash pine to produce viable seed and to reproduce itself naturally in these localities seem to have been unfounded (48, 607, 773). Nevertheless, widespread glaze or ice damage, and certain deficiencies in form and growth rate (173), cast some doubts on the soundness of wholesale planting of slash pine (especially for saw timber)

beyond its native range, even in western Louisiana and eastern Texas. A final opinion on this point must await further observation and research.

Within and near its natural range, slash pine is a relatively good seed producer. Its seed is easy to collect, extract, clean, and store, and seldom becomes strongly dormant. The species is easy to manage in the nursery. Although it is a moist-site species, it is adaptable to almost all but the very dry sites. Planted seedlings make rapid initial growth, are highly resistant to tip moth, and soon attain fairly high resistance to fire (660, 689). Planted slash pine prunes itself better than planted loblolly (538). Littleleaf disease has not yet been reported on slash pine, though perhaps only because few or no slash plantations have reached susceptible ages in the littleleaf territory. On favorable sites, slash pine has excellent possibilities of aggressive natural reproduction in subsequent rotations. The vigor and uniformity of its early growth, and its value for naval stores, have made it the favorite species for planting in the lower South.

Despite slash pine's excellent showing in young stands and the wide and favorable publicity it has received, it still offers some problems. In many nurseries it is subject to heavy infection by southern fusiform rust. In some nurseries and on adverse planting sites it is rather susceptible to brown spot. It is extensively nipped by rabbits; injury by leaf-cutting ants is more often fatal to newly planted slash pine than to newly planted longleaf seedlings; and slash pine plantations up to at least 5 years old may be seriously damaged by hog-rooting (333). Southern fusiform rust infects slash pine in plantations at least as heavily as it does loblolly, with much higher mortality among infected trees (394). Ice storms ("glaze" or sleet), with or without snow, injure slash pine much more seriously than any of the other three principal southern pines (34, 458, 534, 538). Under comparable conditions, slash is the least windfirm of the southern pines (177).

Slash pine undoubtedly owes part of its popularity to its almost universally clean, vigorous appearance the first few years after it has been planted. In its proper place, slash pine is indeed an ideal tree to plant. But in zones of extreme rust infection or severe ice storms, or on the drier, less fertile longleaf pine sites, or far beyond its natural range, it has by no means always fulfilled the promise of its good initial growth.

Longleaf Pine

Longleaf pine (*Pinus palustris* Mili.) occurs in the Coastal Plain from Virginia to southern Florida and west to eastern Texas, with extensions into northwestern Georgia and central and northern Alabama.

Planting the Southern Pines

The three chief advantages of longleaf pine for planting are its acceptable rate of growth on large acreages where other species grow poorly or not at all, its infrequent infection by southern fusiform rust (654, 655, 658, 665), and especially its remarkable resistance to fire (746). Its apparently high resistance to littleleaf disease (324) may also prove to be a great advantage.

Longleaf seedlings, especially in the "grass" stage, frequently sprout and recover after various types of injury. Longleaf pine is virtually untouched by rabbits and tip moth and is seldom injured much by glaze and snow (158; 534; 746, p. 186). Contrary to impressions given in the literature, it has usually been easy to get enough longleaf pine seed. Longleaf is less subject than any other southern pine to stagnation of growth through overcrowding.

Despite these merits, longleaf is in many ways more difficult to plant than the other southern pines.

Longleaf pine cones are heavy and bulky to collect and ship. Incorrect cone storage and too high a degree of heat in extracting kilns can easily injure the seed, which also is difficult to clean and exacting as to storage requirements. Nursery spraying to control brown spot is almost always essential. The greater size and weight of longleaf seedlings makes them about half again more expensive to ship than slash or loblolly pine seedlings.

First-year survival is often more difficult to attain with longleaf pine than with other species (765, 766). The seedlings usually remain "in the grass" for 3 to 5 years, and, where brown spot is severe and prescribed burning (p. 162) is neglected, frequently for 10 years and sometimes for 20 or more (746, 759). This habit places longleaf at a disadvantage in comparison with other southern pines (fig. 2). It also handicaps longleaf in competition with hardwood sprouts and brush (690) and even with grass and weeds, and keeps the seedlings for long periods in a stage susceptible to brown spot and hogs. Where height growth is unduly delayed, mortality is likely to continue annually for many years (fig. 2, B). In contrast, plantations of other species ordinarily suffer little mortality between first-year establishment and the closing of the crowns, unless from unusual epidemics or from fire.

It is essential to fence young longleaf pine plantations against hogs to prevent serious loss, and against sheep and goats to prevent their deforming the trees by biting out the buds. The cost of controlling pocket gophers (*Geomys* spp.) and leaf-cutting ants (*Atta texana* Buckley) is most likely to occur in longleaf plantations, because these pests prefer longleaf sites.

The establishment of the next rotation by natural reproduction is more difficult and less certain with longleaf than with any of the three other principal southern pines.



F-465214, 465215

FIGURE 2.—Comparably spaced longleaf (left) and slash pines: *A*, 14½ years after planting at Auburn, Ala.; and *B*, 20 years after planting at Bogalusa, La. *A* shows a common and *B* an extreme contrast in survival, growth, and crown canopy of the two species.

While they must be recognized, these difficulties should not be overstressed. Longleaf pine is capable of high survival and good early growth (fig. 3). It survives and grows better than other species on certain sites, and at least as well as other species on many more. About 40 percent of the plantable acreage in the South lies in the longleaf pine types (table 1), where climate and the grasses and brush naturally associated with longleaf combine to make fires start easily and spread fast. On these sites planting loblolly or slash pine does not decrease the flammability of grass and brush (166) and the risk remains too great for these pines. The high resistance of longleaf pine to fire, combined with its good qualities as timber, its value for naval stores, and its low susceptibility to fusiform rust and to climatic injury, more than offsets its less desirable characteristics. Postwar planting programs show an encouraging tendency toward increased use of longleaf pine.

Shortleaf Pine

Shortleaf pine (*Pinus echinata* Mill.) has the widest natural range of the four principal southern pines. Its northern range extends from extreme southeastern New York State and eastern and southern Pennsylvania through West Vir-

southern Ohio, Kentucky, southern Illinois, Missouri, and Oklahoma. It extends south to northern Florida and eastern Texas.

Shortleaf pine is adapted to a great variety of sites, including some of the more sterile or eroded soils in dry localities (188, 508, 511), and at the higher elevations. The seed is easily extracted, dewinged, cleaned, and stored. Hogs seldom injure the seedlings. Although its initial growth is less aggressive than that of loblolly, shortleaf pine sprouts when it is killed back by fire during the first 3 or 4 years of growth (521, 546); this gives it an advantage over loblolly where fire protection is poor. Of the four principal southern pines it suffers the least ice damage (34, 512). In the northern part of its range, at least, it withstands prescribed burning after reaching 2 inches in diameter at breast height (430).

Throughout its main range, shortleaf pine has good possibilities of fairly aggressive natural reproduction in succeeding rotations. It is particularly valuable for planting on abandoned agricultural land in the unglaciated portions of the Central States, because it survives where planted hardwoods do not and because the low density of its crowns permits desirable hardwoods to come in sooner under it than under many other conifers (59, 158).



F-275948, 465216

FIGURE 3.—Survival and growth of longleaf pine under near-optimum conditions. H. C. Thompson plantation, St. Tammany Parish, La., photographed from same point 5 and 18 years after establishment.

Production of shortleaf pine seed, like that of loblolly, is frequently poor over large parts of the species' range (297, 802), especially in the mountains. The cones are small, difficult to detach, and expensive to collect. In the southern part of the shortleaf range, high summer temperatures appear to hinder the normal growth of nursery stock. Rabbit injury during the first year after planting may be severe. Nantucket tip moth damages shortleaf pine as badly as it does loblolly pine but shortleaf does not recover so readily as the latter species. Shortleaf pine is rarely affected by southern fusiform rust, but in many places is heavily infected by a closely related fungus, *Cronartium cerebrum* Hedgc. and Long (394). Although shortleaf seedlings sprout after burning, small ones are more easily killed back by fire than are young slash and especially longleaf.

The most serious handicap from which shortleaf pine suffers is its extreme susceptibility to littleleaf disease (324). This disease may make shortleaf useless for planting throughout the Pied-

mont and some adjacent territory. Until more is learned about the disease it seems poor policy to plant shortleaf pine in pure stands anywhere within the range of loblolly pine.

CHOICE OF SPECIES TO PLANT

Climate and other conditions within the southern pine region vary fully as much as the characteristics of the different species.

Mean annual temperatures within the southern pine region, for example, vary from 55° to 75° F. Minimum temperatures vary even more widely, and average frost-free periods range from 200 days or less (Missouri, northern Mississippi, Maryland) to more than 320 days per year (Florida) (733).

In a large area in northern Florida, southern Georgia, and southeastern Alabama, rainfall between November 1 and April 30 averages about 7 to 11 inches less than it does in Louisiana, Mississippi, and central Alabama (fig. 4) (764).



F-275948, 465216

FIGURE 3.—Survival and growth of longleaf pine under near-optimum conditions. H. C. Thompson plantation, St. Tammany Parish, La., photographed from same point 5 and 18 years after establishment.

Production of shortleaf pine seed, like that of loblolly, is frequently poor over large parts of the species' range (297, 802), especially in the mountains. The cones are small, difficult to detach, and expensive to collect. In the southern part of the shortleaf range, high summer temperatures appear to hinder the normal growth of nursery stock. Rabbit injury during the first year after planting may be severe. Nantucket tip moth damages shortleaf pine as badly as it does loblolly pine but shortleaf does not recover so readily as the latter species. Shortleaf pine is rarely affected by southern fusiform rust, but in many places is heavily infected by a closely related fungus, *Cronartium cerebrum* Hedgc. and Long (394). Although shortleaf seedlings sprout after burning, small ones are more easily killed back by fire than are young slash and especially longleaf.

The most serious handicap from which shortleaf pine suffers is its extreme susceptibility to littleleaf disease (324). This disease may make shortleaf useless for planting throughout the Pied-

mont and some adjacent territory. Until more is learned about the disease it seems poor policy to plant shortleaf pine in pure stands anywhere within the range of loblolly pine.

CHOICE OF SPECIES TO PLANT

Climate and other conditions within the southern pine region vary fully as much as the characteristics of the different species.

Mean annual temperatures within the southern pine region, for example, vary from 55° to 75° F. Minimum temperatures vary even more widely, and average frost-free periods range from 200 days or less (Missouri, northern Mississippi, Maryland) to more than 320 days per year (Florida) (733).

In a large area in northern Florida, southern Georgia, and southeastern Alabama, rainfall between November 1 and April 30 averages about 7 to 11 inches less than it does in Louisiana, Mississippi, and central Alabama (fig. 4) (764).

Planting the species that formerly grew on the site, although often advisable, is by no means always profitable or safe. The development of littleleaf disease since 1935, for example, has made questionable the planting of shortleaf pine on some former shortleaf sites in the Piedmont. In the mixed pine-hardwood and upland hardwood types, cultivation and erosion have frequently so modified the sites that only the pines can be planted successfully on lands where hardwoods formerly grew (59). The rule also breaks down where, as in the case of slash pine, a species is extended somewhat beyond its native range.

A safer rule than planting the species which originally occupied the site is to plant the species showing the best performance in nearby plantations—especially the older plantations—or in natural stands on comparable sites. If plantations are too few or too young to guide the planter in

choosing species, his next best solution is to study the soil, the moisture conditions, the hazards, and the plant cover of his different sites, and to choose the species found most suitable under similar conditions elsewhere (table 2 and fig. 5).

The southern pines have been planted almost entirely in pure stands, and on some hundreds of thousands of acres single-species plantations hold much promise. Other thousands of acres, however, promise only moderate success at best, or have already failed because the wrong species was chosen.

⁴ Table 2 gives only rather generally proved or accepted recommendations of species for sites, by broad regions. The literature contains the results of many other studies of species for sites, of high potential value to planters in the localities involved (102, 128, 150, 157, 158, 162, 163, 180, 181, 182, 183, 184, 188, 210, 349, 309, 415, 419, 421, 408, 505, 506, 508, 510, 511, 577, 583, 625, 629, 705, 727, 728, 729).

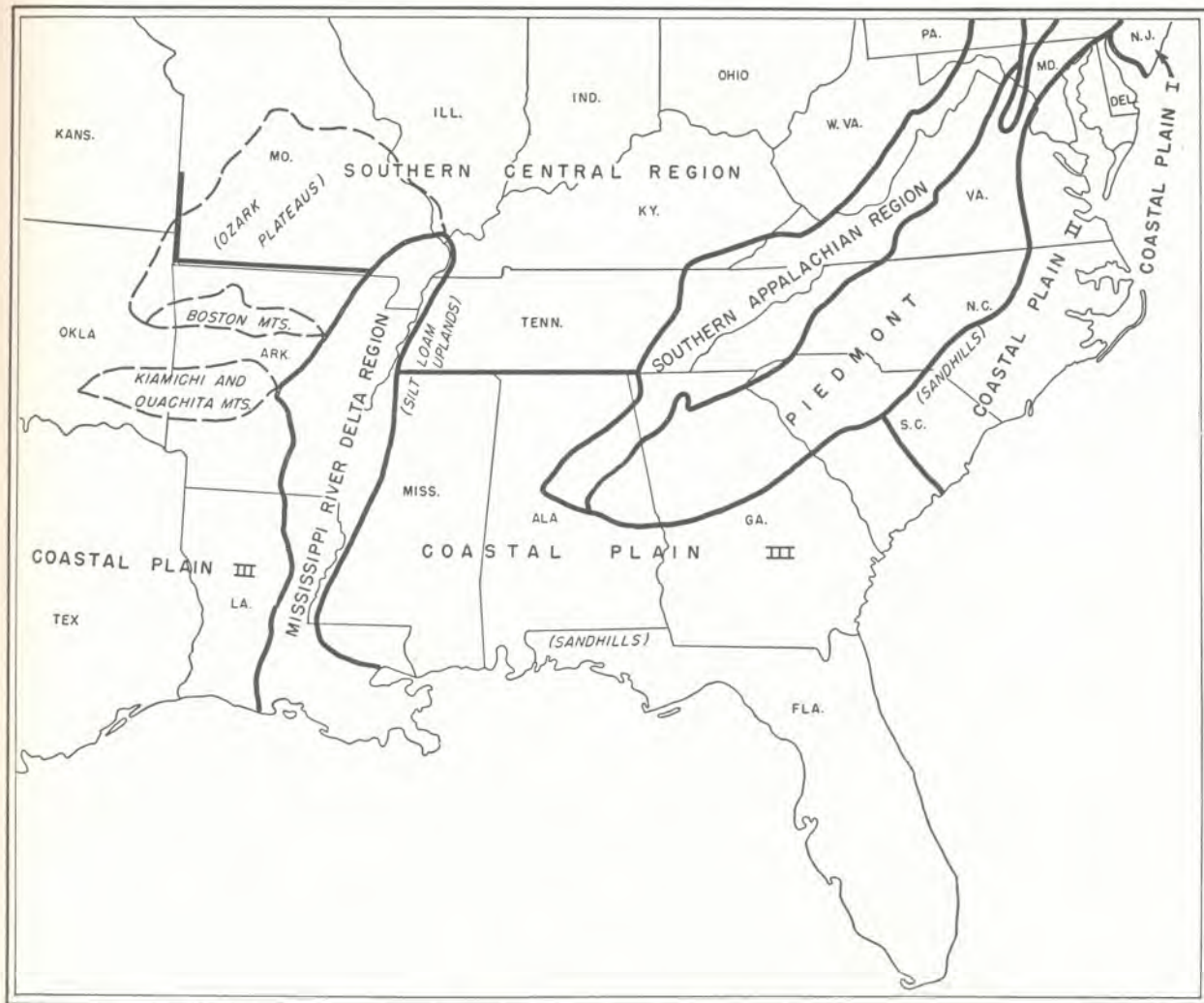

FIGURE 5.—Regions distinguished in suggesting southern pines for planting on various sites (table 2), as adapted from Fernemau (250), Minckler and Chapman (513), and unpublished data.

Table 2.—Southern pines suggested for planting on sites within various regions in southeastern United States

Region and subregion (forest type formerly occupying site, or occupying similar site nearby)	Species of pine to plant ¹	Sites ² which may be planted with reasonable chance of success	Sites ² which should be planted only on experimental scale until success has been demonstrated
Coastal Plain Region I, southern New Jersey. (Shortleaf pine; shortleaf pine-hardwoods.)	Shortleaf ³ -----	Well-drained, including dry sands.	Wet, poorly drained sites.
Coastal Plain Region II: Maryland, Virginia, and northern North Carolina. (Any pine or pine-hardwood type except longleaf pine on deep sandhills or pond pine ⁴ on wet sites.)	Loblolly-----	Almost any well-drained or fairly well-drained soil. ⁵	Wet, poorly drained sites or excessively deep, dry sands.
Southern North Carolina and northern South Carolina. (Any pine or pine-hardwood type except longleaf pine on deep sandhills or pond pine ⁴ on wet sites.)	do-----	do-----	Do.
North and South Carolina sandhills bordering Piedmont. (Longleaf pine.)	Loblolly-slash mixtures.	Moister sites only-----	Drier sites in general, or where ice storms are frequent or southern fusiform-rust infection is extreme.
Coastal Plain Region III: South Carolina to Florida and west into Arkansas and Texas. (All loblolly, shortleaf, and upland hardwood types, pure or in combination.)	Loblolly-----	Almost any well-drained, fairly deep soil, including many eroded and severely eroded soils.	Wet, poorly drained sites, extremely dry sites, or those with stiff clay subsoil less than 8 to 10 inches below surface.
	Loblolly-slash mixtures.	Moister but still well-drained sites, especially in southern and eastern extensions of types mentioned.	Drier sites, sandiest hills, or where ice storms are frequent or southern fusiform-rust infection is extreme.
	Slash-----	Moister sites, especially east of Mississippi River. Likely to do better than loblolly on poorly drained, wet sites and on sites with stiff subsoils within 8 to 10 inches of surface.	Dry sites or sandiest hills, especially in northern extensions of types or west of Mississippi River, or in localities of frequent ice storms or extreme fusiform-rust infection.
	Shortleaf-----	Some eroded and other drier sites in northern extensions of types and at higher elevations on former shortleaf, shortleaf-hardwood, or upland hardwood lands.	In southern extensions of types mentioned, or where littleleaf disease is prevalent.
(Longleaf-slash or pure longleaf types.)	Slash-----	On moderately moist to wet sites in former longleaf-slash types, including pure longleaf type in central and southwestern Louisiana.	On deep, sterile sands (especially western Florida sandhills), or on dry ridges north or west of native range of slash pine, or where ice storms are frequent or southern fusiform-rust infection is extreme.
	Longleaf-slash mixtures.	On moderately moist to moderately dry sites throughout former longleaf-slash and longleaf types.	On extremely wet or extremely dry sites, or where southern fusiform-rust infection is extreme.
	Loblolly, or longleaf-loblolly mixtures.	On moderately moist but well-drained sites without stiff subsoil or with stiff subsoil at least 10 to 12 inches below surface. Preferable to slash or slash mixtures where ice storms are frequent or southern fusiform-rust infection is extreme.	On extremely wet or dry sites or those with stiff subsoil near the surface. (Mixtures containing longleaf or slash may be preferable to pure loblolly where littleleaf disease is prevalent, but longleaf should not be mixed with loblolly in areas of more than very light brown-spot infection.)

See footnotes at end of table.

TABLE 2.—Southern pines suggested for planting on sites within various regions in southeastern United States—Continued

Region and subregion (forest type formerly occupying site, or occupying similar site nearby)	Species of pine to plant ¹	Sites ² which may be planted with reasonable chance of success	Sites ² which should be planted only on experimental scale until success has been demonstrated
Coastal Plain Region III—Con. South Carolina to Florida and west into Arkansas and Texas—Continued (Longleaf-slash or pure longleaf types)—Con.	Loblolly-slash mixtures.	On moderately moist sites on which stiff subsoil lies within 10 inches of surface in some places, or where littleleaf disease is prevalent.	On extremely wet or dry sites, or where ice storms are frequent or southern fusiform-rust infection is extreme.
	Longleaf-----	On moderately moist to driest sites formerly in longleaf pine. Has better chance than loblolly where stiff subsoils are near surface, or on deep, dry sands, and better than slash on deep, dry sands or where southern fusiform-rust infection is extreme.	On very wet sites.
Southeastern Oklahoma----- (Shortleaf, shortleaf-hardwood, and upland hardwood types.)	Shortleaf-----	Practically all sites-----	
Kiamichi and Ouachita Mountains; Boston Mountains; Ozark Plateau of Arkansas; Oklahoma and Arkansas----- (Shortleaf, or shortleaf-hardwood, and upland hardwood types.)	do-----	do-----	
Piedmont: South through Virginia ⁶ ----- (Shortleaf, shortleaf-hardwood, and upland hardwood types.)	do-----	do-----	Very wet sites, or where littleleaf disease prevails. (Minckler and Chapman recommend substituting Virginia pine on areas eroded to the subsoil.)
North and South Carolina ⁶ ----- (Pine, pine-hardwoods, and upland hardwood types.)	Loblolly-----	All moister, deeper soils, especially in more southerly locations and at lower elevations.	On poorly drained spots or driest sites or at highest elevations, especially in most northerly locations; on sites eroded to the subsoil.
	Shortleaf-----	On driest sites and at highest elevations and most northerly locations.	On poorly drained spots, or where littleleaf disease is prevalent.
Georgia and Alabama----- (Pine, pine-hardwood, and upland hardwood types.)	Loblolly-----	A great variety of sites, including many eroding and severely eroding ones.	On very wet sites, on very dry sites at highest elevations, and perhaps where littleleaf disease is severe.
	Loblolly-slash mixtures.	Moister sites, especially near the Coastal Plain; perhaps preferable to pure loblolly where littleleaf disease is severe.	Where ice storms are frequent, or on dry sites, especially far north or at high elevations.
	Slash-----	On fairly moist to wet sites, especially near Coastal Plain or where littleleaf disease is severe.	Where ice storms are frequent or southern fusiform-rust infection is extreme, or on dry sites, especially far north or at high elevations.
	Shortleaf-----	Driest sites, at highest elevations and farthest north.	On very wet sites, in southerly locations, or where littleleaf disease is prevalent.
Southern Appalachian Region: General, including southeastern Tennessee, but excepting Alabama. ⁶ (Hardwood and pine-hardwood types.)	do-----	Slope and ridge soils-----	Where littleleaf disease is prevalent. (Minckler and Chapman recommend substituting Virginia pine above 2,500 feet, and eastern redcedar on pure limestone areas.)

See footnotes at end of table.

TABLE 2.—*Southern pines suggested for planting on sites within various regions in southeastern United States—Continued*

Region and subregion (forest type formerly occupying site, or occupying similar site nearby)	Species of pine to plant ¹	Sites ² which may be planted with reasonable chance of success	Sites ² which should be planted only on experimental scale until success has been demonstrated
Southern Appalachian Region—Continued			
Southeastern Tennessee only (Hardwood and pine-hardwood types.)	Loblolly-----	Moister, deeper soils. Loblolly may be better than shortleaf on such sites, especially where littleleaf occurs.	Drier sites at higher elevations.
Alabama----- (Any other than longleaf pine types.)	do-----	A great variety of sites, having fairly deep surface soils.	Extremely wet or dry sites or sites at high elevations.
(Longleaf pine types.)	Shortleaf-----	Driest sites and those at highest elevations.	Where littleleaf disease is prevalent.
	Loblolly, or longleaf-loblolly mixtures.	Best and deepest soils, with stiff subsoil at least 10 to 12 inches or underlying rock at least 24 to 30 inches below surface. Mixture preferable where littleleaf disease is prevalent.	Very wet or dry sites. On sites containing appreciable areas of shallow surface soil, longleaf-loblolly mixtures may be preferable to pure loblolly.
	Longleaf-----	A great variety of sites, especially those with stiff subsoils only a short distance beneath the surface.	Very wet sites.
Southern Central Region: General, except western Tennessee. ^b (Shortleaf, shortleaf-hardwood, and upland hardwood types.)	Shortleaf-----	Practically all slope and ridge soils, including severely eroded soils. (Most planting of southern pine in this region is on abandoned fields.)	On wet upland flats.
Western Tennessee----- (Pine, pine-hardwood, and upland hardwood types.)	Loblolly-----	Moister, deeper soils; many of more fertile though badly eroded soils in silt-loam uplands.	Driest sites; severely eroded areas east of silt-loam uplands.
	Shortleaf, or loblolly-shortleaf mixtures.	Drier sites, and badly eroded sites east of silt-loam uplands.	Very wet sites.

¹ Where mixed planting is suggested, mixtures of 3 rows or 5 rows, or in checkerboards of 9- or 25-tree squares, ordinarily are preferable, regardless of species. Longleaf pine in particular should never be planted in single-row or individual-tree mixture with other species.

² None of the principal southern pines may be expected to do well on very brushy sites unless the sites are specially prepared before planting or the planted trees are later released from competition; see pp. 123 and 141.

³ A conference of forestry agencies in New Jersey recommends loblolly as well as shortleaf pine for all but the driest sands, and for some sites too poorly drained for shortleaf (409).

⁴ Information (583) on planting the pond pine type is too limited for general recommendation.

⁵ But on former longleaf sites on which a stiff subsoil lies 8 inches or less below the surface, longleaf may do better than loblolly.

⁶ Adapted from Mineckler and Chapman (513).

Millions of acres yet to be planted lie within the ranges of at least two southern pines, and in localities where both species have reasonably good chances of thriving but where either may be injured, at a time and to a degree impossible to predict, by some influence or pest affecting one species more seriously than the other. Under such circumstances, and especially where sites vary greatly within short distances, planting two species in mixture deserves consideration.

Growing species in mixed instead of in pure stands is widely recognized as a generally sound silvicultural principle, especially in connection with the control of insects and disease (4, 100, 109, 217, 299, 302, 316, 340, 409, 603, 616, 630, 681, 696). Planting southern pines in mixtures may serve any or all of the four following specific purposes:

1. In localities where little planting has been done and where there are sites for which the best

⁷ Planting two species in mixture, as used here, means the inclusion of both species, usually in strips (groups of rows), uniformly over the planting site. Fitting individual species to different sites one-fourth or one-half acre up to several hundred acres in extent (472), while it attains some of the objects of mixed planting, is merely an intensification of choice of species for site. It is not mixture in the present sense.

species is not yet certainly known, mixed planting tests the comparative survival, thriftiness, growth, and yields of the two or more species over a considerable percentage of the sites to be planted in the future. Such localities are still numerous in the southern pine region.

2. Regardless of which of two species is better adapted to any particular spot in the planting area, planting the two in mixture insures a seed source of the ultimately preferable species for the natural regeneration of that spot in the next rotation.

3. Unless both species make exactly equal height growth, the mixture to some extent insures the planted stand against stagnation if the first thinning must be postponed.

4. If judiciously chosen, the mixture helps insure the stand against serious depletion or outright destruction, especially by a single injurious influence.

Mixtures of slash and loblolly pines and of loblolly and shortleaf pines have proved promising in several widely separated parts of the southern pine region (283, 538, 690). In the plantation described by Muntz (538), loblolly, although inferior to slash pine in forro, excelled it in growth rate except in a part of the plantation accidentally burned at an early age; in the burned part, the greater fire resistance of the intermingled slash pine appreciably reduced the damage to the burned stand. An adverse effect of mixing slash with loblolly pine has, however, been reported from the zone of frequent, severe ice damage near State College, Miss. Here the presence of slash pine in a mixed plantation greatly increased the ice damage to loblolly, as compared to that suffered by loblolly in pure stands (34).

Specialists disagree about the desirability of planting longleaf pine in mixture. Some regard early prescribed burning, especially for brown-spot control (p. 162), as essential to successful planting of longleaf, and consider such prescribed burning of slash-longleaf mixtures impossible on a large scale without too great rust infection (p. 161) or outright killing of the slash pine. They argue that much of the longleaf type is too far outside the natural range of slash pine to permit safe planting of slash; that many longleaf sites within the range of slash pine are not suited to slash; that in alternate-row mixtures slash will suppress longleaf; and that even in three-row or five-row mixtures with longleaf, the slash will develop so many limby trees in the border rows as to be unprofitable. They advocate very intensive assignment of slash and longleaf to different sites within the same small area, but not mixture on the same site.

Much of the foregoing is conceded, particularly that there are some sites on which only longleaf pine and others on which only slash pine should be planted, and that longleaf should be planted in

mixture with other species only in alternate strips at least 3 and not more than 10 rows wide.*

For the reasons given below, however, slash-longleaf mixtures may be highly advantageous in many localities within and close to the natural range of slash pine, and particularly outside the zones of worst chronic brown-spot and southern fusiform-rust infection (fig. 4) but where the rust is still a serious threat to slash pine.

Longleaf pine is resistant or practically immune to the ills that affect slash pine, and slash to those that affect longleaf. In the localities described above, uncontrolled fires, hog damage, rabbit damage, brown spot, southern fusiform rust, and perhaps ice storms may affect part or all of any plantation. Neither the locality, nor the severity, nor the year in which the injury may occur, can be predicted; hence it is hard to justify much expenditure for protection other than the usual fire-control system and fences. At the same time, either longleaf or mixed longleaf-slash plantations in these localities, if they require prescribed burning at all, are less likely to require it early than are plantations in the worst brown-spot zones—and slash pine soon develops enough fire resistance to stand prescribed burning (407, 660, 689). Under the circumstances, a mixture of longleaf and slash pines seems cheap enough insurance to deserve a more thorough trial than it has received.

The results of experimental mixtures of slash and longleaf pines on the J. K. Johnson Tract (Louisiana) and the Harrison Experimental Forest (Mississippi) support this view. In these experiments, longleaf and slash planted in equal mixture were protected against hogs but burned severely (to simulate accidental or incendiary fires) in either the first, second, third, or fourth winter after planting, or were kept unburned but were exposed to hogs. The results showed that under like treatments, pure slash pine plantations would have been destroyed by fire in any of the first three winters, and pure longleaf by hogs in any of the 4 years. In the experimental mixtures tested, neither unrestricted hogs nor fire in any of the four winters killed enough of the mixed stand to leave the site seriously understocked.

It is recommended, therefore, that southern pine be planted in pure stands wherever species characteristics and local hazards and sites make one species indubitably superior to any other. Where circumstances make local hazards highly unpredictable, and especially if there is also much ques-

* It has been suggested that a checkerboard pattern of 2 species, in squares of 25 trees each, makes a better mixture. But if planted by hand, this mixture decreases labor efficiency about 20 percent (599), and it is almost impossible to plant by machine. Mixing two species in alternate strips costs little if any more than planting in pure stands.

† The experimental planting areas are described on pp. 198-201.

tion as to which of two species is better adapted to many different local sites, it is recommended that the two species that seem most suitable be planted in mixture, preferably in strips at least 3 but not more than 10 rows wide.

GEOGRAPHIC SOURCE OF SEED

Choosing seed from the wrong geographic source, even though it is of the right species for the planting site, may result in plantation failure (92, 530, 616). Correct choice of seed source may therefore affect yields and profits more than choice of species for site. It is much more important than optimum spacing, high initial survival, or intensive early care of the plantation. Spacing, survival, and care affect the yield of the original plantation only, but source of seed affects the health and productivity both of the plantations and of all succeeding generations reproduced naturally from the planted trees (735).

This importance of geographic source of seed results from the occurrence, within an individual tree species, of distinct *geographic races* associated with definite climatic zones or other geographical units. Such races are particularly likely to exist in a species having a wide geographical range. The extensive literature on this subject has been summarized and cited in several readily available publications (71, 635, 754). Distinct geographic races exist within several American species. The economic importance of geographic races has been recognized for about 75 years (72), and has been demonstrated in such important species as Douglas-fir, ponderosa pine, and red pine (530, 531, 620, 621, 774).

An experimental plantation established at Bogalusa, La.,⁸ in 1926-27 has shown that distinct and economically important geographic races exist even within the southern half of the range of loblolly pine (754). These races showed important differences (significant or very significant except in survival) in tree size, volume of wood produced, and susceptibility to fusiform rust (fig. 6, table 3). Stock from seed collected within 50 miles of the planting site produced 1.8 to 2.7 times as much merchantable pulpwood in 22 years as did stock from seed collected 350 to 450 miles from the planting site. The potential growth lost by using the Arkansas seed instead of the local Louisiana seed was 1.2 cords per acre per year.

The much heavier fusiform-rust infection of the Georgia than of the Louisiana, Texas, and Arkansas stock is also noteworthy. The difference in degree of infection is associated much more clearly with the longitudes of the seed sources than with their climates. This suggests that there may be different geographic races of the rust fungus in different parts of the loblolly pine range, to which different races of loblolly are not equally resistant. Such races are well known among the closely related cereal rusts (356), and occur also among various fungi causing tree diseases (109). The possibility of such geographic races within the fungus causing fusiform rust is an argument

⁸The planting area is described on pp. 198-200.
⁹Throughout this monograph the terms *very significant*, *significant*, and *not significant* are used in their statistical sense only. They indicate, respectively, odds of less than 1 in 100, less than 1 in 20, and more than 1 in 20 that the differences described are attributable to chance rather than to the experimental treatment—in the present example, the geographic source of seed.

TABLE 3.—Growth and development of loblolly pine, by geographic sources of seed, 15 and 22 years after planting at Bogalusa, ¹ La.

Years after planting and source of seed	Survival	Average height	Average diameter breast high (4½ feet above ground)	Rough wood per acre (trees 4 inches and up)	Peeled wood per acre (trees 2 inches and up)	Living trees with trunks infected by fusiform rust
	<i>Percent</i>	<i>Feet</i>	<i>Inches</i>	<i>Cords</i>	<i>Cubic feet</i>	<i>Percent</i>
15 years:						
Louisiana ²	85	32	5.0	14.2	1,346	6
Texas ³	87	29	4.2	8.8	849	10
Georgia ⁴	85	26	4.0	6.5	689	32
Arkansas ⁵	89	25	3.8	6.3	614	13
22 years:						
Louisiana ²	82	46	6.7	41.8	3,620	4
Texas ³	83	41	5.2	22.7	1,987	6
Georgia ⁴	77	38	5.2	17.7	1,588	37
Arkansas ⁵	84	36	4.7	15.4	1,412	5

¹ In Washington Parish. Mean annual temperature, 68° F.; mean annual rainfall, 61 inches; average frost-free period, 255 days.

² Livingston Parish, 50 miles west-southwest of the planting site. Mean annual temperature, 68° F.; mean annual rainfall, 60 inches; average frost-free period, 260 days.

³ Montgomery County, 350 miles west of the planting site. Mean annual temperature, 69° F.; mean annual rainfall, 44 inches; average frost-free period, 265 days.

⁴ Clarke County, 450 miles east-northeast of the planting site. Mean annual temperature, 61° F.; mean annual rainfall, 50 inches; average frost-free period, 200 days.

⁵ Howard County or nearby, 350 miles northwest of the planting site. Mean annual temperature, 60° F.; mean annual rainfall, 50 inches; average frost-free period, 220 days.



F-465217, 465218

FIGURE 6.—Effect of geographic source of loblolly pine seed on *A*, height of trees, and *B*, total merchantable pulpwood produced on one-eighth of an acre, 22 years after planting at Bogalusa, La. Seed sources in both pictures, from left to right: Louisiana (local), Texas, Georgia, and Arkansas.

against using seed from distant sources even if such sources resemble the planting site in climate.

Sherry (639) in South Africa has confirmed and amplified the findings at Bogalusa. In four different South African localities, the average heights of loblolly pine at 9 years ranged from 34.8 to 45.5, 25.4 to 40.1, 21.1 to 37.1, and 29.9 to 39.1 feet, respectively. In each of the four localities, the relative height of the planted trees depended upon the geographic source of the seed. Average diameters breast high varied in harmony with average heights. From these results, Sherry deduces the existence of a southern, an intermediate, and a northern race of loblolly pine, occurring in north latitudes approximately 30° to 31°, 32° to 35° and 36° to 38°, respectively. Of these, the southern race is much the best adapted to South African conditions (639).

Local seed may be equally necessary with longleaf and shortleaf pines, whose botanical characteristics differ from one geographic region to another (143, 144). Longleaf has shown distinct differences in root and in foliage development, and shortleaf has shown distinct differences in nursery development and in subsequent growth, all definitely associated with geographic source of seed.

The evident existence of geographic races of American forest trees led the Department of Agriculture, in 1939, to formulate the following policy concerning the use of forest tree seed (439):

Recognizing that trees and shrubs, in common with other food and fiber plants, vary in branch habit, rate of growth, strength and stiffness of wood, resistance to cold, drought, insect attack, and disease, and in other attributes which influence their usefulness and local adaptation for forest, shelterbelt, and erosion-control use, and that such differences are largely of a genetic nature, it shall be the policy of the U. S. Department of Agriculture insofar as practicable to require for all forest, shelterbelt, and erosion-control plantings, stocks propagated from segregated strains or individual clones of proven superiority for the particular locality or objective concerned. Furthermore, since the above attributes are associated in part with the climate and to some extent with other factors of environment of the locality of origin, it shall be the policy of the U. S. Department of Agriculture:

1. To use only seed of known locality of origin and nursery stock grown from such seed.
2. To require from the vendor adequate evidence verifying place and year of origin for all lots of seed or nursery stock purchased, such as bills of lading, receipts for payments to collectors, or other evidence indicating that the seed or stock offered is of the source represented. When purchases are made from farmers or other collectors known to operate only locally, a statement capable of verification will be required as needed for proof of origin.
3. To require an accurate record of the origin of all lots of seed and nursery stock used in forest, shelterbelt, and erosion-control planting, such records to include the following minimum standard requirements to be furnished with each shipment:
 - (1) Lot number.
 - (2) Year of seed crop.
 - (3) Species.
 - (4) Seed origin:
 - State.
 - County.
 - Locality.
 - Range of elevation.
 - (5) Proof of origin.

4. To use local seed from natural stands whenever available unless it has been demonstrated that seed from another specific source produces desirable plants for the locality and uses involved. Local seed means seed from an area subject to similar climatic influences and may usually be considered as that collected within 100 miles of the planting site and differing from it in elevation by less than 1,000 feet.
5. When local seed is not available, to use seed from a region having as nearly as possible the same length of growing season, the same mean temperature of the growing season, the same frequencies of summer droughts, with other similar environment so far as possible, and the same latitude.
6. To continue experimentation with indigenous and exotic species, races, and clones to determine their possible usefulness, and to delimit as early as practicable climatic zones within which seed or planting stock of species and their strains may be safely used for forest, shelterbelt, and erosion control.
7. To urge that States, counties, cities, corporations, other organizations, and individuals producing and planting trees for forest, shelterbelt, and erosion-control purposes, the expense of which is borne wholly or in part by the Federal Government, adhere to the policy herein outlined.

Until additional data make more detailed specifications possible for each of the southern pines, the Forest Tree Seed Policy just quoted should be accepted as a guide¹⁰ by all agencies engaged in artificial reforestation in the southern pine region. The requirement, in section 4, that local seed come from *natural* stands, deserves special emphasis; seed from *planted* stands, unless the planted trees were from local seed, may have all the undesirable characteristics of seed from a great distance (70). The loblolly seed-source study at Bogalusa, already described, has shown that adhering to the 100-mile zone of section 4 of the policy is preferable to accepting the alternative in section 5.

PLANTING VERSUS DIRECT SEEDING

Sowing seed directly on the planting site often seems a tempting alternative to planting seedlings. The principal inducement is the chance of avoiding the difficulties and especially the costs of producing, shipping, and planting nursery stock. Other theoretically attractive features of direct seeding are freedom from complete dependence on nursery capacities and large planting crews; a longer season for field work; a procedure more convenient for and familiar to farmers than is forest planting; and the possibility of more normal root development of the resulting trees (470). From present knowledge, however, direct seeding of

¹⁰The State of Georgia seed law, act of 1941, as amplified and amended by act of 1945, requires that longleaf, slash, loblolly, and shortleaf pine seed sold or transported for delivery within Georgia be labeled essentially in accordance with sec. 3 of the U. S. Department of Agriculture policy (289). The State of Georgia seed law also makes further requirements concerning testing, declaration, and level of germination, licensing of vendors, and many other things. For this reason, the complete text of the act, including the most recent amendments, should be obtained from the Commissioner of Agriculture, State of Georgia, Capitol Building, Atlanta, Ga., before attempting to market seed in that State.

southern pines can be recommended only as a supplement to, not as a substitute for, the planting of nursery stock.

Repeated direct seedings of southern pines in many different localities during the past 40 years have resulted in occasional success (57, 417, 465, 513, 514, 539). Investigators have used the method in a number of studies to establish uniform stands over small areas (551, 572, 746). A very few attempts on a commercial scale have produced good stands, some of them a hundred acres or more in area (192, 314, 608, 760).

Some of the good stands just mentioned, however, have required exorbitant amounts of seed, or other costly investments. One "successful" direct seeding of loblolly pine required 13.5 pounds of seed per acre; one of longleaf pine required 25 pounds of seed per acre; another of longleaf required 13.5 pounds of seed per acre, plus high labor costs for sowing and mulching. In Missouri (361), out of more than 9,000 acres direct seeded, only 462 produced acceptable stands. Workers all over the southern pine region have reported similar unreliability of the method (3, 159, 193, 210, 470, 750). It is noteworthy that practically all the public and private agencies that pioneered in artificial reforestation with the southern pine tried direct seeding (some of them on units of a thousand or more acres, in several seasons, and by several different methods), and that without exception these agencies have turned to planting of nursery stock as cheaper and more dependable.

Unsatisfactory though direct seeding has been, commercial concerns may find it pays in years when seed is plentiful and nursery stock scarce, or when large areas severely burned over must be restocked quickly with pine to forestall hardwood brush. A farmer may be justified in sowing home-collected seed directly on the planting site, even if half his attempts fail. And repeated trials in many localities will most quickly develop the techniques needed to make direct seeding a more dependable supplement to planting. These ventures and trials are likely to waste effort, however, unless the problems involved are clearly understood."

Often the first obstacle which must be overcome is consumption of the seed by various mice (271), cotton rats, and birds—particularly meadowlarks, mourning doves, quail, and several kinds of blackbirds and sparrows. Other known eaters of southern pine seed include hogs, rabbits, shrews, armadillos, and crawfish. In one instance, ants were the principal destroyers of seed on 26,000 acres (525).

Even if the seed is not destroyed, cutworms, ants, and damping-off are likely to take a heavy

toll of the newly germinated seedlings (276, 417, 470, 601, 746, 802). Cutworms are abundant on many areas in the southern pine region at the same time that seedlings from direct seeding are at the most vulnerable age (198, 205), and these and other insects appear in general to be a greater obstacle to direct seeding than is commonly realized (259, 260, 634, 667).

The greatest hazard to direct seeding, however, and the hardest to predict or forestall, is drought. No matter how the site is prepared or when the seed is sown, a few dry days at any time between sowing and the good development of primary needles, or a prolonged drought at any time during the first growing season may kill most or all of the trees (397, 417, 470, 667).

Sowing from airplanes or helicopters, although it speeds up direct seeding and reduces labor costs, leaves the seed as exposed to birds, rodents, insects, damping-off, and drought as does broadcasting by hand.

Wire cones or domes (p. 214) effectively protect seed and seedlings in prepared spots from birds and rodents, and probably to some extent from drought. They sometimes fail, however, to protect them from insects (276). They also make direct seeding nearly as expensive as planting, if not more expensive, and in this way eliminate one of the principal advantages of direct seeding.

Mulching seed in spots or furrows to prevent bird and rodent depredations is less expensive than screening, but also less effective.

Disking the site exposes rodents to their enemies and conserves moisture in case of drought, but is expensive. Burning off a heavy rough, although it reduces rodent damage, brings the seed in contact with mineral soil, and is cheaper than disking, has caused frequent heavy losses from drought, birds, and freezing of seedlings.

Repeated tests of chemical repellents have revealed none effective in preventing bird or rodent depredations on direct-seeded southern pines or other pines (642). Even a successful repellent would not protect the germinating seed and young seedlings from drought.

"Pelleting" seed (54, 811), which is done commercially to permit control of spacing of agricultural crop plants in the row, offers little sound theoretical promise of improving the establishment of direct-seeded southern pines. It has failed to improve results in the field with two or three southern pines in at least two different States. In a third State, pelleting by two different processes very seriously reduced both germination and subsequent growth of all four principal southern pines even under ideal conditions in the nursery.

Decision to direct-seed should be made only with full understanding that success requires seed of the very highest quality (192, 285, 642), that positive steps must probably be taken to protect seed from birds, rodents, or both, and that drought or other causes may necessitate reseeding.

²²The following references describe many pitfalls to avoid and some useful leads to follow in developing improved methods of direct seeding: 57, 104, 166, 167, 192, 214, 262, 266, 271, 278, 285, 319, 321, 370, 390, 398, 402, 417, 465, 479, 498, 513, 514, 525, 539, 540, 634, 642, 701, 765, 771, 772.

SPACING AT WHICH TO PLANT

Choice of southern pille plantation spacing depends first of all on the number of trees per acre desired at the time of the first thinning,¹² and second, on survival.

The optimum number per acre will vary with the kind and quality of products to be grown (135, 215, 256, 378, 379, 534, 535, 537, 558, 559, 562, 691, 765, 766). In large-scale plantations under extensive management, the optimum number will usually be less—perhaps 400 per acre—than in small, intensively managed plantations where it may be 700 or more. The minimum number should not be so small as to waste growing space excessively while the trees are developing to merchantable size, cause excessive branchiness, or make the yield from the first thinning (table 4) uneconomically light. The maximum number should never be so large as to cause stagnation of the stand (p. 169) before the trees reach merchantable size (295, 537, 691, 766), or to increase the cost of establishment beyond what can be repaid from the products cut.

¹² Except in erosion-control plantations, in which the main purpose is to cover the ground at the earliest possible date, and timber production is secondary or impracticable. Such plantations often must be spaced more closely than those established for pulpwood and timber production.

When the number of trees desired at the time of the first thinning has been decided upon, enough more must be planted to allow for expected mortality. If about 700 trees per acre are desired, 8- by 8-foot spacing gives satisfactory results where survival is better than 95 percent, but a spacing of 6 by 6 feet or closer will be needed where survival is less than 60 percent (fig. 7 and table 5).

Very often (581), planters have assumed much higher survivals than are ordinarily attainable in their localities (194, 279), and have planted at spacings too wide to give satisfactory stands. This has been particularly true with longleaf pine, which suffers more mortality than other species after the first year in plantation (p. 5 and fig. 8), and which, because of its irregular height growth (fig. 3, A), is less likely than other species to stagnate at close spacing and more likely to be limby at wide spacing (fig. 9, D). Under any given set of conditions, longleaf should be spaced more closely than other species (197, 765, 766).

Most industrial, farm, and Forest Service planting with southern pilles has been at spacings ranging from 6 by 6 feet (1,210 trees per acre) to 8 by 8 feet (681 trees per acre). Wider and closer spacings, ranging from extremes of 2 by 2 feet (10,890 trees per acre) (404) to 16 by 16 feet (170 trees per

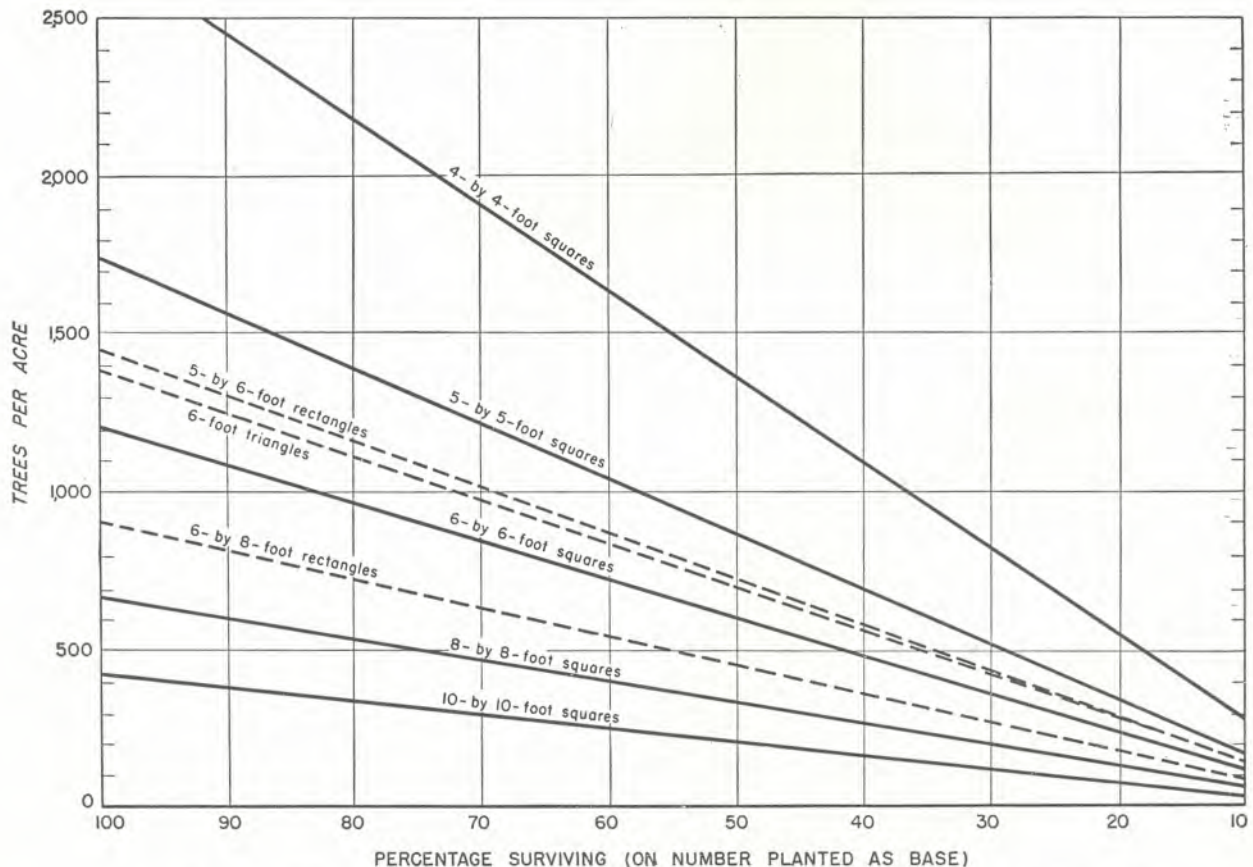

FIGURE 7.—Trees per acre at 8 initial plantation spacings and varying percentages of survival.

TABLE 4.—Effects of spacing upon yield of pulpwood from planted loblolly, slash, and longleaf pines

Species and location	Period since planting	Spacing	Survival	Pulpwood per acre	
				Total at end of period	Removed in thinning at end of period
	Years	Feet	Percent	Cords ¹	Cords ¹
Loblolly pine:					
Auburn, Ala. ^{2 3}	14	4 by 4	70	19.0	
		6 by 6	81	24.9	
		8 by 8	83	22.1	
		9.6 by 9.6	88	16.7	
		12 by 12	86	16.1	
		16 by 16	91	12.5	
Bogalusa, La.	15	5 by 5	86	14.8	
		6 by 6	91	12.2	
		8 by 8	93	10.4	
Woodworth, La. ⁴	20	4 by 4	44	27.4	10.8
		6 by 6	61	29.9	11.9
		8 by 8	78	31.0	10.7
		10 by 10	74	27.0	8.3
Slash pine:					
J. K. Johnson Tract, La. ⁵	12	4.3 by 4.3	53	11.9	
		5.2 by 5.2	59	10.0	
		6.2 by 6.2	63	9.6	
		13.1 by 13.1	66	4.1	
Lake City, Fla. ⁶	13	8 by 8	90	25.9	
		10 by 10	90	19.5	
		12 by 12	90	18.1	
Tallahassee, Fla. ⁶	13	8 by 8	90	34.8	
		12 by 12	90	20.2	
		16 by 16	90	10.8	
Auburn, Ala. ^{2 3}	14	4 by 4	73	28.6	
		6 by 6	77	31.0	
		6 by 8	84	22.9	
		8 by 8	76	17.3	
		9.6 by 9.6	79	17.5	
		12 by 12	76	15.5	
		16 by 16	82	10.6	
Bogalusa, La. ⁷	15	5 by 5	85	18.6	5.2
		6 by 6	91	16.2	5.6
		8 by 8	90	13.2	2.4
Longleaf pine:					
Auburn, Ala. ³	14	4 by 4	35	7.2	
		6 by 6	42	8.6	
		8 by 8	40	3.8	
		9.6 by 9.6	58	6.2	
		12 by 12	52	4.8	
		16 by 16	64	3.3	
Bogalusa, La.	20	6 by 6	58	13.4	
		8 by 8	58	11.4	
		10 by 10	69	8.9	

¹ Standard cords of unpeeled wood. All trees 4 inches d. b. h. and larger, except in the slash pine plantations at Lake City, Tallahassee, and Bogalusa, where yields are for trees 5 inches d. b. h. and larger.

² STAHELIN, R. PLANTATION SPACING AND WOOD PRODUCTION. South. Forest Expt. Sta. South. Forestry Notes 56, pp. 3-4. 1948. [Processed.]

³ WARE, L. M., and STAHELIN, R. HOW FAR APART SHOULD PINES BE PLANTED? South. Lumberman 173 (2177): 191-193, illus. 1946.

WARE, L. M., and STAHELIN, R. GROWTH OF SOUTHERN PINE PLANTATIONS AT VARIOUS SPACINGS. Jour. Forestry 46: 267-274, illus. 1948.

⁴ MUNTZ, H. H. PROFIT FROM THINNING VARIOUSLY SPACED LOBLOLLY PINE PLANTATIONS. South. Lumberman 177 (2225): 125-128, illus. 1948.

⁵ MUNTZ, H. H. ICE DAMAGE TO PINE PLANTATIONS. South. Lumberman 175 (2201): 142-145, illus. 1947.

MUNTZ, H. H. CLOSE SPACING REDUCES FUSIFORM RUST. South. Forest Expt. Sta. South. Forestry Notes 57, p. 1. 1948. [Processed.]

⁶ FLORIDA FOREST AND PARK SERVICE. PROFITS FROM PLANTED SLASH PINES. Fla. Forest and Park Serv. Cir. 5, 3 pp., illus. 1944.

⁷ BULL, H. YIELDS FROM 3 SPACINGS OF PLANTED SLASH PINE. South. Forest Expt. Sta. South. Forestry Notes 51 p. 2. 1947. [Processed.]

TABLE 5.—Trees per acre at 17 initial plantation spacings and varying percentages of survival 1

Spacing (feet)	Area per tree	Number of trees per acre at survival percentage of—								
		100	90	80	70	60	50	40	30	20
Squares:										
4 by 4.....	<i>Square feet</i> 16	2, 722	2, 450	2, 178	1, 905	1, 633	1, 361	1, 089	817	544
5 by 5.....	25	1, 742	1, 568	1, 394	1, 219	1, 045	871	697	523	348
6 by 6.....	36	1, 210	1, 089	968	847	726	605	484	363	242
7 by 7.....	49	889	800	711	622	533	444	356	267	178
8 by 8.....	64	681	613	545	477	409	340	272	204	136
9 by 9.....	81	538	484	430	377	323	269	215	161	108
10 by 10.....	100	436	392	349	305	262	218	174	131	87
12 by 12.....	144	302	272	242	211	181	151	121	91	60
Rectangles: ²										
5 by 6.....	30	1, 452	1, 307	1, 162	1, 016	871	726	581	436	290
4 by 8.....	32	1, 361	1, 225	1, 089	953	817	680	544	408	272
5 by 8.....	40	1, 089	980	871	762	653	544	436	327	218
6 by 7.....	42	1, 037	933	830	726	622	518	415	311	207
6 by 8.....	48	908	817	726	636	545	454	363	272	182
5 by 10.....	50	871	784	697	610	523	436	348	261	174
6 by 10.....	60	726	653	581	508	436	363	290	218	145
Equilateral triangles:										
6³.....	31	1, 397	1, 257	1, 118	978	838	698	559	419	279
7⁴.....	42	1, 027	924	822	719	616	514	411	308	205

¹ Spacings well proved in practice, or theoretically desirable, are in bold-faced type.

² Wider spacing between rows than between trees in row.

³ Distance between trees 6 feet; distance between rows approximately 5.2 feet.

⁴ Distance between trees 7 feet; distance between rows approximately 6.1 feet.

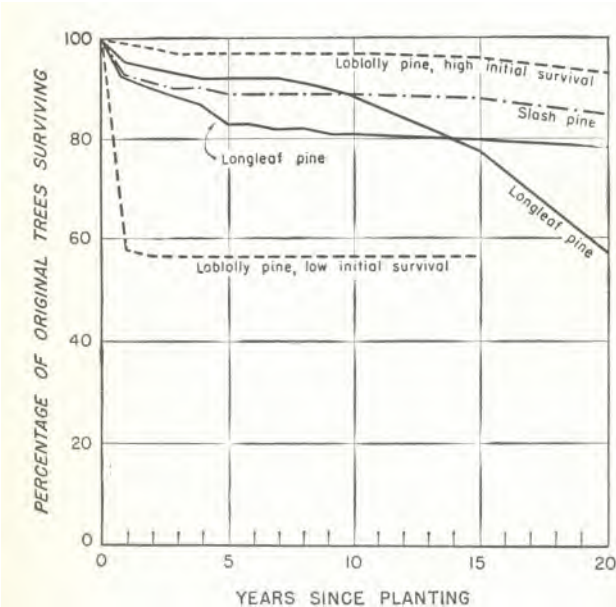

FIGURE 8.—Typical survival patterns of planted loblolly, slash, and longleaf pines, Bogalusa, La. The two longleaf plantations had almost identical initial survivals, but their mortality from brown-spot needle disease and other causes differed conspicuously during the next 19 years.

acre) (193), although recommended by numerous authors, have been little used. The 6- by 6- to 8- by 8-foot spacings have, on the whole, worked fairly well, though opinions differ as to how perfectly they have met individual needs. The writer

considers that far more southern pine plantations have been marred by too wide than by too close spacings. The following specific choices of spacing are therefore recommended.

Recommended Spacings

1. Where good and accessible markets for pulpwood, posts, or smaller products within 13 to 15 years after planting seem reasonably assured, plant loblolly, slash, and shortleaf pines at 5- by 6-foot spacing on farms and 6 by 6 on industrial holdings. On either type of ownership, plant longleaf pine at 5- by 5-foot spacing.

2. Where markets for pulpwood, posts, or smaller products seem uncertain and where plantation survival is generally 80 percent or higher at 15 years, plant loblolly, slash, and shortleaf pines at slightly wider spacing, as 6 by 7 or 6 by 8 feet, but never wider than 8 by 8 feet; plant longleaf at 6 by 6 feet. If there is strong local evidence that survival is likely to be below 70 percent at 15 years, plant longleaf at 5 by 6 and other species at 6 by 6 feet, regardless of prospective outlets for products.

3. On farms on which wood from early thinnings can be used or sold for domestic fuel, plant all species at 5- by 5-foot spacing.

4. Use 4- by 4-foot spacing only in erosion-control plantations where quick, complete coverage of the ground is essential and initial mortality is likely to be high.



F-465219, 465220, 465221, 465222

FIGURE 9.—Slash pine (A and B) and longleaf pine (C and D), 141 years after planting at 4- by 4-foot (left) and 8- by 8-foot spacing at Auburn, Ala. At 4- by 4-foot spacing the live crowns of the slash are too short and growth has stagnated; at 8 by 8 the slash, despite high survival, is somewhat limby. Because of its much better crown differentiation, the longleaf at 4 by 4 still has long live crowns and has not yet stagated; at 8 by 8 it is excessively limby. The ground vegetation in D shows that the trees have not yet begun to use all the growing space.

Following these recommendations involves, in general, somewhat closer plantation spacings than have been customary in the southern pine region.

Spacings much wider than those hitherto used in the South have been adopted in South Africa for use with exotics, including the southern pines (195, 196), and have been cited in the American literature (137, 168, 197). Although these wider spacings appear attractive because of their low per-acre costs for planting stock and planting labor, and the early attainment of large diameters, they have been developed to fit climatic, soil, and economic conditions radically different from those in the South (195, 721), and they involve heavy costs for replacement planting, repeated artificial pruning, and other plantation care. They are not recommended for commercial use in the southern pine region until the good results obtained with them in South Africa shall have been substantiated experimentally under local conditions in the South.

Arrangement of Trees in Other Than Square Spacings

The spacings so far discussed have been square or rectangular (5 by 5 to 8 by 8 feet, or 5 by 6 to 6 by 8 feet). In these spacings the distance between rows is little if any greater than the distance between trees in the row, so that each tree is about equally crowded on all sides.

When trees at a given number per acre are planted in plowed furrows or by machine, it reduces costs to increase the distance between rows and to decrease correspondingly the distance from tree to tree along the row. The widely popular 6 by 8 spacing was originally substituted for 7 by 7 spacing because it reduced the cost of plowing furrows about 12 percent, with no increase in the cost of hand planting.

Still longer, narrower rectangles, such as 5 by 10 or 4 by 12 feet, would make correspondingly greater savings in cost of machine operation. It seems likely, however, that at some point such modifications must affect form or growth unfavorably by overcrowding the trees in the row. Until experiments have disproved the likelihood of such unfavorable effects, extremes of rectangular spacing like 4 by 12 feet cannot be recommended for general use. There is little merit in the argument that such spacings admit tracks between the rows. At any commonly used square spacing it has proved practical and profitable to cut truck trails along the best mutes at the time of the first thinning and to utilize the trees removed.

Planting in equilateral triangles¹³ instead of in squares or rectangles makes best use of space.

¹³ Such triangular arrangement allows 15 percent more trees per acre with a given distance between trees, or 7.5 percent greater distance between trees with a given number of trees per acre, than does square spacing. Theoretically, therefore, it may serve as insurance against replanting if mortality is high, or against stagnation if mortality is low and thinning must be postponed (73).

Practically, however, it requires more care in alignment than is ordinarily justifiable in hand planting, and it is impossible to apply rigorously in any type of machine planting so far developed.

MEANS OF OBTAINING PLANTING STOCK

The planting stock used for the great majority of southern pines consists of bare-rooted 1-year-old (1-0) nursery-grown seedlings.

Most farmers buy such stock from large, centralized, permanent State nurseries. In all the Southern States, orders for stock from the State nurseries may be placed directly with the State foresters; in some States they may be placed also through district foresters, county agricultural agents, or other designated officials. It is advantageous to both the purchaser and the State forester to have orders placed by May or earlier in the spring preceding planting.

Most Federal and State agencies and a few industrial operators grow their own nursery stock. Such planters may have to choose between establishing large, centralized nurseries or small, local ones, or between establishing permanent or temporary nurseries. Choice depends on individual circumstances, but several points should be considered, especially in deciding doubtful cases.

The planter who produces his own nursery stock has better control over the geographic source of seed used than do planters who buy stock. He also has much better control over lifting and shipping schedules. On the other hand, producing good stock in regular quantities every year requires knowledge and experience frequently not available to the small-scale planter. It also requires investments in soil and equipment which the small-scale planter may consider justified only if he is unable to buy stock elsewhere.

In general, the larger the nursery the less the cost per thousand trees for technical manpower and modern nursery equipment. This has been the principal reason for the development of a few large southern pine nurseries, usually with capacities of 10 to 30 million trees a year, rather than a much larger number of smaller nurseries. It is, however, much easier to find a good nursery site with a capacity of 1 to 5 million trees a year than an equally good one with a capacity of 10 to 20 million trees a year.

Although definite data are not available, it is suggested that an industrial concern with a competent forestry staff and a planting schedule of 3 to 5 million trees a year may find it more economical to grow its own nursery stock than to buy it. Under exceptionally favorable circumstances, such firms may save money by growing their own stock even for programs requiring less than half a million trees a year.

For plantations on numerous individual farms, and on certain adverse sites in some extensive

planting programs, "ball-planted" natural seedlings may give better results than bare-rooted nursery stock, and at similar or lower costs (147, 338, 524, 525, 706). The essential requirement is a supply of natural seedlings of the right size and on suitable soil within 3 miles of the planting site. Special tools and techniques for such planting are described on p. 227.

Natural seedlings are likely to have root systems too poorly developed for successful bare-root planting (384), and attempts to use them for such planting have become rare.

WHAT CONSTITUTES PLANTABLE LAND

Exactly what land to plant must be determined in the light of local circumstances—soil, erosion, markets for products, characteristics of existing plant cover, and opportunities for releasing trees from competing vegetation. Workable definitions of plantable land are essential in estimating requirements for planting stock. Without such definitions, also, some crews will waste stock by planting it where it cannot thrive and others will waste space by leaving favorable sites unplanted.

Abandoned fields and cutover longleaf sites with good soil, free from brush, near good markets, localities where planting generally succeeds, and ^{lacking} both seed trees and established seedlings, are obviously plantable. The difficulty comes in drawing the line between less favorable yet still plantable sites, and really unplantable land.

As a general guide, land may be considered unplantable for the six following reasons, alone or in combination

1. Enough reproduction, either natural or from previous planting, to occupy the site satisfactorily.
2. Good likelihood of sufficient natural reproduction from seed trees on or next to the site, within the next 1 or 2 good seed years. (In Florida, some companies consider it more profitable to plant than to wait even 3 to 6 years for natural restocking (194).)
3. Remoteness from sure markets. Few tracts in the South are unplantable for this reason alone, although distant from established markets may combine with other conditions to make land unplantable or to make wide spacing advisable.
4. Soil so poor that acceptable survival cannot be attained, or that subsequent growth cannot repay the cost of planting no matter how cheap the planting or how good the initial survival. Many deep, coarse sands, some excessively wet or dry soils, and occasional rocky soils fall within this classification. So do some eroding sites on which other plants will stop erosion as effectively as pines, and at a lower cost.
5. Need for using special and excessively costly preplanting and planting techniques to insure success. This situation exists on some very brushy sites, some poorly drained sites, and on many sites

on which erosion can be controlled more cheaply with other plants than with pines.

6. Conditions under which no known planting technique gives reasonable promise of success.

In deciding whether there is enough reproduction present to occupy the site satisfactorily, Region 8 of the U. S. Forest Service (736) has considered land within the southern national forests as definitely plantable if it averaged fewer than 250 milacres¹⁴ per acre occupied by established seedlings, and usually or probably plantable if it averaged 250 to 500 milacres so occupied (pp. 121-122). On the other hand, plantations have not been classified as failures needing replanting until mortality has left, on the average, fewer than 100 to 250 milacres per acre occupied by either natural seedlings or planted trees (p. 165).

Region 8's rules have proved practicable in large-scale planting on the southern national forests. In planting for intensive management, as on farms or close to pulp mills, land with even more than 500 occupied milacres per acre might be considered as definitely plantable.

On a vast acreage of eroding land, reasons 4 and 5 for considering land unplantable must not be applied too literally.¹⁵ On such sites planting often is necessary and amply justified to reduce runoff and erosion, even if there is good evidence that the wood produced will not repay the costs of planting. In no extended program (195), moreover, is it economically possible to plant only the best areas.

The general tendency to plant clear land first and leave brushy areas until later may not always be wise. If the brushy areas are much more expensive to plant, and give poorer survival and growth, planting the open areas first may, indeed, be the most profitable procedure. Experience gained on the open sites may help improve results in the brush, and the brush itself may become easier to plant as it grows older. Planting the brushy sites first may be more profitable, however, if they are potentially more productive than the open sites (616), or if the presence of some brush improves survival (545, 616), or if planting becomes more difficult and expensive as the brush grows older. No general rule can be given; the best time to plant the brushy areas must be decided in the light of local circumstances.

PLANTING COSTS AND PLANTATION YIELDS

Average southern pine planting costs and plantation yields are much in demand as guides to planting policies and to plans for new planting

¹⁴ Thousandths of an acre; in practical reconnaissance and planting surveys, mutually exclusive squares 6.6 feet on a side.

¹⁵ This is true also of spoil banks left from strip mining; these frequently require planting to reduce unsightliness or to comply with State law.

programs. There are few situations, however, in which any such averages now available can be used effectively without considerable modification or correction.

Few complete cost figures have been published. All those so far compiled have soon been put out of date by technical advances and by changing wage scales. Growth and yield data are less subject than costs to change with passage of time, but good growth and yield data are available for plantations only up to 20 or 25 years old. Most important of all, local circumstances cause such large variations in costs, growth rates, and yields that general averages seldom indicate dependably the costs of or yields from individual plantations. For these reasons, the information that follows may be at best only rough approximations of

future costs and yields and should be scrutinized and corrected in the light of current local conditions and experience.

Overall Costs

The most comprehensive and complete figures on the cost of planting the southern pines are those of the U. S. Forest Service for producing 196 million trees and outplanting 187 million during the period 1937-38 through 1941-42 (table 6). In addition to showing absolute costs under explicitly recorded conditions, these figures demonstrate several important relationships between seed, nursery, and field-planting costs for different southern pine species (pp. 65, 119-120, and 145-147).

TABLE 6.—Average costs per thousand trees planted, Region 8, U. S. Forest Service, 1937-41¹

Species, nursery, ² and element of cost ³	Nursery season					Weighted average
	1937	1938	1939	1940	1941	
Longleaf pine (Ashe Nursery):	<i>Dollars</i>	<i>Dollars</i>	<i>Dollars</i>	<i>Dollars</i>	<i>Dollars</i>	<i>Percent</i>
Seed.....	1.42	1.27	0.82	0.78	1.11	17.2
Nursery.....	1.65	2.43	2.31	1.92	2.83	35.7
Planting.....	2.97	2.92	2.71	2.85	3.04	47.1
Total.....	6.04	6.62	5.84	5.55	6.98	100.0
Longleaf pine (Stuart Nursery):						
Seed.....	1.29	1.11	1.62	.65	.87	15.7
Nursery.....	2.53	2.81	2.41	2.03	3.03	35.8
Planting.....	4.56	3.07	2.92	3.13	3.48	48.5
Total.....	8.38	6.99	6.95	5.81	7.38	100.0
Slash pine (Ashe Nursery):						
Seed.....	.50	.92	1.20	.80	2.72	14.5
Nursery.....	1.65	2.43	2.31	1.92	2.83	40.4
Planting.....	2.35	2.49	2.52	2.49	2.69	45.1
Total.....	4.50	5.84	6.03	5.21	8.24	100.0
Slash pine (Stuart Nursery):						
Seed.....	.46	.63	.63	.44	.57	9.1
Nursery.....	2.53	2.81	2.41	2.03	3.03	43.3
Planting.....	3.21	1.06	4.41	3.29	4.32	47.6
Total.....	6.20	4.50	7.45	5.76	7.92	100.0
Loblolly pine (Ashe Nursery):						
Seed.....	1.32		1.21	.68	1.94	18.6
Nursery.....	1.65		2.31	1.92	2.83	26.6
Planting.....	11.49		4.54	4.46	3.44	54.8
Total.....	14.46		8.06	7.06	8.21	100.0
Shortleaf pine (Ozark Nursery):						
Seed.....	.24	.37	.77	.21	.37	3.4
Nursery.....	4.70	10.11	4.92	3.29	5.58	48.9
Planting.....	6.51	6.56	4.83	4.38	3.77	47.7
Total.....	11.45	17.04	10.52	7.88	9.72	100.0

¹ Seed and nursery costs based on 196 million trees, planting costs on 187 million trees.

² Ashe Nursery, Brooklyn, Miss.; Stuart Nursery, Pollock, La.; Ozark Nursery, Russellville, Ark.

³ Nursery costs include lifting, grading, and packing. Planting costs include preparation of site (except fencing) and transportation and planting of stock.

The work on which these costs were based was done mostly by Civilian Conservation Corps enrollees at a computed labor charge of only \$1.50 for a 6- to 6½-hour day. The balance was almost entirely by Works Progress Administration labor. All the planting was done by hand, practically all of it with planting bars. The costs shown include not only all direct labor charges, but also all shipping charges for cones, seed, and planting stock, maintenance and depreciation of all equipment and buildings, maintenance of soil fertility in nurseries, and all direct administration including technical supervision by nurserymen and the salaries of nursery shipping clerks. They exclude, however, the cost of planting reconnaissance and reexamination, most plantation fencing, and all overhead supervision.

The costs were recorded after the nurseries were well established, the initial difficulties had been largely overcome, and the principal operations (such as sowing and lifting) had been mechanized. The nurseries were producing at very nearly their rated capacity during the period in question, and were therefore as efficient, economically, as the layout would permit.

Although these costs are in terms of a thousand trees produced or planted, they are also closely equal to the U. S. Forest Service costs per acre for the period noted. Most of the planting was at 6- by 6-foot spacing, or 1,210 trees per acre, but established seedlings, large trees, or clumps of inplantable brush reduced the number of trees actually planted to about 1,000 per acre.

The costs per thousand trees varied as follows : seed, from \$0.21 to \$2.72; total nursery costs exclusive of seed, from \$1.65 to \$10.11; shipping and field planting costs, from \$1.06 to \$11.49; total costs, from \$4.50 to \$17.04. In the face of such variations within the operations of one large, stable organization with a relatively specialized form of land ownership—the southern national forests—a single, overall average planting cost is practically meaningless. For this reason no such overall average has been included in table 6.

Special Costs

An important point in connection with field planting costs is that it is practically always cheaper to forestall injuries (p. 148) known to threaten the planted trees than it is to lose established plantations or to replant. Reasonably good fire control, for example, is essential to success with all species, including the fire-resistant longleaf, and should be established before planting begins.

Fencing against hogs is almost invariably necessary with longleaf pine, and may be with slash pine where hogs eat the roots of this species also. It should be completed before planting starts. To minimize costs per acre, lumber and pulp companies and the U. S. Forest Service usually fence approximately square or roughly circular units of

10 to 30 thousand acres each. Sites occupied by scattered longleaf seedlings that are already infected with brown spot often should be prescribed-burned before planting with longleaf, to delay brown-spot infection of the planted trees.

Pocket gophers and leaf-cutting ants, if they exist on the planting site, should be eradicated or at least greatly reduced before planting begins. Funds should be provided for inspection after planting and for further control as needed.

The principle of forestalling predictable injuries rather than gambling upon chance escape applies to seed treatment and nursery practice as well as to field planting. It is cheaper to pay the slight extra cost of cold storage on all seed lots than to weaken or ruin even a few lots by storing them at air temperature. Longleaf stock in the nursery must almost invariably be sprayed to prevent brown-spot infection. Slash pile seedlings must be sprayed faithfully to prevent southern fusiform rust in any nursery subject to this disease. Where such destructive pests as cutworms, mole crickets, red spiders, scale insects, or white grubs are likely to attack, it is cheaper to have the proper insecticides on hand than to be caught without them when trouble strikes.

Plantation Growth and Yields

The plantations established at Bogalusa, La., by the Great Southern Lumber Co. (now owned and managed by the Gaylord Container Corp.) are the preeminent source of data on the growth and yields of extensive plantations of southern pines. Nearly 13 thousand acres of southern pines were planted at Bogalusa alone between 1920 and 1926. Prior to 1926, other successful plantations in the South did not total 500 acres. Representative yields from various plantations at Bogalusa are as follows (810) :

a. Eight hundred acres of direct-seeded loblolly pine averaged 21 cords per acre in 28 years, or 0.75 cord per acre per year. The best portion ran 34 cords per acre, or 1.21 cords per acre per year.

b. Twelve hundred acres of planted loblolly pine (wild stock) averaged 22.5 cords per acre in 26 years (including 2.7 cords removed in thinning at 18 years) , or 0.87 cord per acre per year.

c. Seven thousand acres of longleaf pine averaged about 10 cords per acre at 20 years, or 0.5 cord per acre per year. The best portion averaged 27.3 cords per acre at 20 years, or 1.36 cords per acre per year.¹⁶

d. Six thousand five hundred acres of slash pile averaged 37.7 cords per acre at 24 years, or 1.57

¹⁶This most successful portion of the plantation was burned over, during the second winter after planting, by a quick, hot fire which caused negligible mortality but which effectively controlled brown spot and resulted in early height growth. Over large portions of the burned area, survival 18 years after planting was still 85 to 95 percent.

cords per acre per year. First thinnings, begun at 24 years, yielded approximately 10 cords per acre.

Figure 10 shows a portion of the slash pine dseriad in *d* as it looked 20 years after planting. Such stands, representaiva of much of the slash pine, the better loblolly, and a little of the best longleaf planted at Bogalusa, may be thinned profitably for pulpwood from the 13th to the 15th year onward (the 20th with longleaf), with ample trees left for future cuts of pulpwood, poles, sawlogs, and piling.

Many faster growth rates and higher yields than those just cited have been reportad. Loblolly and slash pines have grown at average rates of 1.4 to 2.3 cords per acre per year for the first 13 to 22 years after planting. Shortleaf pine in southern Illinois has averaged 1.0 cord per acre per year the first 13 years after planting. Loblolly in New Jersey has yielded 5,000 board feet per acre 20 years after planting. Thirteen-year-old slash pine planted at 12- by 18-foot spacing in Florida has produced 21 barreis of gum per thousand faces and grossed \$1,360 worth of gum in 1 year from half the trees on 40 acres. (2, 15, 16, 194, 269, 342, 395.)

For two reasons, however, reports like these should be discounted somewhat in estimating probable plantation yields. First, such reports are almost invariably based on small plantations or plots of exceptionally full, uniform stocking. Second, there is a strong tendency for only maximum or near-maximum yields to find their way into print. None of the yields cited in the preceding paragraph, for example, is less than 1.0 cord per acre per year. Bv contrast, yields of equally old 6- by 6- to 8- by 8-foot plantations tabulated in other sections of this monograph range downward from comparable levels to 0.3 cord per acre per year for loblolly pine, 0.7 cord for slash, and 0.3 cord for longleaf.

Any more precise estimate of future growth than can be made from the figures already given here must depend, for some time to come, on data from plantations in the vicinity of the planting sites and on data from natural stands on comparable sites nearby.¹⁷ In attempting such improved estimates, it must be remembered that : (a) planting a species on a site to which it is ill adapted may seriously reduce survival and is almost certain to reduce growth and yields; (b) using planting stock

¹⁷ Planters sometimes misjudge the rate of growth of their longleaf plantations, as compared to that of natural stands, because they count age from known dates of planting or of nursery sowing, and forget that age of natural longleaf stands is determined, by convention, from stump counts plus 5 years or from age at breast height (4½ feet above the ground) plus 7 years. Provided the seedlings are thrifty and have started active height growth, the planter need not be unduly alarmed if his longleaf plantation fails to average breast height 6 years after planting and 7 from seed. If the truth were known, the natural stand probably also failed to average breast height in 7 years.

of unsuitable geographic race may and in specific cases has reduced yield, sometimes to less than half (table 3 and fig. 6); (c) some planting sites, such as badly eroded old fields, are poorer than any on which natural reproduction takes place. With these exceptions, there is no good evidente and no logical reason for supposing that stands established artificially will differ much from natural stands in rate of growth.

RECORDS AND LOCAL TESTS

Costs can be reduced and results improved by assembling and using reliable local information on seed, nursery, and planting conditions. Such information is invariably needed to help fit general practices to local needs. Part of it can be derived from routine operations. Part, however, ordinarily will require simple but systematic tests of contrasting treatments. Sound policy must recognize this and provide for accurate systems of record keeping and testing.

Records

A vast quantity of local information becomes available in the ordinary course of work. Examples are rates of cone collection; yields of seed under current conditions and practices ; time, labor, machine operation, and materials needed for various nursery jobs ; stands of living and of plantable nursery seedlings from sowings at various dates and at various rates; rates of planting on various sites ; dates of occurrence of common plantation injuries; and the effects of local climatic peculiarities on seed collection, nursery practice, and planting. Systematically compiling information of this sort at the time it becomes available should be recognized parts of the extractory operator's and nurseryman's jobs, and of the planting supervisor's job in any extensiva planting program. The records should be strictly limited, however, to those that promise dividends in the form of more effective practices. No record should be kept unless its future use is clearly foreseen.

The absolute minimum record for each lot of seed and of nursery stock and for each plantation (pp. 14-16 is the State and county ¹⁸ (or national forest ranger district) of seed origin. Over-all planting costs are a minimum requirement for planting records wherever it is desired to calculate profits from plantations. It is believed that in the great majority of cases something between the least and the most detailed records suggested on pages 67, 120, and 147 will result in the greatest technical and economic benefits for the effort involved. Further suggestions concerning records are given in the literatura (401, 623).

¹⁸ For legal requirements concerning record of origin of seed sold in Georgia, see footnote 10, p. 16.

FIGURE 10.—Slash pine 20 years after planting on cut-over longleaf pine land at Bogalusa, La. The dominant and co-dominant trees compare favorably in size with the poles carrying the Rural Electrification Administration powerline along the road.



F-465223

Local Tests

Small advance tests of proposed new treatments often point the way to improved results and sometimes prevent serious trouble.

Large-scale applications of locally untried seed, nursery, and plantation treatments are risky. They should be avoided wherever possible. When they do have to be applied, the minimum precaution is to put in at least one contrasting treatment on a few small samples of the seed or seedlings given the large-scale treatment.

For example, a nurseryman may use a new and untried fertilizer over an entire nursery and lose the whole seedling crop. Without check plots, he has no way of telling whether the failure resulted from the new fertilizer or from some other influence. A soils specialist or plant pathologist may be equally unable to solve the problem unless he can examine some specimens grown in the same nursery in the same year but with some contrasting fertilizer (223). Depending on circumstances, the treatment applied on the check plots may be the one regularly used before or an alternative. The essential thing is that the test involve

a genuine and logical contrast to the new large-scale treatment.

The usefulness of local tests extends to practically all phases of seed handling, nursery, and planting technique. If small test lots of seed or stock are treated by one or more contrasting methods, contrast in results almost invariably develop, and very often show the source of any trouble that may have arisen, or lead to improved results.

Examples illustrating possibly combinations of contrasting test treatments and locally unproved large-scale treatments are: When a new cone kiln is installed, a few test lots of seed should be extracted in the old kiln, or at air temperature, to make sure the new kiln is not reducing the quality of the seed. When a new dewinger is installed, a few test lots of seed should be dewinged with the old dewinger or by hand. New methods of seed storage or of pregermination treatment should be checked against test lots of seed differently stored or pretreated. Drastic changes in nursery sowing date, seedbed covers, fertilization, chemical weeding, spraying for insects or disease, machine lifting, packing and stock storage, and changes in planting site preparation and planting technique

should be checked against methods formerly effective or at least against alternative new methods.

Such tests should be applied to several small lots of seed or to several widely separated small plots in the nursery or plantation, both to insure against accidents and to average out variations in seed, in soil, and the like. Preferably, the tests should be repeated for at least two successive years, to make sure that the treatment finally adopted is effective despite differences in weather, insects, or diseases from year to year. Results of both the small-scale tests and the large-scale treatments should be carefully recorded to make the information available for future use.

SAFETY

Seed, nursery, and planting operations involve the risks associated with trucks, tractors, and farm machinery, plus some special hazards of their own. Special hazards include falling, or being struck by falling objects (especially cone hooks) while climbing for cones ; fire in seed-extracting plants using artificial heat ; inhaled dust and dust explosions in seed-cleaning plants; poisoning by rodent poisons, insecticides, and fungicides; explosions of certain fumigant insecticides and fun-

gicides ; injury to the hands from moving parts of machinery, especially mechanical grading tables with revolving blades to prune seedling rolls ; cutting of the feet with planting bars; falls, blows from bent brush or flying objects, or injuries to the hands while operating planting machines; and burns during preparation of planting sites or prescribed burning of longleaf plantations.

Sound policy and the sheer cost of accidents require constant effort to eliminate hazardous processes, to design machinery and equipment for greater safety, to train foremen and workmen in safe methods, and to enforce safety regulations. Smoking should be banned in cone sheds, seed-extracting plants, seed-cleaning rooms, and during the use of flammable or explosive fumigants such as carbon disulfide. The utmost care (p. 202) must be exercised in using any poison, caustic, or acid. Any carelessness or horseplay with edged tools, including planting bars, should be rigorously discouraged.

Foremen should be required and crewmen should be encouraged to qualify in first aid. This training develops safe working habits, and, if an accident occurs, one man trained in first aid may prevent much suffering, or even a death, among any crew of which he is a member.

SEED

Seed affects many details of southern pine planting not discussed in connection with policy. Characteristics inherent in the seed or acquired during collection and storage govern several key phases of nursery practice. The germination temperatures required, for example, determine the feasible and optimum sowing seasons for each species. Within species, the germinability of an individual seed lot principally determines the correct nursery sowing rate. Any treatment of the seed that reduces germination percent increases the cost per thousand seedlings produced. When the number of plantable seedlings obtained per

hundred seeds falls very low, seedling cost skyrockets because of excessive outlay for seed (fig. 11), and correspondingly increases the total cost of planting.

SEED DEVELOPMENT

Southern pine seed takes two growing seasons to mature. In the Gulf States, slash pine usually pollinates in late January or early February, longleaf and loblolly in March, and shortleaf in April, but in longleaf pine (481), and presumably in the other southern pines also (697), fertilization does

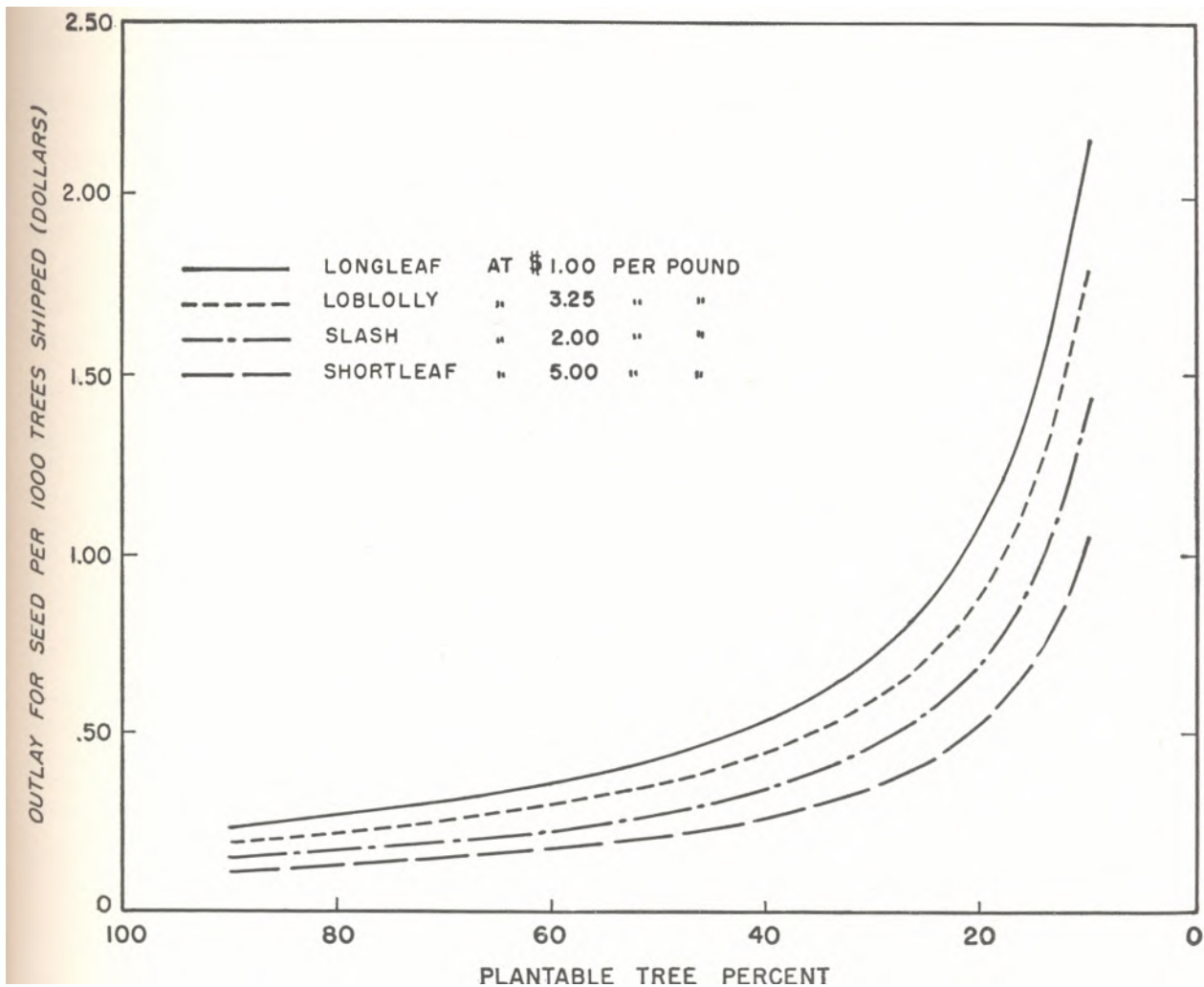

FIGURE 11.--Effect of plantable tree percent (that is, number of plantable seedlings obtained per 100 seeds sown) upon outlay for seed per thousand trees shipped. Shown for seed lots at representative erices and average numbers (p. 198) of seeds per pound.

not take place until May of the second spring. Adverse influences during the 14 months or so after pollination may easily prevent fertilization and setting of the seed.

After successful setting of even a few seeds per cone, the cones enlarge rapidly. They reach full size early in their second summer. Throughout the summer the cone tissues remain alive, transmitting water and nutrients from the tree to the developing seeds. During this period the specific gravity of the cones remains greater than 1.0.

As the second fall approaches, but before the cones become mature enough to open, the seeds become mature enough to germinate. Next, the cone tissues begin to die. Water from the tree no longer replaces all that lost from the surfaces of the cones, and the specific gravity of the cones accordingly begins to decrease. By the time the specific gravity has dropped to 0.89, the cones are still closed but have matured enough to open if picked and dried. Cones on the tree usually open at a specific gravity of about 0.70, shedding their seeds in the fall or winter at dates depending on species, location, and weather.

Among the four principal southern pines, the first seed may be shed only 20 or 21 months after pollination (slash pine); the last, in extreme cases (loblolly pine) (460), 26 to 27 months after pollination and 8 or 9 months after cones and seed have matured.

Pollination of pines is entirely by wind. Single pollen grains are undoubtedly blown many miles, but there is small chance of such individual grains reaching "cone flowers" (female strobili). For pollination to be assured, a tree must be literally deluged with pollen during the few days in which the cone flowers are open to receive it.

In longleaf pine, and apparently in other southern pines, the pollen of any particular tree is likely to mature and be shed before the cone flowers on the same tree are ripe to receive it. Wherever this occurs it reduces or prevents self-pollination and increases the likelihood of cross-pollination. Cross-pollination between trees of the same southern pine species may be the general rule, as it seems to be with some other conifers (39, 40, 346). Cross-pollination within species probably has a highly desirable effect on the vigor and adaptability of the resulting seedlings (355), but makes impossible the complete control of mole parentage except by laborious artificial pollination. Some control of mole parentage, however, is possible by collecting cones from stands which, either naturally or as a result of systematic cutting, contain only superior trees (427, 507).

With one exception, hybrids among the southern pines occur rarely, if at all. Longleaf and loblolly, the only two of the four principal species which pollinate simultaneously, frequently cross naturally to form the hybrid Sonderegger pine (*Pinus X sondereggeri* H. H. Chapman). The long-stemmed seedlings which distinguish this hybrid have appeared in nursery beds sown with

longleaf pine seed from practically every State in which longleaf grows in mixture with loblolly pine.

During the two seasons of its development, any seed crop in a southern pine stand may be reduced or destroyed by various influences. Flower buds may fail to form for any of several reasons not fully understood. Unseasonable cold may destroy the flowers. Rain may interfere with pollination. Insofar as cross-pollination is the rule, individual trees may yield few seeds per cone because too few neighboring trees shed pollen at the right time. Though pollination may be sufficient, fertilization may not take place. Insect attacks either the first winter or the second fall (in longleaf pine, by moths of the genus *Dioryctria* especially) have at one time or another reduced or destroyed the seed crops in many localities. There have been fairly clear cases of destruction of crops by drought—for example, shortleaf pine in Arkansas in 1936. These hazards combine to cause great fluctuations in seed production from place to place and year to year, and must be allowed for in planning collection or purchase of seed and in arranging for seed storage.

SEED PRODUCTION AND YIELDS

Frequeny and Extent of Seed Crops 19

There are occasional years of simultaneous heavy seed production by all species throughout most of the southern pine region. Tradition has it that 1913 and 1920 were such years, and the good general crop of 1935 is a matter of record. There also are years of widespread failure, like 1925 and 1945.

Such general bumper crops and failures recur in no predictable pattern. Moreover, they are rarely universal; Hall (297), for example, records an "enormous" crop of loblolly and shortleaf seed in southern Arkansas in 1925. For these and other reasons (p. 14), local seed crops of individual species are of more practical interest than general bumper crops or failures. This is particularly true because the average seed production of loblolly pine, and apparently that of longleaf and shortleaf pines also, varies more from place to place than from year to year.

Loblolly pine is only a moderately regular seed producer. It seeds most abundantly near the Atlantic and Gulf coasts; inland, it bears seed far less abundantly than has been commonly supposed (469, 756). In east central Alabama it produced little or no seed during the 6-year period 1940-45; in southern Arkansas (297) there were no heavy crops in the 13 years between 1925 and 1939;

¹⁹Data on seed crops have been assembled from more than 4,900 separate reports on the cone crops of southern pines from Maryland to Texas during 1931 to 1941, inclusive; from records of large-scale collections by the U. S. Forest Service in seven States; and from published reports of other large-scale collections and of numerous silvicultural investigations.

throughout most of the lower South, loblolly seed is in shorter supply than that of either slash or longleaf pine.

Slash pine is in general a good but irregular seed producer. Because of its narrower geographic range, slash is perhaps more liable to complete crop failures (as in 1925, 1939, and 1945) than the other principal southern pines.

Although extremely variable from year to year and place to place, the seed production of longleaf pine is better than has generally been assumed. In the Gulf States alone, the U. S. Forest Service succeeded in collecting 10,000 to 85,000 bushels of longleaf pine cones each year from 1934 through 1940, and nearly 10,000 bushels even in the poor seed years of 1941 and 1945.

The seed-producing capacity of shortleaf pine, like that of loblolly, seems to have been greatly overrated. Shortleaf is an infrequent seeder practically everywhere, and seems especially poor along the western and northern borders of its range and in the Ouachita and Ozark Mountains of Arkansas (297, 417, 469, 802).

Because of these facts, specific local crops cannot be predicted reliably from general information. Most collections must therefore be planned and carried out on the basis of field estimates (p. 32) of the cones about to mature in the localities from which seed is desired, and definite provision must be made to collect surplus seed from good crops and to store it effectively (p. 46).

Tree Characteristics Affecting Seed Production

As a rough guide in planning collections, heavy seed production should not be expected from trees smaller than 10 or 11 inches d. b. h. (75, 234, 417, 469, 746, 756). Trees as small as 6 inches d. b. h., however, often bear cones in commercial quantities, and, other things being equal, the smaller the tree the cheaper the cones are to collect.

Southern pine cones need never be rejected merely because of the age of the tree (503). Loblolly and slash pines 7 years old, shortleaf 9 years old, and longleaf 15 years old, have all produced fair to high percentages of viable seed (772, 773). Longleaf seed has been collected commercially from 20-year-old trees, and loblolly, slash, and shortleaf seed from trees only 12 to 16 years old. At the opposite extreme, excellent seed has been collected from shortleaf trees 280 years old (482) and longleaf 350 years old.

Within any age or size class, southern pines produce more seed if they are dominant, widely spaced, or open grown, provided always that they receive abundant pollen from other trees. (Inadequate pollination is thought to account for the frequently poor seed production of isolated trees.) Dense stands, especially if young or with very uniform crown canopies, usually have little seed. Cone crop estimates and other studies (433) suggest strongly that southern pines, like other timber

and game-food species (346, 784), yield cones and seed at the cost of some loss in wood production, and bear seed most frequently and abundantly when growing on the more fertile sites. Many individual southern pine trees, however, are consistently good or consistently poor seeders, almost regardless of size, site, or season (234, 568). Possibly the explanation lies in their own dates of pollination in relation to those of neighboring trees.

Yields Per Cone and Per Bushel

In round numbers, unopened longleaf cones run 100 to the bushel, slash 200, loblolly 500, and shortleaf 2,000.

In good seed years, longleaf may average 50 to 60 sound seeds per cone, slash 60 to 70, loblolly 40 to 50, and shortleaf 25 to 35. These numbers may be halved in poor years. The total number of sound plus empty seeds ranges upward to about 200 per cone.

Each of the four principal species averages about 1 pound of clean seed per bushel of cones in good seed years, about 0.5 pound per bushel in years of light to moderate crops, and 0.2 pound or less in very poor crop years. The same amount of seed almost always requires collection of more cones in poor than in average seed years.

The above averages and the extremes given on p. 198 are suitable for general planning of cone collection and seed extraction, but not for controlling large-scale operations or for computing final costs. Individual lots vary widely from the averages, especially in yields per bushel. Cones from young trees tend to average fewer to the bushel, and cones from very old trees more than the figures cited. For satisfactory control of large operations, data should be obtained by sampling the cone lots themselves.

Shortleaf seeds average about one-eighth of an inch wide and one-fifth of an inch long; longleaf, with wings reduced to stubs, average about one-fourth by two-fifths of an inch. Loblolly and slash seed are intermediate in size. These variations necessitate the use of different sizes of screens, seeders, and the like in extraction and sowing.

Cleaned longleaf seed with wings intact averages about 4,200 per pound; with the wings reduced, about 4,700. Cleaned and dewinged slash seed averages about 14,500 per pound, loblolly about 18,400, and shortleaf about 48,000. Young trees tend to have fewer and old trees more than the average number of seed per pound. With this exception, the sizes of seed and the weights of seed cleaned to a common standard (as 100 percent pure, 85 to 90 percent sound) are much more constant within species than are cone sizes or yields of seed per bushel of cones. The seed sizes and weights on p. 198 can therefore be used for planning almost all operations requiring such data. The chief exception is in calculating sowing rates in large nurseries, where control of seedbed density

through precise sowing is especially effective in reducing costs. Here local tables of seed weights should be used on each seed lot sampled.

ESTIMATING CONE CROPS

Although preliminary choice of a seed collecting ground depends on its geographic location (p. 14) and accessibility, on available labor and land ownership, and sometimes on logging schedules, final choice always depends on the supply of cones available. Therefore quantitative estimates of the collectible cones on one or several areas usually are necessary in deciding where to collect. Systematic estimates of the crop are superfluous only when the cones available obviously exceed the collector's needs.

As a starting point, any cone crop estimate requires a workable definition of collectible cones as well as some idea of the number of bushels to be collected. The definition depends on the nature of the seed trees and the method of collection (p. 34). The number depends on the quantity of new seed desired for sowing, storage, or sale. If the estimate shows an unexpectedly abundant crop, it may pay to increase the quota and collect extra seed for storage. If the estimate reveals few cones, the quota may have to be reduced, even though poor crops necessitate collecting extra cones to get a given quantity of seed.

Cone crop estimates need be only close enough to show that a particular collecting ground will yield a given quota of cones, or that one will yield the quota more economically than another. The method and intensity of an estimate will depend on the abundance of cones, the quantity desired, and the estimator's skill.

When the cone crop is fair to good and the collection quota is moderate, an experienced man can verify by eye the presence of the desired quantity while traversing the collecting ground on foot or even by car. To get equally reliable results under the same conditions, an inexperienced estimator usually must stop and count the collectible cones on sample trees, and convert the numbers to bushels. In any case, it is essential to see as much of the area as possible, rather than to make an overly precise estimate of the cones at one spot.

In poor seed years, or for large collections at any time, more intensive estimates are necessary to show the most suitable collecting ground.

A moderately intensive method of estimating involves stopping at many different parts of each proposed collecting ground and recording, on an appropriate form (fig. 12), quantities of cones on specific acreages. If the bushels of cones observed at the various stops do not total enough to meet the quota outright, the ratios in the right-hand column (preferably weighted by area) may be averaged and multiplied by the total acreage of seed-bearing stands to see whether the quota is available.

Proposed collecting grounds	: Bushels of collectible cones, not less than--	: acres on which observed	: Number of acres on which observed	: Rate of production per acre, at least
	: 100 : 10 : 1	: 1 : 10 : 100		
Bessie Tract:				Bushels
Stop No. 1	x	x		0.1
Stop No. 2	::	::		1.0
Stop No. 3	x	x		0.1
Etc.	- - - etc. - - -	- - - etc. - - -		

FIGURE 12.—Simple form for cone crop estimates.

The most intensive estimates are needed when large collections are planned and the crops are poor or spotty. Such estimates are made by counting or very carefully estimating all collectible cones on $\frac{1}{5}$ - or $\frac{1}{4}$ -acre sample plots at intervals along compass lines gridironing the prospective collecting grounds. (If the crop is spotty, the patches of best cone production should be mapped to guide the collecting crews.) Plot spacing is a matter of judgment. Region 8 of the Forest Service requires a minimum of 1 plot per 1,000 acres on units of 100,000 acres or larger (736). On areas of less than 6,000 acres, a plot every 40 to 80 acres may be needed.

The probable yield of seed per bushel of cones should be checked just before or in the early stages of collection, especially if the crop is poor. With patience and a little practice it is easy to estimate the number of filled seeds per cone to the nearest 20 or closer (p. 60). The averages for 1 or 2 cones apiece from 20 to 100 trees²⁰ on each area should show which collecting ground will give the best yield per bushel, or whether below-average yields per cone will necessitate collecting extra cones.

Forecasts of good cone crops made from counts of cone flowers or of yearling cones would often be a great help in planning seed collection and storage. Two obstacles, however, have prevented the development of such forecasts for southern pines. One is the impossibility of counting cone flowers or yearling cones accurately without climbing or felling the trees. The other is the erratic but often heavy mortality of cones during either their first or second season of development (p. 30). Reliable and useful forecasts (38) of cone crop failures in either the coming fall or the second fall thereafter can, however, be made from observation of a shortage or the complete absence of yearling cones or cone flowers, respectively.

Data for a forecast of the next crop may be obtained most easily and effectively from samples of seed trees (either standing or felled) during the

²⁰This method of sampling is necessary because numbers of full seeds per cone vary much more from tree to tree than from cone to cone on the same tree.

cone-collecting season. If the number of yearling cones is not greater than the number of mature cones on the same trees, the following year's crop will almost surely be smaller than the crop being collected.

COLLECTION AND CARE OF CONES

Successful collection depends upon : (1) Collecting at the right time—after the cones mature but before they start to open on the tree ; (2) employing, equipping, training, and supervising adequate crews ; (3) labeling the sacks of cones correctly ; and (4) taking proper care of cones between collection and extraction.

Cone Maturity

Since only mature cones can open and release their seeds, everything spent collecting immature cones is a total loss. Dates of cone ripening vary so much (table 7) that a specific test for cone maturity is needed to time the beginning of collection in any one place and season. Large-scale application has proved flotation in certain oils to be a heder test than cone color, appearance of seed in cut cones, or flotation of cones in water.

The dependability of the oil-flotation test results from the decrease in specific gravity which always accompanies the final maturing of cones (p. 30). Although southern pine cones picked while their specific gravity is between 1.00 and 0.89 (that is, while the cones barely float in water) may mature after picking and eventually open, it is best to wait until the specific gravity has dropped below 0.89 (table 8). The easiest way to determine whether the specific gravity of cones is above or below 0.89 is to see whether they sink or float in a liquid with that specific gravity (fig. 13). Collection should not be delayed after the cones begin to float in the appropriate liquid, because when their specific



F-465224

FIGURE 13.—Longleaf pine cone floating in SAE 20 lubricating oil within 10 minutes after having been picked from the tree, and therefore mature enough to open and release its seeds when dried.

TALE 7.—Usual dates of maturity, collection, and natural opening of southern pine cones¹

Species	Maturity	Collection	Opening on trees
Slash	Sept. 1 to 10	Sept. 1 to 20	Sept. 20 to 30.
Loblolly	Sept. 20 to Oct. 10.	Oct. 1 to 20 ²	Oct. 10 to 30. ²
Longleaf	Oct. 1 to 20	do	Oct. 20 to Nov. 10.
Shortleaf	do	Oct. 11 to 30	Nov. 1.

¹ Based largely on observations from Georgia and Florida to Texas.

² Occasionally a week to 10 days later, especially when rainy weather delays opening.

TABLE 8.—Relation of yield of seed per bushel of unopened longleaf and loblolly pine cones to specific gravity of cones when picked

Species, and method of extraction	Yield ¹ of seed per bushel of cones having a specific gravity of—			
	1.00 or more ²	0.99 to 0.89 ³	0.88 to 0.80 ⁴	0.79 or less ⁵
Longleaf:				
Immediate kiln drying at 120° F. without precurring	Pounds 0	Pounds 0	Pounds 1.2	Pounds 1.7
Drying at natural air temperature	.2	.2	1.3	1.7
Kiln drying at 120° F. after 2 weeks' precurring at air temperature	.2	.3	1.2	1.9
Loblolly:				
Immediate kiln drying at 120° F. without precurring	.0	.3	1.3	1.2
Drying at natural air temperature	.1	.6	1.3	1.4
Kiln drying at 120° F. after 2 weeks' precurring at air temperature	.1	.7	1.5	1.4

¹ Each value calculated from yield of 100 cones. The study included 20 longleaf and 20 loblolly trees, each of which contributed 5 cones to each 100-cone lot.

² Cones sank in water.

³ Cones floated in water but sank in SAE 20 lubricating oil.

⁴ Cones floated in SAE 20 oil but sank in kerosene.

⁵ Cones floated in kerosene.

gravity drops to about 0.70 they start to open on the trees.

Lubricating oils of grade SAE 20, if stated by their manufacturers to have specific gravities of about 0.88, may be used as test liquids, as may a mixture (473) of 1 part of kerosene to 4 parts of raw linseed oil. Only 2 or 3 quarts of oil, a container large enough to let the cones float without touching the sides and having a cover to keep the oil from slopping out in transit, and an ice pick

for fishing out cones that sink, are needed for the test.

The crop is mature enough for safe collection whenever sound, freshly picked cones from 19 out of 20 random sample trees will float in the oil. *The test should be made within 10 minutes after the cones have been removed from the tree, because 1 or 2 hours drying between picking and testing may enable hopelessly immature cones to float.* Wormy, deformed, or otherwise visibly abnormal cones are useless for the test, as are cones from trees that have been felled for more than a few hours.

If the cone quota does not require collecting throughout the season, it is better to concentrate collection toward the end than toward the beginning. Late collection prevents getting immature cones and reduces shipping weights and spoilage. At first maturity, cones weigh about 33 to 35 pounds per bushel; just before opening, about 20 to 25. The loss of 8 to 15 pounds of moisture per bushel while the cones are on the trees correspondingly reduces extracting time and costs. There is also scattered but consistent evidence (68, 398, 473) that the later seed is collected the better it germinates. Late-collected seed probably also stands storage better. The ideal time to collect small lots of cones from abundant crops is when the first cones on a few trees have just started to open; under these circumstances the oil test is unnecessary.

Details of Collection

To avoid legal difficulties, anyone collecting on land other than his own should obtain the owner's written consent before starting to collect.

Before collecting cones inside a white-fringed beetle quarantine line and shipping them across it, the collector should get clearance from the U. S. Bureau of Entomology and Plant Quarantine and the State entomologist or plant board. To insure freedom from the beetles, the cones should be kept out of contact with the ground while awaiting shipment.

Collection of cones from felled trees should be confined strictly to trees cut after the cones have matured (69). The risk of getting immature cones from trees cut before cone maturity is too great, even though nearly mature loblolly and shortleaf cones sometimes finish ripening on crowns on the ground. Immature slash and especially longleaf cones seldom finish ripening after logging, because most of them fall off when the crowns hit the ground.

Collectible cones are those that can be found, reached, and picked or gathered fast enough to keep labor costs within reasonable bounds. Practically all sound, unopened cones from trees felled after cone maturity are collectible. When collection is by climbing, some cones at the ends of long branches or on very large or high-crowned trees cannot be reached. Some trees bear too few ac-

cessible cones to repay the cost of climbing. Only when climbers are very expert or seed is urgently needed does it pay to climb small longleaf or slash pine trees bearing less than 20 cones apiece, or large trees bearing less than 40 or 50 within reach of 8- to 15-foot collecting poles. Somewhat larger numbers are required to justify climbing loblolly and shortleaf, because their cones are much harder to detach, especially with cone hooks or poles, and they average fewer seeds per cone.

Rejecting the smaller cones during collection is not recommended, even if it can be done without extra cost. Although seedlings from the larger seeds characteristic of the larger cones tend at first to outgrow other seedlings in the nursery, the advantage usually is temporary, and seedlings from small seeds are as likely as those from large seeds to inherit desirable hardiness, growth rate, form, and resistance to insects and disease (155, 503, 507, 518, 568, 597, 644, 687).

On the other hand, rejecting cones from poor trees in favor of those from trees of superior form, growth rate, and resistance to insects and disease merits consideration. Many authors advocate such collection, some to the extent of establishing "seed orchards" of superior trees (69, 90, 155, 427, 503, 507, 619, 639). Some improvement in the heredity of plantations from seed selected in these ways is almost certain. Whether planted pines will benefit substantially is problematical. The known reproductive processes and apparent genetical make-up of pines indicate that the benefits may be small.²¹ There is little evidence that selecting southern pine cones from superior trees or stands measurably improves plantations. Until more evidence becomes available from experiments, it is recommended that collection from superior trees be favored to the extent possible without extra cost.

Methods and Equipment

Where fresh cones are not available from logging operations, it is necessary to climb standing trees. Collection by climbing may seriously reduce the following year's and later crops through destruction of yearling cones or breaking off of bearing twigs (427). Such injuries to trees should be kept at a minimum by training and supervising the crews.

Cone hooks on light peles are essential to efficient collection from standing trees, especially longleaf and slash pines. They should be adapted to both pushing and pulling (fig. 14) (718, p. 114). On small trees many cones are most efficiently reached from the ground with 15- to 20- or even 30-foot peles. In climbing, peles about 8 feet long, with looped thongs at the handle ends, are most convenient, but a few 15-foot peles should be available for wide-crowned trees.

²¹ Because pines are cross-pollinated and apparently highly heterozygous (697).



E-ARRA7R ARR095

FIGURE 14.—A, Collecting longleaf pine cones by climbing. B, Closeup of S-shaped cone hook. Many cones are more easily detached by pushing (with the other side of the hook) than by pulling.

Climbing for cones is dangerous. Safety belts should be required. All climbing equipment should be of excellent quality and should be scrupulously inspected at least once a day. Foremen should rigorously discourage recklessness and horseplay. Cone hooks should never be hung on branches above the climber, lest they slip, off and cut him as they fall. Cones should never be gathered from the ground while climbers are still in the tree above.

Leather or leather-palmed gloves are needed for handling loblolly, longleaf, and slash pine cones.

It is more efficient to gather cones into bushel baskets and empty the baskets into 1-bushel or 2-bushel sacks, than to gather cones directly in loose sacks. The baskets save time, permit closer inspection during gathering than do sacks, and simplify tallying the total amount collected. A portable rack on which sacks can be hung, with mouths distended, saves much time in emptying baskets into sacks.

Ordinarily, no visibly wormy cones should be gathered. they yield only one-half to one-third as much seed as sound cones, and break up into fragments almost impossible to remove from the seed.

While they are being gathered, cones should be completely freed from pine needles and grass. Such trash cannot be eliminated as cheaply at any other stage of handling. Needles especially, if run through the extractory, break into short pieces exceedingly hard to remove from the seed.

Sacks should be closed with string, not wire. Bits of cut wire mixed with the cones are a prolific source of damage to dewingers and fanning milis.

Labeling

Because of the importance of recording seed source, a stout cardboard or cloth tag showing species, place, county, State, and collection date should be attached to each sack of cones before it

leaves the collecting ground. Such labeling is particularly necessary if more than one lot of each species is going to the same extractory.

Care Between Collection and Extraction

If cones are kept in sacks or in deep piles or bins for many days early in the collecting season, they are likely to mold, heat, or ferment. If they are similarly mistreated late in the season, prevention by lack of space at the start may make normal opening impossible later on, with consequent loss of seed. Cones should, therefore, not be left in sacks more than a week or 10 days at the most. Preferably they should be spread in curing sheds or on extracting racks or trays within 3 or 4 days of collection; and the necessary space and equipment should always be provided before collection starts. The importance of such spreading cannot be emphasized too strongly.

A wetting right after collection may not harm cones, but it is safer to protect them from rain. Free circulation of air through the piles or around each sack will prevent heating and reduce not only molding but also shipping weight and the length of time needed for extraction.

EXTRACTION

Since thorough drying normally suffices to open cones of the four principal southern pines, extraction is mainly a matter of reducing cone moisture content till the cones open, then shaking out the seed. The exact moisture content required for cone opening has not been worked out in detail. Combinations of temperature and relative humidity that will bring wood to 4 percent moisture content (such as have been published as guides for kiln-drying lumber) appear, however, to be generally effective with southern pine cones (594, 596). Practical means of extracting seed mechanically, without drying, such as have been reported for ponderosa pine (501), have not been developed for the southern pines.

Avoiding Injuries to Cones and Seed

Consistently successful extraction requires: (a) Protection of cones from rain; (b) continuous free access of air to all cones except for brief, unavoidable storage and transportation in sacks; (c) exclusion of rodents and birds; and (d) as prompt extraction of seed as the condition of the cones will permit. Without these safeguards, decreases in the quantity or quality of the seed extracted are almost inevitable.

Mold, heating, or fermentation, or pressure on the scales as they start to separate, may keep even mature cones from releasing all their seed. The first three of these forms of injury may also reduce the viability of the extracted seed.

Insects in wormy cones overlooked during collection, especially the larvae of moths (*Dioryctria*

spp.) in longleaf cones, may continue to feed in the extractory and consume appreciable quantities of seed unless they are destroyed by prompt kiln-drying of the cones. Rodents and birds are likely to take much seed from partly opened cones if they can reach it.

High or fluctuating seed moisture content between collection and extraction or storage (even for very brief periods and especially if accompanied by exposure to moderate or high air temperature) may prevent successful storage even if it does not immediately reduce germinability (86, 87, 174). In a test in 1941-42, germination of longleaf seed left in well-spread cones in a standard U. S. Forest Service cone shed decreased 8 percent between January 14 and February 11, and 18 percent between January 14 and March 31, compared with that of seed extracted January 14 and stored at 40° F.

Too slow drying in cool, shaded places appears to decrease the yield of seed from some lots of fully mature southern pine cones, as it does with ponderosa pine (473). The remedy is increased ventilation, exposure to direct sunlight, or kiln-drying.

Precurring of Cones

Cones which have been collected when nearly mature (specific gravity approximately 1.0) may be made to finish ripening after collection. Bringing such cones to complete ripeness, especially for kiln extraction, is one phase of *precurring*. It usually takes 2 weeks or a little more. It often greatly improves the yield, and probably also the quality, of seed collected early in the season. (Among the cones in the 0.99 to 0.89 specific gravity class in table 8, this type of precurring accounts for the better seed yields from treatments other than immediate kiln-drying.) Precurring is best carried out by spreading the cones in layers two to six cones deep, preferably on wire screens, in the shade, and with free but not excessive air circulation. Deeper piling of immature cones, or keeping them in sacks, makes them mold, heat, or ferment and prevents final ripening. Too rapid drying in excessive drafts or in direct sunlight, or immediate kiln-drying, also prevents final ripening.

The other phase of precurring consists of temporary storage of fully mature but still fairly moist cones (specific gravity only slightly below 0.89) in layers six to eight cones deep. Such precurring prevents molding and gets rid of easily removed moisture with minimum tray or floor space. It shortens the period required for later complete drying at artificial or air temperature. Although it involves rehandling, it is often essential to efficient extraction of large shipments of cones. It is, however, only a temporary expedient, good for 2 or 3 weeks at most, and not effective for complete drying at natural air temperatures.

Extractory Design and Equipment

Extractories function effectively only when designed in accordance with the weights of cones on arrival, the amounts of water to be removed, the volumes of cones both before and after drying, and the sizes of individual cones and seed.

A space 10 by 10 by 8 feet will hold about 11 tons of newly matured cones piled in bulk, and perhaps 10 tons in sacks. After they open, cones take up 2 to 3.5 times the space they occupy when closed. The writer has seen an extractory floor collapse under the weight of green cones, and roofs lifted off by drying ones, from disregard of these facts.

The amount of water to be removed—from 6 to 17 or more pounds per bushel of unopened cones—governs the heat and airflow requirements of cone kilns, and the requirements for ventilation in extraction at air temperature.

Of particular importance in designing trays, racks, cone kilns, and the general layout of extractories are the areas required to spread cones in single layers and the clearances required between trays or racks.

For final drying cones should never be spread in layers more than two cones deep, even in air-temperature extraction on, wire shelves or trays. In kilns, or in air extraction on tight floors, they should never be spread in layers more than, one cone deep. Any apparent saving of space or of investment in equipment made by using deeper layers is false economy.

The smaller the cones, the greater the area covered by a given volume spread in a layer one cone deep. The square feet required per bushel when so spread are, roughly : Longleaf pine, 8; slash, 10; loblolly, 15; and shortleaf, 20. Exceptionally large cones may save 20 percent of the area ordinarily needed for the species—not more. Cones smaller than average require extra area per bushel (p. 198).

Cone trays, racks, or shelves should clear each other by at least the maximum length of the cone of the species to be extracted (p. 198) or twice the diameter of the cone when open, whichever is greater. Minimum practical clearances of trays or racks are from 3 to 4 inches for shortleaf pine to 8 to 10 inches for longleaf. If equipment is to be used for two or more species, clearances must fit the largest cones or be made adjustable (596, pp. 4 and 6). The clearance of wide, fixed shelves to be loaded and emptied by hand or with rakes or brushes, and of any shelves to be used for precuring, should be much greater, usually 16 to 18 inches, to allow both working space and free air movement.

Wire used for cone shelves or trays must be either fine enough to stop the smallest seed with the wing off ($\frac{1}{18}$ -inch mesh screen wire suffices for the southern pines) or coarse enough to pass the largest seed with the wing still attached (p. 198). The larger is generally preferred ; $\frac{1}{2}$ - or $\frac{5}{8}$ -inch square mesh meets most requirements,

although $\frac{1}{3}$ -inch mesh may be necessary to prevent the passage of small unopened shortleaf ones. Intermediate meshes that will neither pass individual seeds nor let them be brushed off easily are an unmitigated nuisance.

Air-Temperature Versus Kiln Extraction

The certainty that the seed will not be injured by artificial heat is one of the greatest advantages of air-drying over kiln-drying. Others are : relatively simple and inexpensive equipment;; simpler technique ; greater economy when the extractory is operating below full capacity ; and less danger of fire.

Kiln extraction is, however, quicker than air extraction, especially in humid or rainy seasons. It reduces exposure of the seed to birds, rodents, insects, and physiological deterioration. Kiln-drying requires less shed or tray space for large quantities of seed, because many cones go to the kiln from precuring racks, in which they have been spread 6 to 8 cones deep instead of in single layers. At the end of the collecting season they may go to the kiln directly from sacks. Kiln extraction often gives slightly better yields per bushel than air-drying and in most of the southern pine region reduces seed to more nearly the right moisture content for storage.

Single layers of cones on floors and double layers on wire-bottomed shelves or trays dry out and open about equally well. Where floors tight enough to hold seed and smooth enough to permit sweeping it up are available during the extracting season, their use saves building special equipment. Otherwise tiers of shelves or of movable trays give the freest circulation of air among the most cones with the smallest investment in walls and roof. The tiers may be installed in existing buildings or housed in special sheds. Cone sheds (fig. 15) are usually about 18 by 80 feet, with five 6- by 80-foot shelves, 16 inches one above another, on each side of a 6-foot aisle. At full loading, including that of movable trays bridging the aisle at all shelf levels, and of the floor, such a shed holds about 1,060 bushels of longleaf cones, 850 of slash, 570 of loblolly, or 420 of shortleaf, spread one layer deep. For temporary storage or precuring, total capacities are three or four times these amounts. Blueprints and a bill of materials for a cone shed may be obtained from the Regional Forester, U. S. Forest Service, Atlanta, Ga.

Kiln Extraction

To be effective, a cone kiln must supply enough hot air to dry the cones quickly—usually in less than a day ; circulate the hot air freely and rapidly among all the cones in the kiln; keep temperature and humidity below levels injurious to the seed ; and permit adjustment of temperature and humidity schedules to meet the requirements of different batches of cones.

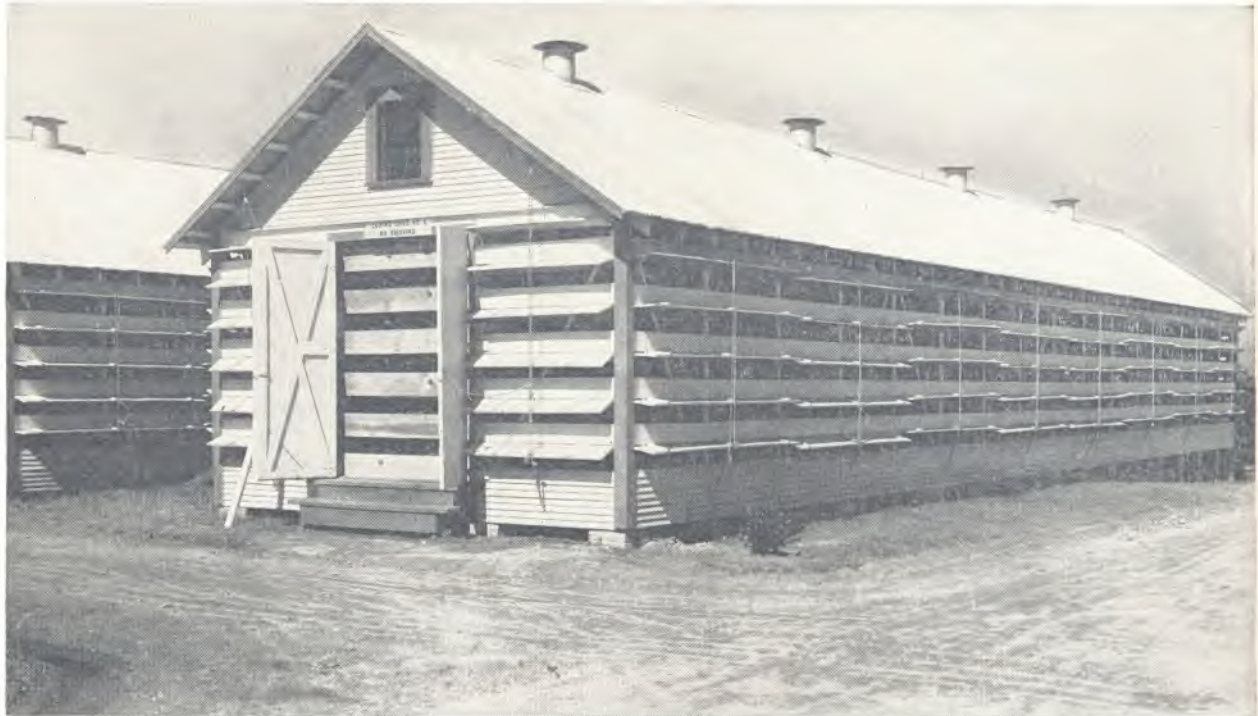

F-310759

FIGURE 15.—Type of cone shed used by Region 8 of the U. S. Forest Service and by several southern States.

The volume of hot air needed and the heater capacity required to supply it can be calculated from maximum safe temperature, cubic feet of kiln space, maximum pounds of water to be evaporated per charge of cones, rate of air discharge, and related data. Most of these values vary considerably from one kiln to another. As a rough general rule, however, a heater which will bring the air in the loaded kiln to maximum safe temperature in about 1 hour, and keep it there without difficulty, is big enough.

Rapid circulation of the air in contact with every cone serves two important purposes. One is to get all the cones dry and open as quickly as possible and at about the same time. The other is to keep the temperature of the seeds safely below that of the air in the kiln while the seeds are still moist, as they are in unopened cones freshly placed in the kiln. Seeds are most easily injured by high temperatures when they are that moist. As long as air movement is rapid, however, moist cones and the seeds they contain cannot become as hot as the kiln air, because they are cooled by evaporation from the cone surfaces. If, on the other hand, the air moves sluggishly, evaporation slows or ceases and the moist cones and seeds become as hot as the kiln air. Under such conditions, ordinarily safe kiln air temperatures may injure the seeds, and slightly higher temperatures may kill them outright.

Air movement in kilns can be tested with fumes of titanium tetrachloride (used for skywriting with airplanes), or by means of talcum powder.

Because of the fine hazard, tobacco smoke, joss sticks, and the like are not recommended. The fumes or powder should move briskly in all parts of the kiln; any sluggish movement or dead air calls for adjustment of loading, vents, baffles, fans, or temperatures.

The U. S. Forest Service has used two types of forced-draft kilns, with optimum capacities of about 35 bushels of shortleaf cones and 135 bushels of longleaf cones, respectively, per charge. These kilns, which have proved much more satisfactory than convection-type kilns for drying large quantities of southern pine cones, extract seed without injury in 4 to 16 hours (usually in 8 to 10 hours), at costs ranging from 12 to 65 cents per pound of seed (usually about 25 cents), including depreciation of the kilns. Rietz has described in detail the design, operation, and performance of both these types of forced-draft kilns (596).

The one great disadvantage of such forced-draft kilns is their high initial cost, which only a fairly heavy and regular annual extracting load may justify. For small or irregular annual extractions by artificial heat, less expensive convection-type kilns may be preferable.

Air-movement in convection kilns depends almost entirely on the tendency of warm air to rise vertically and of cool air to sink; sidewise movement of air usually is negligible. The greater the contrast in temperature between the cold air outside a convection kiln and the artificially heated air inside, the brisker the air movement. For this reason, such kilns work better in November, when

loblolly and longleaf cones become ready for kiln-drying, than in September, when slash cones need drying. The air also moves more briskly the higher the vertical channel or flue through which it rises or sinks. But at best the air in convection kilns moves with little force, and is inevitably slowed or stopped if layers of cones are too thick or too many.

Air heated to safe maximum temperatures will rise among and successfully dry out cones on six or possibly eight wire screens inside a square, tight-walled flue not more than 5 by 5 or 6 by 6 feet in cross section. The wire screens, which are easiest to load and unload if each consists of two removable trays, should be at least 12 to 18 inches apart, one above another. The higher (up to at least 8 or 10 feet) that the walls of the flue extend above the topmost tray, the more completely open the top of the flue, and the more freely the hot air can escape outdoors from the top of the flue, the faster the hot air inside the flue will rise past the cones and dry them out. One or a battery of such flues can be constructed in any suitable high-roofed building or shed. Each flue should have its own abundant supply of hot air, preferably from a steam pipe or coil. A baffle may be needed beneath the lowest screen in each flue, to make the hot air rise uniformly through all parts of the cross section of the flue.

Where low ceilings, difficulty in supplying hot air separately to each flue, or need for greater capacity makes impossible the type of kiln just described, downward air currents around the walls of a room 15 by 15 to 20 by 20 feet may be used to dry cones. The requirements for effective drying in this way are : (1) A steam radiator or other source of heat in the middle of the room ; (2) a flat, tight, fairly low ceiling; (3) tiers of wire-bottomed cone trays around all sides of the room with 8 to at most 12 trays per tier; and (4) generous vents all around the bottom of the room walls to drain off all the air descending through the cone trays.

When the kiln is in operation, hot, dry air rises from the heater, hits the ceiling, and spreads outward toward the walls. As it reaches the cones in the topmost trays, it absorbs water from them and starts to cool. As it cools, the air settles through the trays, drying the cones and becoming still cooler as it goes, and finally escapes through the vents in the walls below the lowest trays. Canvas screens, parallel to the ceiling and extending from the inner edges of the topmost trays almost to the middle of the room above the heater, and canvas or wooden baffles extending from the bottom trays to the floor on the sides next to the heater, may be necessary to keep the air circulating through the trays of cones.

In a kiln using either upward or downward convection currents, the cold air intake leading to the heater, or the heater itself, must be below the floor. There must be no openings or channels through which the hot air can escape more easily than by

passing through the trays of cones. And to permit easy passage of the air through the trays, it is imperative that the cones be spread in uncrowded single layers.

Although a few cone kilns in the South have utilized convection currents well enough to dry cones thoroughly and uniformly in 12 to 48 hours, other defects in design have made them excessively expensive to fill and empty. Numerous other convection kilns have failed because fundamental defects in design have made drying slow or uneven, or have injured the seed through overheating. There is need (72) for proved designs for efficient, reliable, homemade convection kilns capable of drying 20 to 50 bushels of southern pine cones in 8 to 12 hours. Such kilns should greatly facilitate procurement of good local seed, especially in poor crop years when it is important to get maximum yields per bushel by kiln-drying all cones.

It increases the efficiency of any kiln to construct it on a side hill, or with a ramp, so that cones can be unloaded from trucks onto the floor above the heater without lifting, be dried there, and be fed by gravity into the tumbler.

Since hot, dry, resinous, open cones are almost explosively flammable, steam coils or radiators are far safer for any kiln than are stoves or hot-air furnaces. Oil-burning furnaces, automatically controlled, maintain the steadiest heat; coal furnaces are next best. Wood-burning heaters require considerable labor and close attention for satisfactory performance.

Efficient operation of any type of kiln demands at least a partial and preferably a complete extra set of trays, to be filled and ready for immediate insertion when a charge is removed.

Designing a kiln to insure adequate amounts and circulation of hot air is only half the story. To get the seed out of the cones without injury, it is necessary also to keep kiln temperatures and humidities safely below the highest levels the seed will stand. To get the seed out economically, temperatures and humidities must be combined in schedules that will dry and open the cones in brief, convenient periods without using excessive fuel. Neither safe levels nor economical schedules can be maintained without knowing and controlling kiln temperatures and humidities throughout each run.

To avoid overheating any seed, kiln temperatures are measured at a point as close as possible to the place where the incoming hot air first hits the cones. In a forced-draft kiln this usually is high on the wall opposite the air inlet. In a kiln utilizing upward convection currents it is under the lowest screen. In one utilizing downward convection currents it is above one of the topmost trays. No kiln should be without a direct reading and preferably also a maximum thermometer at the point described, the former to guide the operation of the kiln and the latter to show that the maximum permissible temperature has not been

exceeded at any time during the run. A recording hygrothermograph at the hottest point is essential to safe, efficient operation of a forced-draft kiln.

In any type of kiln, relative humidity usually is measured at the same point as temperature, to show whether the ingoing air is at the right combination of temperature and humidity (p. 36) ultimately to open the cones. It is useful also to measure relative humidity where the coolest, wettest air leaves the kiln, to make sure the air is removing moisture rapidly from the cones. If it is not, the temperature of entering air, the air circulation, or the loading or arrangement of the trays should be adjusted so that it does.

As a general rule, longleaf seed should be extracted at a maximum entering air temperature of 115° F. and loblolly, slash, and shortleaf at a maximum of 120°. Occasionally, longleaf has been extracted at 120° to 130°, loblolly and slash at 130°, and shortleaf at 140°, without excessive injury, but these temperatures are not recommended. They should not be necessary to open mature, properly cured cones in well-designed, well-operated kilns. In one kiln, each 5° increase in kiln temperature between 115° and 135° caused a consistent decrease of 5.6 plantable seedlings per 100 longleaf seeds sown (596). Safe temperature limits for any species vary considerably with kiln design, loading and operation, duration of kiln run, and moisture content of the cones at the beginning of the run. Exact limits under the conditions most commonly encountered in a particular kiln can best be determined by opening several kiln-loads of cones at different temperatures and testing the germination of the seed from each load.

Although the exact humidity limits within which injury occurs have not been determined, it is known that prolonged high relative humidity in the kiln injures the seed. Simultaneous high temperature increases such injury. By contrast, the lowest humidities attainable under southern climatic conditions in kilns operated at maximum safe temperatures apparently do not injure southern pine seed within the periods needed to dry the cones. For these reasons, the safest rule is to run the kiln at all times at the lowest humidity attainable without wasting fuel. For an hour or more at the start of a run, the humidity cannot be brought as low as it can later. Moderately high humidity is least dangerous at the start of the run, however, because the rapid evaporation which keeps the humidity up also cools the cones and keeps the temperature of the seed many degrees below that of the kiln air. Keeping humidity as low as possible at all stages of drying not only safeguards the seed but expedites opening and removal of the cones. Within the limits set by weather conditions, kiln design, and maximum permissible kiln temperature, humidity is decreased mainly by increasing the rate at which the moist hot air is allowed to escape from the kiln through manually operated vents.

Since seed injury at any temperature is likely to increase with duration of exposure (594, 595, 596), seed should be removed from the kiln as soon as possible after the cones have opened completely.

Tumbling of Cones

Although fully dried cones shed most of their seed on drying floors or shelves or where they are emptied out of movable trays, they almost invariably have to be tumbled in a box or drum to get all the seed out.

For large quantities of cones, a progressive tumbler driven at 27 to 30 r. p. m. on a horizontal shaft by a 1½- or 2-horsepower motor is highly efficient. It should be 10 feet long, 3 feet square at the small end, and 4 feet square at the large end (fig. 16). The sides should be covered with ¾-inch square mesh manganese steel wire (⅓-inch for a tumbler used for shortleaf only), as ordinary hardware cloth lasts only a few hours in a tumbler of this capacity. Cones fed into the tumbler through a chute at the small end drop their seeds through the mesh into a catch tray as the tumbler revolves, and move to and discharge through the large end by gravity. For tumbling small lots of cones, a similar progressive tumbler 6 feet long, 3½ by 3½ feet at the small end, 4 by 4 feet at the large end, covered with ½-inch mesh hardware cloth, and turned by hand, is far more efficient than batch-type tumblers which require hand loading and unloading of each charge.

For maximum seed yields, cones must be tumbled either on dry days or immediately after removal from the kiln. The relative humidity in the South is usually high enough to cause cone scales to close slightly and retain an appreciable portion of the seed.

Cones should be examined carefully after tumbling, and occasional samples redried at maximum permissible temperatures and retumbled, to make sure that extraction is complete. On a large job this precaution may save hundreds of dollars worth of seed (242).

Disposal of Cones

Open cones are so bulky that they must be disposed of currently. They make an undesirably hot, irregular fire for kiln furnaces, and are among the poorest of organic remains for nursery composts. At most extractories, therefore, they are incinerated. Incineration involves serious fire hazards unless at a considerable distance from buildings and in a burner with spark arrester. The belt conveying cones to the burner must be installed in a way to prevent its carrying fire back to the extractory.

The use of cone ashes for fertilizer or as an amendment to compost has not been adequately tested.

Cones not badly broken during tumbling may often be sold to novelty manufacturing companies.



FIGURE 16.—Interior of power-driven progressive cone tumbler, viewed from large end. For specifications write Regional Forester, U. S. Forest Service, Atlanta, Ga. (Photo courtesy of Louisiana Forestry Commission.)

DEWINGING, CLEANING, AND DRYING

Practically all pine seed is dewinged and cleaned to reduce shipping weight, storage weight and space, and outlay for containers, and to make the seed easier to mix, sample, test, package, sell, and sow. Dewinging and cleaning usually reduce weight by at least 15 percent, and may reduce it by 50 percent. They reduce volume even more than weight.

Many lots of southern pine seed, both air-extracted and kiln-extracted, come from the cones at moisture contents too high—sometimes by 5 to 25

percent—for safe storage over long periods. Unless they are to be sown immediately or stored for short periods only, such lots, and also those which have absorbed excessive moisture from the air after extraction, require artificial drying to about 10 percent moisture content (p. 46) based on oven-dry weight.²² Seed lots at the highest moisture con-

²² Basing moisture content percent on oven-dry instead of on "wet" weight of seed simplifies calculations of weights to which seed must be dried for storage (p. 216). It also permits direct comparison of behavior of seed lots dried to different moisture contents (p. 47). All seed moisture content percentages in this publication are calculated in terms of oven-dry weight as described on p. 61.

tents cannot even be dewinged by the usual methods without first being dried.

Dewinging, cleaning, and drying usually are carried out in that order, immediately after the seed has been removed from the cones, and are guided by tests (pp. 57-65) of samples drawn during each process. Occasionally, however, very moist seed is dried before dewinging, or final dewinging and cleaning are postponed until after storage (p. 53) or stratification (p. 54).

There is less technical information about seed dewinging and drying than about any other phase of processing southern pine seed. It is known, however, that 30 percent or more of the seeds in some large, commercially dewinged lots have been injured mechanically during dewinging, and that many tons of seed have had their germination percent reduced by one-fourth to three-fourths or more by insufficient or faulty drying. Since such injuries seriously increase the cost of nursery stock by decreasing tree percent (fig. 11), tracing and eliminating them gives the collector or nurseryman one of his best opportunities to reduce costs.

Dewinging

The seed wings of all the southern pines except longleaf can be rubbed or broken cleanly from the dry seeds. No way of completely dewinging longleaf seed in bulk has been discovered; commercial "dewinging" merely reduces the wings to stubs. This reduction, however, saves much space, enables the seed to pass through mechanical seeders, and keeps it from blowing about during sowing. The drier the seeds of longleaf pine or other species, the easier the wings are to reduce or remove by ordinary methods.

Hand rubbing, though slow, is frequently the most economical method of dewinging small lots of seed. Some extractory operators prefer it even for large lots. Of all methods, it is least likely to injure the seed. For reason of economy, however, most extractory operators prefer to use mechanical dewingers. The continuous-feed dewinger used by Region 8 of the U. S. Forest Service (p. 215) is driven at about 90 revolutions per minute by a 1-horsepower motor, and has a capacity of 30 to perhaps 70 pounds of seed per hour, depending on species and cleanness.

To operate mechanical dewingers at full capacity without injuring the seed requires great care. The brushes must usually be of fiber instead of wire, and neither too soft to be effective nor so stiff as to crack the seed coats, especially of longleaf pine. They must be readjusted frequently to offset wear, and replaced before the bristles become so short as to lose their springiness. Care is also necessary in adjusting revolutions per minute and rate of feed. In some cases, the seed must be dried artificially before mechanical dewinging. Optimum adjustment and procedure must be determined and maintained for

each dewinger and species by trial runs and by frequent close examinations of the seed (preferably with a hand lens), and also (242) by periodic germination tests of samples of dewinged seed (pp. 57 and 61), made while cleaning is still in progress, to reveal serious internal injuries to the seeds from too rapid revolution of the dewinger.

When the wing of a seed of any southern pine except longleaf is thoroughly moistened, the two curved prongs which attach the wing to the seed straighten out within a few seconds and the seed falls away at a touch. Advantage is sometimes taken of this fact in dewinging species other than longleaf. Either (1) the hands are dipped repeatedly in water during dewinging by hand rubbing; (2) the seed is spread on screens in layers about an inch deep, hosed until thoroughly moist, and stirred repeatedly until dry; or (3) before dewinging, the seed is chilled in contact with moist peat (to accelerate germination, p. 54) and the loosened wings are removed with the peat.

Except with longleaf pine, these wetting methods frequently are cheaper than mechanical dewinging of dry seed. Their disadvantage is that they usually increase seed moisture content enough to cause deterioration or spoilage. The third method also necessitates a special calculation of sowing rates (p. 75). If seed dewinged by wetting cannot be sown or thoroughly redried the same day it is wet, it should be stored overnight at 35° to 41° F., and sown or redried the next day.

From the scanty evidence available (672), hammermills, because of their tendency to scarify the seedcoats, cannot be recommended for dewinging southern pine seed.

Cleaning

The percentages of purity and soundness in table 9 are suggested standards for cleaning seed. They meet the needs of economical shipment and storage, reputable marketing, reliable sampling for testing, and good control of sowing rate. They have been attained with stock model or locally modified commercial cleaning mills, without excessive cost in labor or in loss of sound seed, though usually they have required two runs through the mill, and sometimes three.

As a preliminary to final cleaning, seed that has been hand-rubbed (or moistened, stirred, and dried) can be separated from the wings by placing it on a light, wire-bottomed tray, holding the tray shoulder high, and then lowering the tray quickly and swinging it to one side. The wings remain suspended in the air for a moment and then flutter clear of the tray. Such elimination of the wings increases the speed and exactness of later steps in the process of separating sound seed from empty seed and impurities.

TABLE 9.—Suggested minimum desirable and maximum feasible standards for cleaning southern pine seed in oscillating-screen, vertical-air-blast mills

Condition and species	Purity percent ¹		Percentage of full seed ²	
	Minimum	Maximum	Minimum	Maximum
Wings intact, longleaf	90	95	85	90
Wings reduced to stubs, longleaf	90	95	90	95
Completely dewinged:				
Slash	95	99	95	98
Loblolly	95	99	85	90
Shortleaf	95	98	95	98

¹ Weight of externally normal-looking, nonwormy, unbroken seed divided by total weight of all seed plus impurities, and multiplied by 100.

² Total number of seeds with kernels (determined by cutting test) divided by total number of externally normal-looking, nonwormy, unbroken seeds, and multiplied by 100.

The most efficient and uniform final cleaning requires a seed mill with two or more oscillating screens to separate seeds from larger and smaller impurities, and an adjustable upward air blast to separate light impurities and empty seeds from full seeds. The mill must have interchangeable screens for seed of various sizes; screen slope and the distance and speed of screen movement may also be adjustable (725). Even such mills, however, clean longleaf seed with the wings on less well than that with wings reduced, and dewinged loblolly less well than dewinged slash or shortleaf seed, because the contrast between the weights of full and empty seeds is less (226) (table 9). Moreover, they clean pine seed less rapidly than most agricultural seed, and at rates varying greatly with the state of the seed. The capacities per hour of power models commonly used range from perhaps 30 to 150 pounds of longleaf seed to a maximum of 450 pounds of the other pine species.

The most effective screen sizes,²³ operating speeds, and rates of feed must be worked out locally by frequent sample weighings and cutting tests (pp. 59 and 60). Too fast a feed must be avoided particularly. Fanning out more than 1 to 5 percent of all sound seeds usually necessitates refanning the accompanying trash to recover them.

Fanning seed is dusty work. Respirators frequently are necessary to workers' comfort and health. The fire and explosion hazard makes explosion-proof preferable to ordinary motors, and there must be no smoking. When much seed is to

²³ Table 27 on p. 198 is useful in selecting sets of screens for seed mills.

be cleaned indoors, some dust-disposal system may be necessary.

Although good seed mills may be used to grade seed according to size as well as for cleaning, and such grading may make the resulting nursery stock more uniform in size, there seems little justification for separating seeds by size classes (155, 243, 247, 503, 507, 518, 568, 590, 597, 644, 687). The principal effect would be to separate the seed of young from that of old trees (p. 31).

Southern pine seed—even longleaf with the wings on—can be separated fairly well from wing fragments and other light impurities by pouring it slowly from one container to another in a strong wind, or by dribbling it down a sloping screen over an uptilted electric fan. Since neither method gets out cone scales or many empty seeds, both are unsatisfactory for cleaning seed from wormy or badly broken cones, or that contains a large percentage of empties.

Most filled, completely dewinged seeds of loblolly, slash, and shortleaf pines sink in water; most impurities and empty seeds float. With these species, seed averaging 97 to 100 percent full can therefore be obtained by flotation (461). But cleaning by flotation increases the moisture content of the seed—a serious drawback except with seed chilled in a moist medium before dewinging (p. 54). It results also in losing some full seeds which fail to sink—usually at least 10 percent, and more if the seed is very dry or if many wing stubs still adhere. Flotation is useless for cleaning longleaf seed, which floats even when full and cleanly dewinged.

Drying

Seed is often undesirably moist (p. 46). The best method for drying it depends primarily on extraction method, drying and storage facilities, current weather, and the extent to which moisture content must be reduced. In some instances, facilities for testing moisture content may affect choice of method.

When the seed coming from a cone kiln is found to be too moist, later batches often can be dried satisfactorily in the same kiln by precuring the cones more thoroughly, by loading the kiln less heavily, or by changing the kiln schedule. In modifying the schedule, the kiln temperature may be increased, the relative humidity reduced, or the run lengthened. The first and last of these three changes must be made cautiously to avoid injuring the seed. Although all three will increase fuel consumption, the resulting reduction in seed moisture content should more than offset the extra fuel cost. A forced-draft kiln holding 5 trucks of loaded cone trays has turned out longleaf seed at moisture contents of 20 to 35 percent when all 5 truckloads have been inserted and dried simultaneously. When, however, the trucks have been moved through the same kiln progressively, removing a

truck of dry cones from the tumbler end and inserting a truck of moist ones at the cone shed end about every 2 hours, the seed has come out at about 8 to 10 percent moisture content.

Seed already extracted may be spread in shallow layers on wire-bottomed trays and dried by artificial heat in either a cone kiln or a special drier (242). Free movement of air over and among the seeds is essential. The hotter the air and the longer the exposure, the drier the seed will become, but excessive drying at any temperature may injure the seed (84). Such injury increases with temperature, with duration of temperature, and with the moisture content of seed when drying starts, and is often intensified by subsequent storage of the seed. From available data, kiln temperatures and exposures for drying longleaf seed should not exceed 115° F. and 11 hours, respectively (596). Little if any higher temperatures and longer exposures can be recommended for other southern pine seed. Even these drying schedules may cause dormancy, deterioration, or both.

In several ways direct sunlight is better than artificial heat for drying extracted seed. It reduces stied moisture content from relatively high levels to about the optimum for storage, apparently without ever reducing it too much. And although it sometimes increases seed dormancy, exposure to sunlight, in contrast to artificial heat, apparently never injures the seed. For these reasons, sunning seed in shallow layers in trays for several days is a safe and practical method for drying seed (table 10), particularly when lack of testing facilities prevents determination of moisture content. At one large nursery, seed has for many years been sunned with great success in 20-pound lots in loosely woven cotton sacks frequently

shaken up and turned over. Overnight the seed should be returned to covered metal cans or dry, closed rooms to reduce reabsorption of moisture from damp air.

The easiest and often the only feasible way to tell whether drying by artificial heat has progressed far enough or is in danger of going too far is by determining average seed moisture content and total weight at the start and then reweighing the seed during drying until it reaches a correct final weight calculated as described on p. 216.

Seed of some species endure slow drying at low temperatures better than fast drying at high temperatures (200). There is evidence that southern pine seed, especially longleaf, may belong to this class. Refrigerators in which the relative humidity is very low will greatly reduce the moisture content of southern pine seed in open-weave cloth sacks. Seed dried in this way from 13 or 15 percent moisture content to 8 to 10 percent appears to stand storage in such refrigerators better than seed placed in them after having been dried to the same level by moderate artificial heat. Where facilities are available, such refrigeration may be the best way to complete the drying of southern pine seed for storage.

In a few weeks or days, and sometimes even in a few hours, seed exposed to air of specific, constant temperature and relative humidity attains the *equilibrium moisture content* for the species and air conditions involved (86, 200, 716). That is, further exposure under the same conditions produces no further change in the moisture content of the seed.

Knowledge of the equilibrium moisture content percentages of southern pine seed at different combinations of air temperature and humidity has a direct and practical bearing upon both seed drying

TABLE 10.—*Absolute germination percentages¹ of slash pine seed stored in sealed containers after cleaning and drying by different methods*

Methods of cleaning and drying ²	Germination of—					
	Seed stored at 38° F. for—			Seed stored at room temperature for—		
	4 months	14 months	29 months	4 months	14 months	29 months
Fanning:	<i>Percent</i>	<i>Percent</i>	<i>Percent</i>	<i>Percent</i>	<i>Percent</i>	<i>Percent</i>
Sun.....	75	68	76	68	41	2
Shade.....	80	77	78	60	16	0
Flotation in water:						
Sun.....	68	80	71	66	50	15
Shade.....	83	79	65	0	0	0

¹ Number of seeds germinated divided by number of seeds with kernels. The germination period was 30 days only, without pregermination treatment to break dormancy.

² Seeds dried in the sun were exposed in a shallow layer

7½ hours per day for 3 consecutive days before final sealing in containers. Those dried in the shade were exposed in shallow layers for only 6 hours before final sealing; these seeds were dry enough externally so that dust rose from them during stirring.

and storage. Often, for example, it is the means of attaining the desired moisture content when refrigerators are used for final drying, or of maintaining the desired content when seed is stored in unsealed containers (p. 47) at any temperature. In drying seed during kiln extraction or by artificial heat after extraction, it helps to define various conditions under which the seed will dry sufficiently, including those which may result in overdrying if maintained too long.

Longleaf pine seed, like many other seeds (86, 107, 716), requires a lower relative humidity to attain certain degrees of dryness at low temperatures than it does at high temperatures (fig. 17).

Figure 17, although it is based on samples brought to equilibrium moisture content at seven different humidities at each of six temperature levels, cannot be considered a precise guide to the drying of southern pine seed because all samples were from a single lot of longleaf seed. Nevertheless, with several other samples of longleaf and slash pine seed, these curves forecast equilibrium moisture content reasonably closely (86, 178). A U. S. Forest Service cold-storage warehouse built and operated with figure 17 as a guide has kept thousands of pounds of longleaf and other southern pine seed at safe moisture contents and high viability for periods up to 4 years.

STORAGE

Sooner or later the success of practically every southern pine planting program depends upon seed which has been stored at least 1 to 3 years. The storage method used must keep a high percentage of the seed capable of vigorous germination, because low germination percentages greatly increase costs (fig. 11) (287) and much seed that germinates weakly is no better than dead seed (222, 403). Dry, cold storage²⁴ is the most effective method yet developed for southern pine seed (84, 542, 543, 730).

Even in dry, cold storage, however, the generally effective combinations of temperature and seed moisture content have failed unaccountably with some seed lots. Some storage techniques that work well with small samples fail with large lots of seed, apparently because the sheer mass of a large lot impedes drying or chilling, or prevents the dissipation of heat released during normal respiration. Certain conditions typical of most or all southern pine extractories and nurseries complicate storage. These include comparatively high air temperatures and humidities; large seed lots that require considerable time for processing and much container and storage space;

²⁴ The following references on dry, cold storage of other species give fundamental principles and practical details of the method: 71, 86, 88, 92, 107, 174, 237, 516, 604, 716, 735.

and the extreme sensitivity of longleaf seed to adverse conditions during storage.

The practical difficulties of storing southern pine seed can best be overcome if three main facts are kept in mind:

1. So long as a seed is alive, it *respires*. That is, it consumes the elaborated plant food it contains; it uses oxygen; it liberates carbon dioxide, water, and heat. The rate of respiration increases tremendously with rises in temperature and seed moisture content and with injury to the seed (365, 499). Some respiration is essential to continued life of the seed, but too much rapidly depletes the stored food on which seedling growth depends (273). Keeping respiration very little above the minimum safe level is therefore basic to successful seed storage.

2. Seed is *in storage* from the time the cone matures until pregermination treatment or sowing—not just while in containers or buildings specifically set aside for storage purposes. For example, many lots of southern pine seed properly refrigerated most of the time between extraction and use have lost significant and economically important percentages of their germinability during brief exposure to adverse conditions before refrigeration or between refrigeration and sowing.

3. Storage can succeed only when *all* influences that materially affect respiration are kept at favorable levels. Keeping just one important influence (storage temperature, for example) at optimum without controlling the rest cannot be depended upon to preserve the seed, because an injurious extreme of any other (such as seed moisture content) may then cause storage failure. The initial soundness and vitality of the seed, together with temperature and moisture content, are among the principal influences to consider (116, 174, 242, 516, 596, 694).

In the light of these three main facts, seed storage is a technique for keeping respiration at the minimum safe level, food reserves at a maximum, and embryo tissues uninjured, usually for long periods. The details of the technique may and often must be varied to fit species, available facilities, and probable duration of storage. It should be noted that any technique has a better chance of succeeding if it keeps the seed as insensitive as possible to minor or brief changes in storage environment.²⁵ For example, dry seed is unaffected by a brief period of increased temperature during the defrosting of a storage refrigerator, whereas such a change sometimes makes moist seed mold and wet seed sprout.

²⁵ This is the reverse of the object of certain pregermination treatments commonly called stratification (p. 54). This type of stratification, unlike the type used to preserve nut fruits over winter by keeping them at the high moisture content they require, should never be confused with storage (515) or be depended upon to preserve southern pine seed beyond definite, brief periods—45 days in commercial practice.

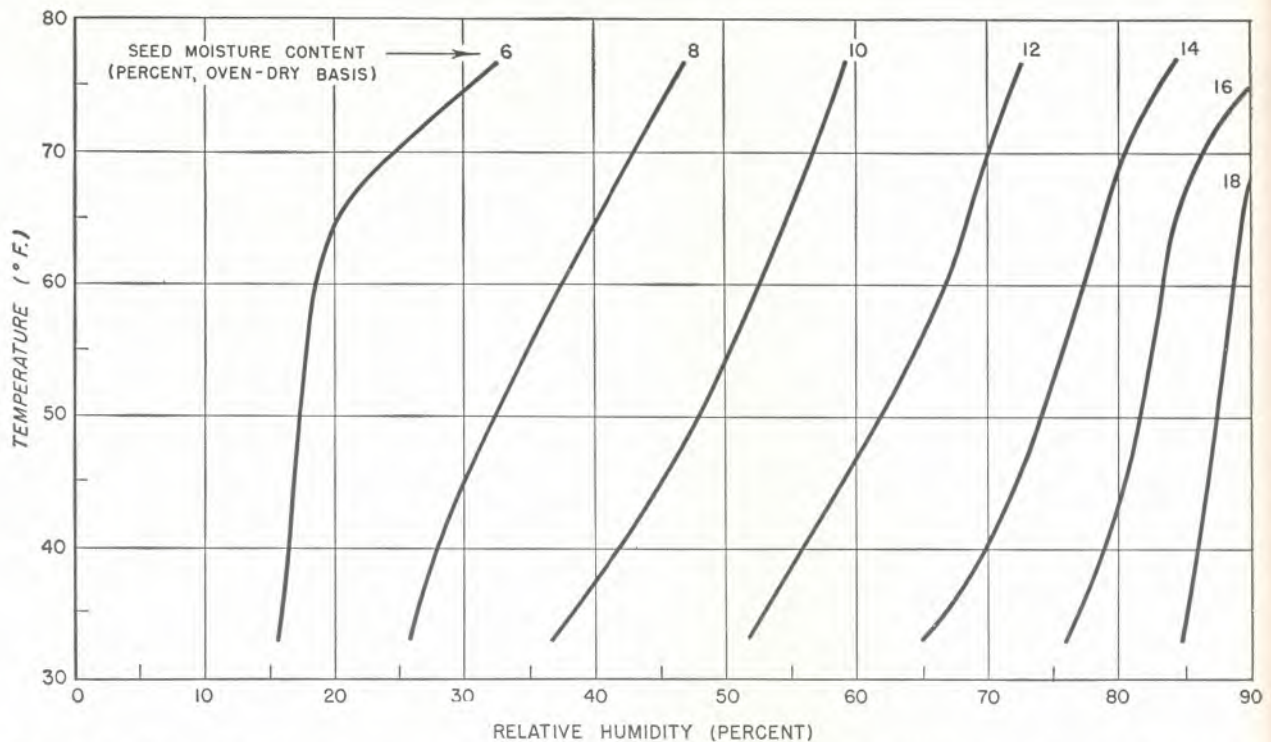

FIGURE 17.—Moisture content percentages of fresh longleaf pine seed (1938 crop, Mississippi, extracted at air temperature) in equilibrium with air at various temperatures and relative humidities. The temperature and humidity combinations needed to bring longleaf seed to moisture contents intermediate between those shown can be approximated by interpolating points between the curves.

Temperature, Moisture, and Containers

As a general rule, decreasing the storage temperature improves the keeping quality of stored seed.

In particular, temperatures above 41° F. should be avoided, because both the respiration of seeds and the deterioration of stored seeds appear to increase in rapidity with each increase in temperature above this level. Barton, for example, has shown that the germinability of longleaf seeds decreases much more rapidly at 50° than at 41° F. (86).

Temperatures between 32° and 41° F. seem about equally acceptable for storage, but even within this range the lowest temperatures probably are best.

For many years it was assumed that temperatures below 32° F. would injure the seed of the "warm climate" southern pines, but there is no evidence that this is true except where seed moisture content is very high (200). Barton found that temperatures ranging from 5° to 23° kept seed of all four principal southern pines in excellent condition for at least 6 years (84). Indeed, reanalysis of Barton's published data by statistical techniques not generally available when she began her study has shown that in many instances seed kept significantly better at these temperatures than at 41° F. This finding is of great practical importance not only because it opens the way to better

maintenance of seed viability than may be possible at 32° to 41°, but particularly because commercial cold storage facilities at approximately 5° are more generally available than those at 32° to 41°.

Within a range of several percent below a level known as the *critical moisture content percent*, the exact moisture content ordinarily has little effect on the keeping quality of uninjured seed (86). By contrast, each increase in seed moisture content above the critical moisture content percent accelerates respiration and deterioration, much as does each increase in temperature above 41° F.

The critical moisture content percent is not, however, the same for all storage conditions and all seed lots. It apparently lies at a higher level when storage temperatures are low than when they are intermediate or high; details of these relationships are presented later. It also differs greatly according to the kind of seed (86).

For longleaf pine seed stored at 32° to 41° F., the critical moisture content appears to be almost exactly 10 percent. Some evidence indicates that the critical moisture content of other southern pine seeds is the same; other findings suggest that it may be as high as 12 or 13 percent. Until higher levels are confirmed for species other than longleaf, the 10 percent level should be assumed for all southern pines.

Ordinarily, southern pine seeds should be stored approximately at or just below the critical moisture content percent (p. 51). Like other pine

seeds and fatty seeds in general, they may be dried to 6 or 5 percent without injury (200). Drying them even to 1 percent may not cause complete loss of viability (84). Even the critical moisture content percent, however, frequently induces some dormancy, and successively lower levels increase the likelihood both of severe dormancy and of permanent injury.

There is abundant evidence that *fluctuations* in seed moisture content during storage reduce viability of many kinds of seed (86, 87, 88, 116). In the light of data presented later, this seems to be true of southern pine seed.

The relative humidity inside airtight, sealed containers, or inside the storage chamber if containers are not sealed, greatly affects the success of storage (86, 87, 88, 107, 174, 178, 716) by its effect on seed moisture content, which rapidly approaches, and fairly soon stabilizes in, equilibrium with the air. Southern pine seed comes into equilibrium much as shown in figure 17.

Containers influence the keeping quality of southern pine seed largely, if not entirely, through their effect on seed moisture content. This effect depends upon whether sealing (as in glass fruit jars with rubber rings), moderately tight covering (as in slip-top tin cans), or free admission of air (as in burlap or cheesecloth sacks) maintains the initial moisture content of the seed or lets it change slowly or rapidly. There is scant evidence that refinements such as exhausting the air from sealed containers do much good; the reanalysis of Barton's data already referred to, for example, showed only slight advantages from vacuum-sealing shortleaf pine seed, and none from vacuum-sealing longleaf, slash, and loblolly seed. For these reasons, containers should be chosen primarily for their effects on seed moisture content and secondarily for low initial cost and low cost of filling and emptying (p. 51). An understanding of these facts clarifies many of the published recommendations concerning containers (71, 718).

It must be emphasized that maintaining a favorable *combination* of temperature and seed moisture content (the latter often through choosing the right container) is far more important to successful storage than is choice of temperature, initial seed moisture content, or container alone. And no combination can work well unless the seed is sound and of high vitality at the start. The following sections²⁶ on long-time and overwinter storage illustrate these facts in detail.

Storage for One or More Years

Prolonging the period of storage intensifies differences in the results obtained from different storage methods. The following studies were con-

²⁶Most of the original research reported in these, and part of that reported in several other sections on seed, was by Mary L. Nelson, formerly at the Southern Forest Experiment Station.

tinued for 5 years to show the most reliable of several different techniques for storing southern pine seed for the 1 to 3 years frequently required in practice.

Fresh longleaf pine seed from the 1937 crop, extracted at a moisture content of 18 percent and cleaned without dewinging, was stored in all possible combinations of five initial seed moisture contents, four types of containers, and two environments (commercial warehouse at 41° F., and normally heated office), a total of 40 different storage treatments (table 11). After storage for different periods, up to 5 years, samples were laboratory-tested in replicate.

Results showed that only two of the 20 air-temperature treatments kept substantial percentages of longleaf seed alive for 1 year; both involved maintenance of seed moisture content at 6 percent by sealed glass jars. No treatments kept seed alive 2 years at air temperature. At 41° F., seed kept well for 4 years and fairly well for 5 years when maintained at 6 or 9 percent moisture content. It kept well for 2 years when stored at higher initial moisture contents in containers that permitted drying in storage. Maintained high moisture contents consistently reduced the duration of successful storage; longleaf seed maintained at 18 percent moisture content by sealed jars deteriorated considerably within 1 year and was dead at the end of 2 years, despite refrigeration. Sealed containers, which kept the seed dry, were superior to unsealed when seed was stored at initial moisture contents of 6 and 9 percent. Unsealed containers, because they enabled the seed to dry out, were superior to sealed when initial moisture contents were 15 or 18 percent.

A similar test using only two types of containers was made on slash pine seed of the 1939 crop, freshly extracted, dewinged, and cleaned, and with an original seed moisture content of 18 percent (table 12). As with longleaf pine seed (table 11) and with the slash pine seed earlier reported (table 10), cold storage proved far superior to storage at office air temperature. At air temperature, the slash seed placed in storage at 6 to 15 percent moisture content held up fairly well for 1 year in either sealed glass jars or slip-top tin cans. So did seed initially at 18 percent when stored in slip-top cans, presumably because the cans permitted some drying. In sealed jars, seed at 18 percent moisture content died within the first year. At air temperature, only the seed maintained at 6 percent moisture content by sealed jars remained usefully viable for 2 years, and no combination kept seeds alive beyond the third year. By contrast, all lots of slash seed stored at 41° F. remained usefully viable for 5 years.

Two distinct patterns of deterioration were observed, however, among slash pine samples stored at 41° F. (table 12). First, the seed maintained at 18 percent moisture content by sealed glass jars deteriorated badly during the fourth and fifth

TABLE 11.—Germination percent at 32 to 38 days of longleaf pine seed with varying seed moisture contents stored from 1 to 5 years at two temperature levels

Approximate initial moisture content of seed and storage container ²	Germination—						
	Before storage	After air-temperature storage for—		After storage at 41° F. for—			
		1 year	2-5 years	1 year	2 years	4 years	5 years
6 percent:	<i>Percent</i>	<i>Percent</i>	<i>Percent</i>	<i>Percent</i>	<i>Percent</i>	<i>Percent</i>	<i>Percent</i>
Sealed glass jar.....	77	62	0	88	82	71	47
Sealed glass jar with charcoal.....	77	36	0	89	88	61	55
Slip-top tin can.....	77	1	0	84	86	52	32
Cheesecloth sack.....	77	0	0	85	92	60	21
9 percent:							
Sealed glass jar.....	76	1	0	89	92	78	40
Sealed glass jar with charcoal.....	76	2	0	89	87	75	43
Slip-top tin can.....	76	1	0	88	83	58	14
Cheesecloth sack.....	76	0	0	82	84	48	28
12 percent:							
Sealed glass jar.....	83	0	0	85	87	32	18
Sealed glass jar with charcoal.....	83	0	0	90	75	48	17
Slip-top tin can.....	83	1	0	96	84	41	16
Cheesecloth sack.....	83	1	0	82	76	30	15
15 percent:							
Sealed glass jar.....	83	0	0	69	78	14	13
Sealed glass jar with charcoal.....	83	0	0	69	71	37	1
Slip-top tin can.....	83	1	0	87	73	41	19
Cheesecloth sack.....	83	0	0	82	76	42	16
18 percent:							
Sealed glass jar.....	87	0	0	50	0	0	0
Sealed glass jar with charcoal.....	87	0	0	70	1	0	3
Slip-top tin can.....	87	0	0	86	79	30	5
Cheesecloth sack.....	87	1	0	77	76	46	21

¹ Germination percentages were transformed to arc sin $\sqrt{\text{percentage}}$ values for analysis of variance. All averaging was performed on transformed values, and the averages were then converted back to the percentages given. This transformation and the reasons for it are discussed by Bartlett and Snedecor (81; 676, pp. 445-450).

² Sealed glass jars maintained initial moisture contents essentially unchanged throughout storage; slip-top tin cans permitted gradual increases of low moisture contents and decreases of high ones; cheesecloth sacks permitted similar but more rapid changes.

years as compared to all other lots stored in glass at 41°. Second, the lots originally at 6 and 9 percent moisture content, and stored in cans at 41°, deteriorated distinctly more by the end of the fifth year than did the moister lots in cans. This deterioration of seed dried below the level of moisture equilibrium with the air of the storage chamber and allowed to increase in moisture content during storage has been observed in other studies and in commercial storage of southern pine seed. It seems to be an instance of the unfavorable effect, previously mentioned, of fluctuating moisture content during storage.

The results of several other longleaf and slash pine storage studies confirm and extend the results just described. A 2-year study of 1936 longleaf seed, for example, showed that at 38° F., seed at 18 and 22 percent moisture content deteriorated seriously within 1 year and died within 2 years, whereas seed at 6 to 13 percent moisture content kept reasonably well for 2 years at this temperature. At office air temperature in the same

study, seed maintained 1 and 2 years at 6 percent moisture content germinated 49 and 20 percent, respectively, whereas seed maintained at 10 to 22 percent moisture content failed to keep even 1 year. In another study, longleaf seed germinated 61 percent and slash seed germinated 91 percent after 10 and 17 years respectively at 35° to 38° and approximately 10 percent seed moisture content.

These studies show that slash pine seed is less exacting than longleaf in its requirements for long storage, but suggest strongly that it should be refrigerated at a moisture content no higher than 12 percent, and no lower than 9 percent unless sealed containers are used. Less is known about the combined effects of storage temperature and seed moisture content upon the keeping qualities of loblolly and shortleaf pine seed. From earlier studies (84, 542, 543), and results in commercial practice, however, it is clear that storage requirements for loblolly and shortleaf seed resemble those for slash seed more closely than those for

TABLE 12.—Germination percent¹ at 31 to 35 days of slash pine seed with varying seed moisture contents stored from 1 to 5 years at two temperature levels

Initial moisture content and container ²	Germination—								
	Before storage	After air-temperature storage for—			After storage at 41° F. for—				
		1 year	2 years	3 years ³	1 year	2 years	3 years	4 years	5 years
6 percent:	<i>Percent</i>	<i>Percent</i>	<i>Percent</i>	<i>Percent</i>	<i>Percent</i>	<i>Percent</i>	<i>Percent</i>	<i>Percent</i>	<i>Percent</i>
Sealed glass jar	57	62	50	1	76	71	75	72	74
Slip-top tin can	57	58	7	0	77	74	81	79	52
9 percent:									
Sealed glass jar	65	65	1	1	76	84	74	75	65
Slip-top tin can	65	61	2	0	77	80	86	77	59
12 percent:									
Sealed glass jar	63	41	1	0	77	86	65	64	74
Slip-top tin can	63	53	4	1	76	75	75	75	71
15 percent:									
Sealed glass jar	63	56	6	0	73	87	67	70	60
Slip-top tin can	63	64	3	0	76	86	77	71	66
18 percent:									
Sealed glass jar	62	0	0	0	71	84	72	57	45
Slip-top tin can	62	57	7	0	71	80	87	69	64

¹ See footnote 1, table 11.

² Sealed glass jars were intended to maintain initial moisture contents throughout storage, but moisture-content determinations at the time of some tests showed that moisture contents of a few samples had changed appreciably. The slip-top tin cans permitted the moisture

contents to change much more freely; in general, the high ones decreased and the low ones increased by several percent.

³ No samples stored at air temperature were viable after the third year.

longleaf. Shortleaf seed, like slash, has been stored successfully for 17 years at 35° to 38° F. and approximately 10 percent seed moisture content, whereas longleaf has not been stored successfully under these conditions for more than 10 years.

Overwinter Storage

The need for special storage treatments to preserve southern pine seed from collection in the fall until sowing the following spring became painfully evident in 1935 and 1936. In those years thousands of pounds of longleaf seed in unheated buildings deteriorated badly or spoiled completely within 2 months after extraction. Simultaneously, it was discovered that less readily discernible deterioration of seed overwinter was a principal cause of low nursery tree percent (345). The following studies were undertaken to learn what weaknesses in current practices were causing losses of seed and whether techniques less exacting than those required for several years' storage could be depended upon to keep seed over winter.

Longleaf pine seed extracted in November 1936 at a moisture content slightly in excess of 22 percent was prepared for storage in December in all eight possible combinations of two moisture contents, seed wings on and off, and two types of container (table 13). Laboratory germination percentages of the seed when placed in containers

were: Dry, wings on, 69 percent; dry, wings off, 66 percent; wet, wings on, 78 percent; and wet, wings off, 76 percent.

Seed in each of the eight combinations was stored in each of four contrasting environments (table 13), making 32 different storage treatments in all. The 2-bushel bags and the 30-gallon cans were in a large, unheated nursery storeroom containing several tons of fresh longleaf seed in burlap bags; the shelf was near the ceiling of the same room. The refrigerator and open shelf duplicated environments used in earlier laboratory studies of seed storage. The bags and cans duplicated environments common in large-scale storage. The previous year there had been wholesale spoilage of longleaf seed stored at about 20 percent moisture content in 30-gallon ash cans.

In the refrigerator and on the shelf, the containers were spaced to allow free air circulation around each cheesecloth sack and glass jar. In the 2-bushel bags, each sack or jar was completely surrounded by moist seed with the wings on; in the ash cans, by moist dewinged seed. In the refrigerator, the wet seed in cheesecloth sacks dried considerably through condensation of moisture on the cooling unit. In the burlap bags, on the shelf, and in the ash cans, most of the wet seed in cheesecloth sacks dried considerably, and the dry seed in cheesecloth sacks in the ash cans became more moist; the direction and extent of these changes depended on the moisture equilibrium which de-

TABLE 13.—Average germination percent in laboratory and two nurseries of longleaf pine seed stored 2 1/2 months by different methods

Environment and container	Seed moisture content		Average germination of—					
	Initial	Apparent during storage ²	Seed with wings on			Seed with wings off		
			Laboratory	Stuart Nursery	Ashe Nursery	Laboratory	Stuart Nursery	Ashe Nursery
Refrigerator, ³ 38° F.:	<i>Percent</i>		<i>Percent</i>	<i>Percent</i>	<i>Percent</i>	<i>Percent</i>	<i>Percent</i>	<i>Percent</i>
Glass.....	9	Constant (low).....	71	70	66	60	70	60
Cloth.....	22	Greatly reduced.....	73	73	72	72	61	64
Do.....	9	Slightly reduced.....	70	65	76	65	56	61
Glass.....	22	Constant (high).....	80	80	79	73	55	41
Average.....			74	72	73	67	61	57
2-bushel burlap bags: ⁴								
Glass.....	9	Constant (low).....	67	68	65	64	59	57
Cloth.....	22	Greatly reduced.....	50	53	59	38	38	42
Do.....	9	Fluctuating, but low.....	43	59	50	40	44	36
Glass.....	22	Constant (high).....	57	0	5	0	0	2
Average.....			54	38	42	29	29	30
Storehouse shelf:								
Glass.....	9	Constant (low).....	62	67	69	54	67	52
Cloth.....	22	Greatly reduced.....	54	63	56	51	48	39
Do.....	9	Fluctuating, but low.....	53	60	61	36	38	37
Glass.....	22	Constant (high).....	1	1	1	0	0	1
Average.....			36	41	40	29	31	28
30-Gallon galvanized iron cans: ⁵								
Glass.....	9	Constant (low).....	68	73	70	68	61	60
Cloth.....	22	Considerably reduced.....	16	43	30	1	25	24
Do.....	9	Somewhat increased.....	29	28	22	6	5	11
Glass.....	22	Constant (high).....	41	0	1	21	0	3
Average.....			38	30	26	18	16	21
Grand average.....			51	45	45	35	34	33

¹ See footnote 1, table 11. Major failures of laboratory germination to predict nursery germination are indicated by bold-faced type.

² Judged from determinations of moisture content of surplus seed from samples tested in laboratory, and from general observations of environments.

³ Air inside very dry, because of condensation of moisture on cooling unit.

⁴ Filled with seed at about 20 percent moisture content and with wings on. Seed better aerated than that in galvanized iron can; temperature probably lower and certainly more uniform than that on storehouse shelf.

⁵ Filled with seed at about 20 percent moisture content and with wings reduced to stubs. Aeration poor; temperature, because of respiration of seed, probably higher than in any other environment.

veloped between the samples and the surrounding air, or air and moist seed. In all four environments, the sealed glass jars kept the stored samples essentially at their initial moisture contents of 9 or 22 percent.

Each of the 32 different treatments was applied to 3 samples. In March 1937, at the height of the sowing season and after only 2 1/2 months' storage, the samples were used for simultaneous, comparable germination tests in the laboratory and in the seed beds of two U. S. Forest Service nurseries. Germination in the laboratory and in each nursery ranged from about 80 percent down to zero, depending upon storage treatment (table 13). One-fourth of the 32 different treatments resulted in

laboratory or nursery germination, or both, of less than 10 percent—a striking illustration of the importance of correct overwinter storage.

Almost without exception, the seed with wings on germinated better, and in many instances conspicuously better, than similarly stored and tested seed with wings reduced to stubs (table 13). The refrigerator was by far the most favorable environment and the galvanized iron can full of moist dewinged seed was distinctly the least favorable. Within environments, keeping quality varied greatly with container and initial seed moisture content. Germination of seed stored in the refrigerator ranged downward from 80 to 41 percent; that in each of the other 3 environments

ranged downward from about 60 or 70 percent to zero.

The average germination percentages of the samples stored in cheesecloth containers were generally somewhat higher than those of the corresponding samples stored in sealed jars (table 14). The averages for all samples dried to 9 percent moisture content consistently excelled those placed in storage at 22 percent moisture content. The greatest differences (table 14), however, appear among the average germination percentages of seed kept at constant low, fluctuating intermediate, and constant high moisture contents throughout the 2½ months of storage. These results show that containers were relatively unimportant by themselves but extremely important in connection with initial seed moisture content. Where containers kept dry seed dry or allowed moist seed to dry, results were excellent or good, but where they allowed dry seed to become moist again, and especially where they kept moist seed moist (except at 38° F.), they injured or ruined the seed (table 13).

In neither nursery did the average germination for all treatments differ significantly from the laboratory average—an important point in connection with seed testing and nursery sowing rates (pp. 64 and 74). In 6 of the 32 individual treatments, however, there were serious discrepancies in germination between laboratory and nursery, or between the two nurseries (bold-face figures, table 13). The concentration of these discrepancies among samples of seed at high moisture content, or dewinged, or both, and especially in the galvanized iron cans, shows that, in addition to wasting seed and increasing costs, incorrect overwinter storage may decrease the reliability of germination tests as guides to sowing rates.

Longleaf pine seed of the 1937 crop, freshly extracted at a moisture content of 18 percent and cleaned without dewinging, was stored for 1 and for 3½ months at each of 60 possible combinations of 5 seed moisture contents, 4 containers, and 3 environments (electric refrigerator at 38° F., unheated shed, and normally heated office) (fig. 18). Laboratory germination tests, in replicate, confirmed and extended the results of the 1936 overwinter storage test.

At the end of 1 month, very significant differences in germination appeared among the averages for the three environments—refrigerator 80 percent, unheated shed 76 percent, and heated office 71 percent.

At the end of 3½ months, not only temperatures, but also seed moisture contents and containers, both alone and in combination, had very significantly affected the germinability of the stored seed. Average germination percents for refrigerator, unheated shed, and heated office were 63, 35, and 29 percent, respectively. For seed with initial moisture contents of 6, 9, 12, 15, and 18, average germination percents were 53, 50, 46, 37, and 24 percent, respectively. For slip-top tin can, cheesecloth sack, sealed glass jar with charcoal, and sealed glass jar without charcoal, they were 47, 46, 39, and 36 percent, respectively; here the can and cloth did not differ significantly, nor did the two jars, but all other differences among containers were significant.

The interactions between initial moisture content and container—that is, the *differential responses* of seed at various moisture contents to various containers—were very significant and of great practical interest (fig. 18). When longleaf seed entered storage at 6 or 9 percent moisture content, sealed containers, which kept it dry, were

TABLE 14.—Average laboratory and nursery germination of longleaf pine seed stored 2 1/2 months, for various storage conditions

Storage condition	Average germination ¹ of—					
	Seed with wings on			Seed with wings off		
	Laboratory	Stuart Nursery	Ashe Nursery	Laboratory	Stuart Nursery	Ashe Nursery
	Percent	Percent	Percent	Percent	Percent	Percent
Container:						
Cloth.....	48	56	52	35	38	38
Glass.....	53	35	39	35	29	29
Initial moisture content:						
9 percent.....	58	61	59	48	49	46
22 percent.....	43	30	32	23	20	22
Moisture content during storage:						
Constant, 9 percent (in glass).....	67	70	68	62	64	58
Fluctuating intermediate (all seed in cheesecloth).....	48	56	52	35	38	38
Constant, 22 percent (in glass).....	39	8	13	13	4	7

¹ See footnote 1, table 11, p. 48.

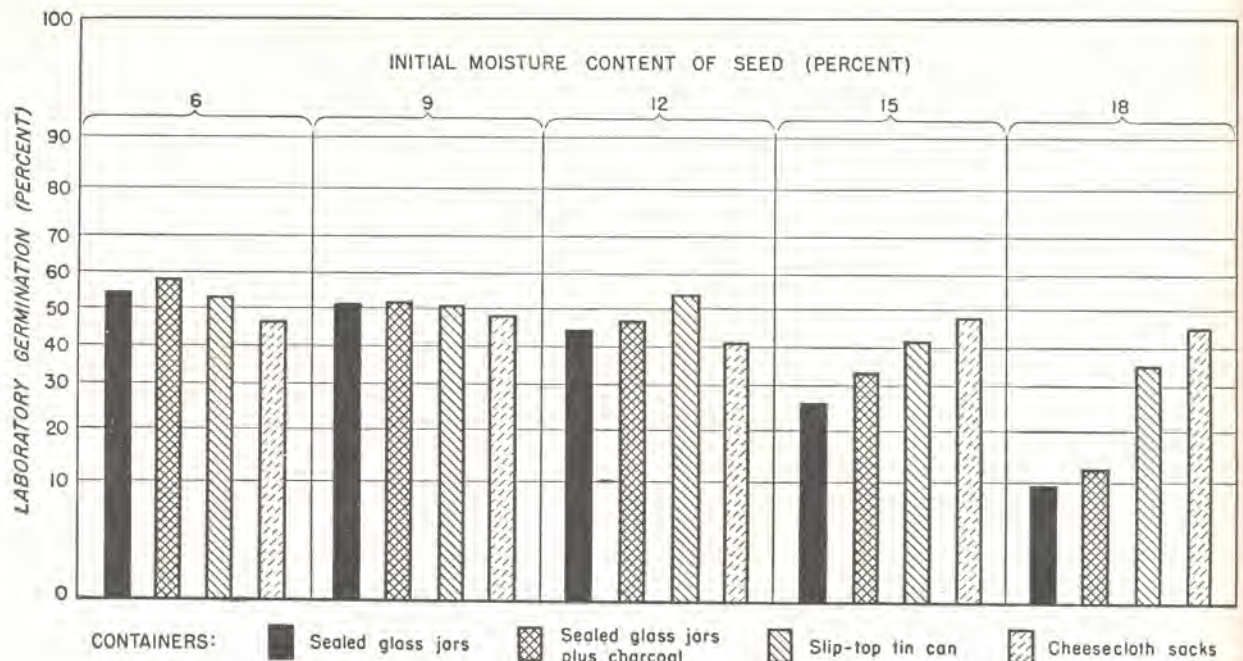

FIGURE 18.—Varying effects of containers upon 1937 longleaf seed stored 3½ months, depending upon initial moisture content of seed. (Averages of samples stored at 38° F., in unheated shed, and in heated office. The specially graduated percentage scale is necessary when averages are derived from arc sin $\sqrt{\text{percentage values}}$ (87; 676, pp. 445-450).)

slightly better than unsealed. When seed went into storage at 15 or 18 percent, sealed containers, because they kept it wet, were far poorer than unsealed, even for so brief a storage period as 3½ months.

When the three-way interactions of temperature, initial moisture content, and container were analyzed at the end of 3½ months' storage, the results very strongly confirmed the findings of the 1936 study in favor of dry cold storage, with drying during cold storage as second choice, and dry storage at intermediate temperatures as third choice, even for the short period between extraction and spring sowing.

In a study of slash pine seed from the 1939 crop, closely paralleling the 1937 longleaf overwinter storage study, seed stored at an initial moisture content of 18 percent had a significantly lower laboratory germination percent after 3½ months than did seed going into storage at 6, 9, 12, or 15 percent moisture content. No other significant differences in germination developed in the 3½ months of storage, but the pattern of differences was consistent with that in the longleaf overwinter studies; the slash seed, for example, kept best at 38° F., next best in the unheated shed, and least well in the heated office. These results show that slash seed is less exacting than longleaf seed in its requirements for overwinter storage, but that it should not be held at a moisture content above 15 percent, and should probably be kept considerably drier than 15 percent, and in unheated buildings if refrigerators are unavailable.

Cold Storage Time Schedules

The exact times at which southern pine seed is both placed in and removed from cold storage may be more important than the precise levels of temperature and seed moisture content during storage.

There should be minimum possible delay in placing seed in cold storage. The germinability of extracted seed held at air temperature in unheated buildings, and in moisture equilibrium with the air, may decrease seriously within 4 to 8 weeks. When extraction is delayed too long, germinability may decrease while the seed is still in the cones (p. 36). Even if immediate germinability is not affected, rapid respiration before cold storage depletes the food reserves within the seed. Refrigeration applied later cannot restore the loss, and is therefore less effective than if it had been applied promptly. For these reasons the common practice of holding seed at air temperature until part of it has been sown the spring after extraction, and then refrigerating the rest for use in later years, should be avoided. It is much better to place all the seed in cold storage currently as it is extracted and to withdraw it as needed immediately before sowing. A possible alternative, if refrigerator space is at a premium, is to refrigerate immediately all seed to be held for a year or more and to keep overwinter at air temperature only the minimum estimated amount likely to be sown the spring after extraction.

Removing seed from cold storage and holding it at natural air temperatures or in heated rooms be-

fore sowing or testing may be even more harmful than holding it at such temperatures before it has been sensitized (499) by refrigeration. This has been shown most clearly with longleaf pine, which deteriorates significantly within 2 to 4 weeks, especially if at high moisture content, but results with commercial lots of other species indicate that no southern pine seed should be removed from cold storage more than a week before sowing or testing.

Deferring removal in this way ordinarily is simple when seed is stored near the point of use. It may be impossible, however, in shipping seed abroad, especially to the Southern Hemisphere, where the sowing season differs by 6 months from that in the United States. Rather than expose refrigerated seed to possible high temperatures in transit, it is preferable to arrange export well in advance, ship seed immediately after extraction and cleaning, and keep it in cold storage at its destination from receipt until sowing time.

Miscellaneous Details of Storage Technique

Fungi or bacteria do not seem to affect stored southern pine seed adversely unless other deterioration is already far advanced. Deterioration, as in cotton seed (44), seems to arise mostly from the vital processes of the seed itself. Treating seed with formaldehyde before storage has shown no beneficial fungicidal action. Dusting longleaf seed with a standard organic-mercury fungicide before storage maintained viability no better than in the untreated check and caused abnormal germination like that reported with several other kinds of seed treated with mercury compounds (116, 412).

Storing seed in sealed containers with suitable amounts of a desiccant such as quicklime (CaO) has kept small samples of southern pine and other seeds at constant, low moisture content percent (84, 88), but has not been developed in commercial practice with southern pine seed.

For sealed storage of commercial lots, gasketed grease drums and glass carboys have proved most satisfactory, except that longleaf seed will not pour freely through the narrow necks of the carboys. Burlap or cotton bags are most satisfactory when quick moisture equilibrium with the air in the storage chamber is permissible or desired. Covered ash cans, garbage cans, and shortening cans, although they do not prevent changes of moisture content of the seed inside, delay such changes, particularly if the covers are fastened with wax or tape. Some cans, however, may be sealed, as for overseas shipment, with caulking compound or by soldering.

Samples sent to a seed laboratory for moisture content determination should be placed in screw-topped glass fruit jars, with the covers very firmly screwed down on fresh rubber rings. Samples drawn from cold storage for either moisture content determinations or germination tests, and

especially drawn from stratified lots for germination tests, should be sent to the laboratory in tightly corked thermos bottles. Preferably, all such samples should fill the jars or thermos bottles completely.

Sealing charcoal in with seed to absorb moisture and gases has been recommended, especially for overseas shipment. Proper quantities of dry, "activated" charcoal might have this effect and benefit the seed. The available commercial charcoal (such as is fed to chickens) that was used in sealed glass jars in the 1937 longleaf storage study did not significantly increase average survival. In both long storage (table 11) and overwinter storage (fig. 18), the treatment gave less uniform results than sealing the seed in jars without charcoal.

Postponing dewinging until after storage has long been recognized as a means of improving keeping quality (71). Eliason and Heit (242) emphasize the possible adverse effects of dewinger damage as well as of kiln injuries on stored red pine seed. In the overwinter storage study of longleaf pine seed of the 1936 crop (table 13), the seed with wings attached withstood storage very significantly better than dewinged seed. The U. S. Forest Service regularly stores longleaf pine seed with the wings on, though it usually dewings slash, loblolly, and shortleaf seed before storage.

Recommendations

For storage beyond the first spring following extraction.—Provided seed moisture content can be kept constant after preparation for storage, the seed should :

a. Be extracted, dewinged (longleaf pine seed should be left with wings attached), and cleaned with minimum injury ;

b. Be dried to 6 to 9 percent moisture content for longleaf, or 9 to 12 percent moisture content for slash, loblolly, and shortleaf (but see p. 44 for completion of drying in refrigerator) ;

c. Be placed in cold storage within a week or two after extraction, cleaning, and drying;

(1. Be stored at a temperature not higher than 41° F., preferably at 5° to 32°; and

e. Be removed from cold storage not more than a week before testing or sowing, or before pre-germination treatment if such treatment is necessary.

The seed can be maintained at constant low moisture content either by sealing the containers, or by storing it in air-permeable containers in a refrigerator having a constant low relative humidity (fig. 17).

If sealed containers cannot be used and the seed must be stored in a refrigerator too humid to maintain the moisture content at the most favorable level, the seed should be placed in storage at or slightly above the moisture content at which it will come into equilibrium with the air in the re-

frigerator. Reducing the seed moisture content below this level and letting it rise in storage should be avoided, as should repeated changes in moisture content during storage.

If storage at 41° F. or below is impossible, seed of all species should be kept at 6 percent moisture content in sealed containers at the lowest temperature available. (See tables 10, 11, and 12.)

For overwinter storage only.—*Preferably*, seed should be stored overwinter precisely as for longer periods; that is, refrigerated at 41° F. or below, at constant moisture content of 6 to 9 percent for longleaf pine, or 9 to 12 percent for slash, loblolly, and shortleaf pine, and otherwise as described for long storage.

Second choice, refrigeration at or below 41° F., at constant moisture content not above 15 percent (any species).

Third choice, storage at temperatures as little as possible above 41° F., and at constant moisture content of 6 to 9 percent for longleaf pine, or 9 to 12 percent for slash, loblolly, and shortleaf.

For shipment abroad, especially to the Southern Hemisphere.—*Preferably*, ship immediately after extraction and cleaning, in sealed containers, at moisture content of 6 to 9 percent for longleaf pine, or 9 to 12 percent for slash, loblolly, and shortleaf pine. Receiver should refrigerate seed at 41° F. or lower (p. 46), at the same or lower moisture content (the latter will necessitate unsealing the containers) from receipt until use.

Second choice (especially applicable to seed already refrigerated before shipment), ship at moisture content similar to the above, either in refrigerated holds or by air express with instructions to keep as cool as possible. Refrigerate from receipt until use.

PREGERMINATION TREATMENTS

Although southern pine seed is inherently capable of prompt and complete germination immediately after maturity, some lots later become more or less *dormant*, that is, incapable of responding well to even ideal testing or seedbed conditions. Because of this, some seed will not germinate with maximum possible speed or completeness unless it is given special treatment before testing or sowing.

Pregeneration treatments may be applied to improve either speed or completeness, or both. In testing, their main purpose is to assure completeness. In the nursery, a treatment that speeds germination may often be justified (p. 76) even if it somewhat reduces completeness. Treatments almost invariably are limited to a few weeks, days, or hours, and must not be extended over long, indefinite periods. They are supplements to storage; attempts to substitute them for correct storage treatments may ruin the seed.

Dormancy

The dormancy of southern pine seeds is simpler than that of some other seeds. Dormant pine seeds have nondormant embryos and permeable seed coats, and characteristically break dormancy in response to a single chilling while at high moisture content, apparently through improved movement of nutrients and accessory foods from the endosperm into the embryo (200, 715).

Seed dormancy seems commonest and most severe in loblolly and shortleaf pine, less so in slash, and usually negligible in longleaf. It may occur in the most highly viable seed (82, 84, 543) as well as in seed of reduced viability. Apparently it may result from too long drawn out extraction at air temperature, or from extraction in too hot a kiln. As with vegetable seed (716), it may result either from adverse storage conditions, or from otherwise beneficial drying in storage. Tables 10, 11, and 12 and the text accompanying table 13 give examples of partial dormancy from drying before storage.

Decision as to whether to treat any particular lot of seed for dormancy can best be made after the seed has been received and tested (p. 56). Varying degrees of dormancy are, however, common enough among seed lots in general to require facilities for treatment at all laboratories and most nurseries in which southern pine seed is tested or sown. Methods must therefore be selected and equipment obtained before operations start.

Stratification ²⁷

Although by no means infallible, stratification has worked better and has been more widely used with southern pine seed than has any other pregermination treatment. It was first applied to southern pine seed by Barton of Boyce Thompson Institute, in 1927 (82). Applied to seed lots handled by methods then in current use, Barton's techniques doubled the germination of most southern pine seed and reduced the period required for germination by approximately three-fourths. In both seed testing and nursery sowing, and to some extent in direct seeding, the treatment rapidly came into common use with many American conifers (11, 65, 66, 67, 68, 83, 84, 92, 398, 461, 465, 470, 485, 515, 596, 642, 711, 712, 736, 750).

The treatment depends for its success on keeping seed moist but aerated, at a temperature high

²⁷The term *stratification* was originally applied to outdoor storage of layers of hardwood seed between layers of moist sand in pits in the ground (718). Its application to the pregermination treatment described here, in which the seed may be mixed uniformly with the moist medium instead of being kept in strata, is inexact (680), but is convenient and generally understood. Throughout this publication, *stratification* is used in the sense of pregermination treatment. Such stratification should never be mistaken for storage (461, 515).

enough to avoid injury but too low to permit germination, for a period appropriate to the state of dormancy of the particular seed lot.

Temperature.—Despite some conflicting reports (82, 4B1), temperatures between 38° and 41° F. are recommended for stratifying loblolly, slash, and shortleaf pine seed. A temperature of 35° probably is acceptable for these species, and is recommended for longleaf pine seed if it needs treatment; at 41°, longleaf seed sometimes germinates in the refrigerator within a month. The temperature among the seed and intermingled moist medium should never drop below 32°, lest the seed be injured (71). If the relative humidity in the refrigerator is low, rapid evaporation may reduce the temperature of seed and moist medium below that of the air, and cause formation of ice crystals among, or freezing of, the medium and seed. Use of fairly tight (but not sealed) containers, and of refrigerator temperatures of at least 37°, seem sensible precautions.

Duration.—Several workers (82, 84, 461), from results with laboratory samples, have advised 2 and 3 months stratification for all southern pine except longleaf. It seems probable that the samples used by these investigators had become highly dormant from storage in heated buildings. Two- and three-month periods seem most effective with such stubbornly dormant seed lots.

Two- and three-month treatments, however, have been found unnecessary, time-consuming, and inconvenient for most germination test samples, and injurious to some. Practical nurserymen have found these periods unsatisfactory for nursery sowing lots. With such lots, prolonged stratification complicates refrigeration and sowing schedules and increases refrigeration and labor costs. Furthermore, despite the low temperature inside the refrigerator, large masses of seed, unlike laboratory samples, sometimes heat after 2 months or more at high moisture content. Several expensive and irreplaceable lots of southern pine seed have been ruined by such heating. By contrast, some nurserymen have satisfactorily stimulated the germination, especially of longleaf and slash pine seed, with 20- and even 15-day treatments. In one instance, 3- and 8-day treatments have effectively broken dormancy of slash and loblolly pine seed, respectively.

From the available evidence, 30-day stratification is recommended for both germination tests and nursery sowing. Shorter periods may be used where local experience has demonstrated their effectiveness. Because of the danger of heating after longer treatment, stratification of seed lots larger than 5 pounds (dry weight) should be limited to a maximum of 45 days.

Moist media.—Granulated acid moss peat is recommended. Fine quartz sand or sawdust is satisfactory, shredded sphagnum moss somewhat less so. The main requisites are that the medium

absorb and hold water well, and not cake, heat, ferment, or decay during treatment. Ease of separation from seed at the end of treatment is an advantage. So is low initial cost, as the material should not be used a second time.

A volume of peat moss, sand, or sawdust at least equal to that of the seed is necessary and two or three times as much probably is best.

Degree of moistness.—Any moisture content above 25 percent of the moisture-holding capacity (not the weight) of the medium is satisfactory (461), provided only that the seeds are not actually submerged in water.

Containers.—If they maintain the moist medium between 25 and 100 percent saturation, nearly any covered containers will do. They should not admit air very freely, lest the medium and seed dry unevenly or too much, but, regardless of size, they should not be sealed. With lots of seed weighing more than 1 or 2 pounds, the containers must be drained. Thirty-gallon ash cans have worked well when equipped with slightly elevated false bottoms of reinforced screen wire or perforated wood. So have wooden sugar barrels with a few small holes in the bottoms.

The larger the seed lots being treated, the more likely they are to dry unevenly, become waterlogged at the bottom, or heat. Large lots should therefore be inspected, remoistened, drained, repacked, or stirred regularly at least once a week.

Mixing and separating seed and medium.—The seed can be kept separate throughout stratification by filling the container with alternate layers of seed and medium, separated by screen wire or thin, coarse cloth. This works satisfactorily if: (1) The layers of seed are never more than 2½ to 3 inches (preferably only ½ to 1 inch) thick; (2) the alternate layers of moist medium are at least as thick as the layers of seed; and (3) the seed, medium, and separators are so arranged that the seed may be inspected, aerated, and if need be stirred and repacked, without difficulty. The most popular method of meeting these conditions, particularly the last, is to place 10- or 20-pound lots of dry seed in cotton cloth sacks large enough to hold double the amounts, immerse them in water to wet the seed, flatten them into disks not more than 2½ to 3 inches thick, and alternate them with layers of moist medium in a drained barrel or can. Putting the same dry weight of seed in each sack permits easy allocation of seed to seedbeds despite gains in weight during stratification.

Mixing the seed uniformly with the moist medium is sometimes more effective than alternating layers of seed and medium. In preparing the seed for treatment, mixing cracked ice with slightly moistened medium and seed chills the entire mass quickly and uniformly, and reduces caking and packing. Such icing has given excellent results, especially with longleaf seed.

frigerator. Reducing the seed moisture content below this level and letting it rise in storage should be avoided, as should repeated changes in moisture content during storage.

If storage at 41° F. or below is impossible, seed of all species should be kept at 6 percent moisture content in sealed containers at the lowest temperature available. (See tables 10, 11, and 12.)

For overwinter storage only.—Preferably, seed should be stored overwinter precisely as for longer periods; that is, refrigerated at 41° F. or below, at constant moisture content of 6 to 9 percent for longleaf pine, or 9 to 12 percent for slash, loblolly, and shortleaf pine, and otherwise as described for long storage.

Second choice, refrigeration at or below 41° F., at constant moisture content not above 15 percent (any species).

Third choice, storage at temperatures as little as possible above 41° F., and at constant moisture content of 6 to 9 percent for longleaf pine, or 9 to 12 percent for slash, loblolly, and shortleaf.

For shipment abroad, especially to the Southern Hemisphere.—Preferably, ship immediately after extraction and cleaning, in sealed containers, at moisture content of 6 to 9 percent for longleaf pine, or 9 to 12 percent for slash, loblolly, and shortleaf pine. Receiver should refrigerate seed at 41° F. or lower (p. 46), at the same or lower moisture content (the latter will necessitate unsealing the containers) from receipt until use.

Second choice (especially applicable to seed already refrigerated before shipment), ship at moisture content similar to the above, either in refrigerated holds or by air express with instructions to keep as cool as possible. Refrigerate from receipt until use.

PREGERMINATION TREATMENTS

Although southern pine seed is inherently capable of prompt and complete germination immediately after maturity, some lots later become more or less *dormant*, that is, incapable of responding well to even ideal testing or seedbed conditions. Because of this, some seed will not germinate with maximum possible speed or completeness unless it is given special treatment before testing or sowing.

Pregermination treatments may be applied to improve either speed or completeness, or both. In testing, their main purpose is to assure completeness. In the nursery, a treatment that speeds germination may often be justified (p. 76) even if it somewhat reduces completeness. Treatments almost invariably are limited to a few weeks, days, or hours, and must not be extended over long, indefinite periods. They are supplements to storage; attempts to substitute them for correct storage treatments may ruin the seed.

Dormancy

The dormancy of southern pine seeds is simpler than that of some other seeds. Dormant pine seeds have nondormant embryos and permeable seed coats, and characteristically break dormancy in response to a single chilling while at high moisture content, apparently through improved movement of nutrients and accessory foods from the endosperm into the embryo (200, 715).

Seed dormancy seems commonest and most severe in loblolly and shortleaf pine, less so in slash, and usually negligible in longleaf. It may occur in the most highly viable seed (82, 84, 543) as well as in seed of reduced viability. Apparently it may result from too long drawn out extraction at air temperature, or from extraction in too hot a kiln. As with vegetable seed (716), it may result either from adverse storage conditions, or from otherwise beneficial drying in storage. Tables 10, 11, and 12 and the text accompanying table 13 give examples of partial dormancy from drying before storage.

Decision as to whether to treat any particular lot of seed for dormancy can best be made after the seed has been received and tested (p. 56). Varying degrees of dormancy are, however, common enough among seed lots in general to require facilities for treatment at all laboratories and most nurseries in which southern pine seed is tested or sown. Methods must therefore be selected and equipment obtained before operations start.

Stratification ²⁷

Although by no means infallible, stratification has worked better and has been more widely used with southern pine seed than has any other pregermination treatment. It was first applied to southern pine seed by Barton of Boyce Thompson Institute, in 1927 (82). Applied to seed lots handled by methods then in current use, Barton's techniques doubled the germination of most southern pine seed and reduced the period required for germination by approximately three-fourths. In both seed testing and nursery sowing, and to some extent in direct seeding, the treatment rapidly came into common use with many American conifers (11, 65, 66, 67, 68, 83, 84, 92, 398, 461, 465, 470, 485, 515, 596, 642, 711, 712, 736, 750).

The treatment depends for its success on keeping seed moist but aerated, at a temperature high

²⁷The term *stratification* was originally applied to outdoor storage of layers of hardwood seed between layers of moist sand in pits in the ground (778). Its application to the pregermination treatment described here, in which the seed may be mixed uniformly with the moist medium instead of being kept in strata, is incorrect (689), but is convenient and generally understood. Throughout this publication, *stratification* is used in the sense of pregermination treatment. Such stratification should never be mistaken for storage (461, 515).

ment of all lots. With many, treatment is unnecessary; with some, a simpler, cheaper treatment than stratification may suffice; with some, stratification does more harm than good.

This revised picture of need for and response to stratification was apparent in southern pine nurseries just before World War II. It was confirmed by paired tests of stratified and untreated seed from 18 longleaf, 114 slash, 66 loblolly, and 73 shortleaf seed lots, a total of 271 lots from many different sources. Stratification did consistently speed up germination of these seed lots, and in a few instances did bring about excellent germination of seed that virtually failed to germinate without it. With many samples of each species, however, and particularly of longleaf and slash pine, the gain in rapidity of germination was not great enough to justify the cost of treatment. In a fair majority of the tests, moreover, stratification, instead of increasing total germination, reduced it, often to four-fifths of that of the untreated seed, and sometimes to only one-fifth.

Neither nursery observations nor the tests just cited give any dependable clue as to when stratification is needed or when it will be harmful, beyond the fact that longleaf pine seldom requires it. Therefore, it is recommended that stratification be applied *only* to : (a) Seed lots that show a beneficial response to stratification in preliminary paired germination tests of stratified and unstratified seed (p. 63) ; and (b) loblolly and shortleaf seed sown in nurseries in which experience has shown that local conditions render seed of these two species consistently dormant. The same recommendations apply to soaking if that is substituted for stratification.

SEED TESTING

Efficient extractory or nursery operations are practically impossible without good, correctly timed seed tests (71, 242, 302).

Control of seed procurement and processing and of nursery sowing rate requires verification of species and geographic race by adequate records, and tests of : (1) Numbers or percentage of seed that contain kernels; (2) purity percent; (3) number of seeds per pound; (4) moisture content; and (5) germination percent. These tests need not all be equally precise. At several stages in seed handling, checks or simple tests serve merely to show that changes are proceeding in the right direction, or that seed meets some minimum standard of quality. With such simple tests, frequency and cheapness are more important than exactness—except that sampling must be dependable. Other tests—including practically all germination tests because of their importance in buying and sowing seed and in evaluating seed treatments—must be applied with scrupulous care to meticulously drawn samples.

Access to a specially equipped seed laboratory, with a professional staff (55), is preferable or

essential for the majority of germination tests, particularly at odd seasons and with certain inevitable freakish lots of seed. Without air-conditioned rooms or cabinets, uniform testing conditions are difficult to maintain from month to month and year to year even in such laboratories.

Some useful germination tests can, however, be made with less elaborate equipment at extractories or nurseries by following closely the recommendations in this bulletin. Other tests are preferably or necessarily made at the extractory or nursery (fig. 19). These include purity percent and percentage of full seed during cleaning, moisture content after kiln extraction or artificial drying or before storage, and numbers of seeds per pound after pregermination treatment. Numbers of full seeds per cone must be determined in the field.

Sampling

No seed test is more dependable than the sampling procedure by which the seed to be tested is drawn. For example, sampling without regard to the fact that empty seeds work to the tops of containers has resulted directly in 40 percent lower germination in the laboratory than in the nursery. Sampling which results in discrepancies less than half as serious as this nullifies the most accurate testing technique.

Sound sampling requires that:

1. *Seed be drawn at random from the mass to be sampled.* Every single seed in the whole lot, and every particle of impurities, should have as good a chance of being taken in the sample as any other seed or particle. There must be no personal bias in the choice of individual seeds or accompanying impurities, as to appearance, weight, position in the mass, or anything else that might affect the results of any test applied to the sample.

2. *Drawings be replicated.* The entire test sample must not be taken from one part of the seed lot. Instead, separate fractions ("subsamples") of the test sample must be taken from each of two or more different places in the main lot.

3. *Sampling be proportional.* That is, if natural subdivisions exist in the main lot, as by its being in several containers, subsamples must be drawn from each subdivision. If the amounts of seed in the containers differ, the numbers of subsamples from different containers must be approximately proportional to these amounts.

Sampling good enough for germination tests will be good enough for any other kind of test. Indeed, samples drawn for germination tests ordinarily serve also for determinations of purity percent and of numbers of seeds per pound, and portions of them may be used for moisture-content determinations as well.

Two methods of drawing samples for germination tests are in common use, one for small lots of seed and one for large lots.

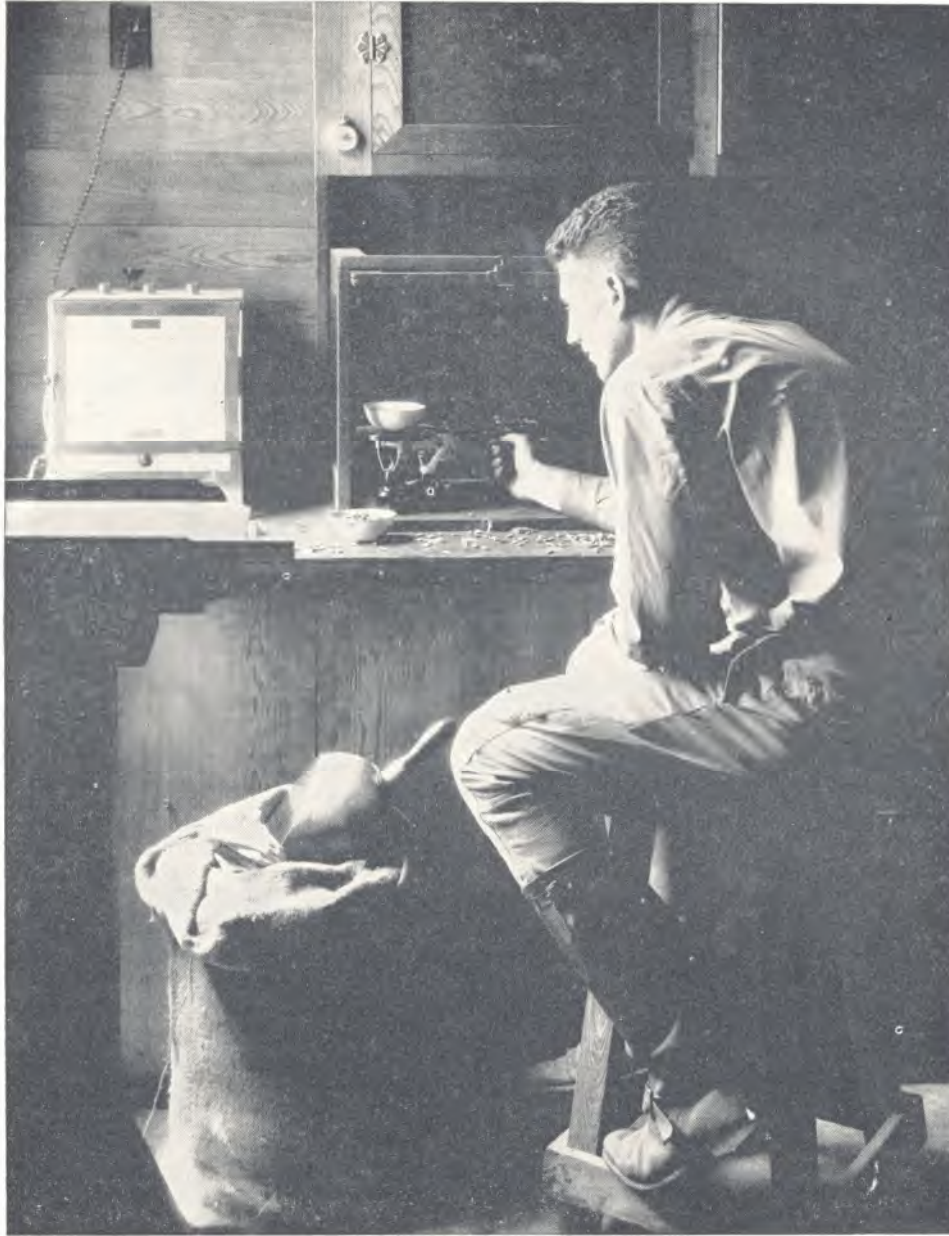

FIGURE 19.—Test of moisture content at U. S. Forest Service extractory, to make sure freshly extracted seed is dry enough for storage. Convection-type electric oven to left is used in determining moisture-free weight for calculating moisture content percent.

F-352955

The small lot method.—With small lots, the entire mass of seed to be sampled is poured out onto a sheet of paper, a smooth floor, or a tarpaulin, and mixed. The mixing takes care of all three requirements—randomization, replication, and proportional sampling.

The mixing must be thorough. It must be done by scooping or shoveling seed from side to side and from bottom to top of the pile. Shaking the seed in a container is worse than useless, because it moves large seeds, empty seeds, and seeds with wing stubs to the top. The best way to develop judgment of adequate mixing is to add about 5 percent of conspicuously painted and thoroughly dried seeds to the top of a pile and see how much

mixing it takes to distribute them uniformly throughout the mass. It takes more effort and time than inexperienced workers realize.

After the seed has been thoroughly mixed, it is built up into a symmetrical, conical pile, which is then flattened into a disk of convenient size and thickness. Approximately half the disk, if the lot is small, or a quarter if it is large, is laid off by eye and separated from the rest of the lot.

This half or quarter is then thoroughly remixed, and in turn heaped up, flattened, and halved or quartered. The process is repeated until the original lot has been reduced to the amount needed for testing.

The large lot method.—With large lots, a sample consisting of many subsamples is drawn from un-mixed seed in each of one or several containers, or, less frequently, is drawn from a pile of mixed or un-mixed seed without subdividing the pile.

It is recommended that, to avoid waste of time and effort, no samples from large lots be tested unless standards at least equal to the following have been observed in drawing them :

1. Minimum number of subsamples from the seed lot as a whole, 30 ; more if necessary as indicated under 2.

2. Minimum number of subsamples from each container, three—one each from the top, center, and bottom thirds of the container. The exact position from which each subsample is taken within each third should be varied as nearly as possible at random from third to third and from container to container, on the principle that all seeds shall have equal chances of being included. A conventional grain probe may be used to sample all species but longleaf pine, which requires a special probe (p. 217).

3. Minimum number of seeds for subsample, approximately 100, to provide a total of about 3,000 seeds for tests of purity and moisture content, and of germination both with and without pregermination treatment. If for any reason larger subsamples are used, they must be of uniform size.

4. When containers vary greatly in size, a minimum of three subsamples must be drawn from each of the smallest containers, and more from the larger in proportion to their size. For example, if part of a large seedlot is stored in 1-bushel and part in 2-bushel bags, 3 subsamples should be drawn from each 1-bushel bag, and 6 from each 2-bushel.

With fewer than 10 containers, the following numbers of subsamples are necessary :

Number of containers:	9	8	7	6	5	4	3	2	1
Numbers of subsamples from each:	4	4	5	5	6	8	10	15	30

These numbers must be adjusted somewhat if containers differ in size, but the total from the whole seedlot must be at least 30.

For purposes of sampling, a single pile of mixed seed should be counted as one container, and subsamples should be taken at 30 equally spaced points throughout the mass. Sampling from the catch-box of the fanning mill, for rough determinations of purity percent and percentage of full seed, is somewhat of a special case, for which 10 or even 5 subsamples may suffice.

With more than 10 containers, the number of subsamples will exceed 30, because at least 3 subsamples are required per container. With a large number of containers the total size of the sample (all subsamples combined) will be greater than necessary for routine tests and may amount to several dollars worth of seed. In such instances the "small lot" method (mixing, heaping, and quartering) is applied to reduce to workable size (3,000

seeds or slightly more) the total quantity of seed drawn by the large lot method.

Although most samples for determining percentage of full seed only, or purity percent only, should be drawn with the same care and refinement as samples for germination tests, there are two notable exceptions.

One is in examining cones for numbers of full seeds, during cone scouting or collection (p. 32). Mixing of cones or sampling from sacks of cones is ordinarily neither desirable nor possible. The requirements of random, replicated, proportional sampling are met well enough by taking one or a few cones from each of several trees, with the greater number from the sizes, ages, and forms of trees bearing the greater part of the crop.

The other common exception is in checking roughly the effectiveness of cleaning to standards (table 9, p. 43). It is often easier to draw samples from the discharge stream of the mill than from the mass of seed already cleaned. The only precaution necessary is to sample the entire cross section of the discharge stream. Any one part of the stream may carry a disproportionately high percentage of full seed, empty seed, or impurities. Catching the whole stream in any convenient fine wire tray or basket for a second or two at arbitrary, regular intervals usually gives adequate subsamples. The same method is even more convenient in sampling the trash discharge to make sure excessive sound seed is not being lost.

Sound sampling in accordance with these specifications, plus the equally necessary mixing of the sampled lot before sowing in the nursery (p. 75) costs little if any more than undependable sampling.

Percentage of Seeds That Contain Kernels

With southern pines, only pure seeds, as defined on page 60, are tested for fullness.

Percentage of full seeds is always calculated in terms of numbers, not weight.

$$\text{Percentage of full seed} = \frac{(\text{Number of pure seeds with kernels})}{(\text{Total number of pure seeds})} \cdot 100$$

Calculation of percentage full can be simplified by using 100-seed subsamples, with which the observed number of full seeds equals percentage full, or 25-seed subsamples, with which multiplying observed number of full seeds by 4 gives percentage full.

Within the limits of accuracy of the sampling method, the percentage of full seed shows the *maximum* germination percentage that can be attained by the seed lot. Whether the germination closely approaches this maximum, or falls considerably below it, depends largely on the previous treatment of the seed. Percentage of full seed may be used to determine rate of sowing (585), as described on page 74, but calculations based on actual germination percent are more reliable (66).

After final cleaning, before purchase, between stratification and sowing, and especially in examining the seeds left at the end of a germination test, cutting the seeds with a sharp knife, which also permits distinguishing sound from spoiled kernels, is the best way of finding out whether seeds are full. A soft board with 25 or 100 conveniently spaced dents to hold the seeds greatly simplifies both counting and cutting. Hard seeds like loblolly or small ones like shortleaf can also be cut conveniently on the sticky side of an adhesive tape.

When sound and spoiled kernels need not be distinguished, laying counted subsamples out on a hard, flat surface and smashing each seed with a hammer (85) is quicker than cutting. Full seeds crush into oily paste studded with bits of seed coat; empty ones into dry fragments. This is the preferred method for checking percentage of full seed during cleaning.

In "determining full seeds per cone to see whether cones are worth collecting or whether collection quotas must be increased, usual practice is to cut sample cones lengthwise with a sharp knife and estimate roughly the number of full seeds in each. Prying the seeds out of a few cones with a screwdriver or with long-nosed pliers ground to chisel points, cutting the apparently sound seeds, and comparing the numbers of full seeds with those revealed by cutting other cones from the same trees, is the best way of learning to make such estimates.

Purity Percent

Pure southern pine seed consists of all fully formed, apparently normal seeds regardless of whether they contain kernels. All dwarfed, malformed, pitchy, broken, and visibly cracked or wormy seeds are included with trash as impurities. This standard, though more exacting than that ordinarily applied to agricultural seed (737), is justified because it permits a more accurate forecast of seedbed germination than is possible if variable numbers of visibly injured seeds are assumed to be good. Detached seed wings are impurities, but wings or wing stubs that still adhere are included as parts of the seeds.

$$\text{Purity percent} = \frac{(\text{Weight of all apparently normal seeds in subsample})}{(\text{Total weight of subsample})} \times 100$$

These standards and this method of computing purity percent are essential to the rate-of-sowing formula on page 74. Calculation usually is carried to the nearest 0.1 percent. Balances accurate to 0.1 gram are sensitive enough with fairly large subsamples; balances accurate to 0.01 gram permit using smaller quantities of seed.

In buying seed or deciding on rate of sowing, purity percent is conveniently determined from samples drawn for germination tests. The germination test is then made with random subsamples of the pure seed segregated in determining purity.

For rough determinations of purity during cleaning, samples are usually drawn from the mill discharge (p. 59) or from the catchbox by the "large lot" method, but with only 5 to 10 subsamples instead of 30. The cleaning process should be adjusted until 5 to 10 successive subsamples taken at brief intervals give fairly uniform purity percents averaging at least as high as the desired standard. Sampling should be repeated frequently to see that the standard is being maintained.

For precise determinations of purity percent, 8 to 10 subsamples per seed lot should give a good average and a satisfactory estimate of reliability; 4 or 5 may be enough if the seed is very clean and has been well mixed. Ten-gram subsamples are about the minimum acceptable for well-cleaned shortleaf, loblolly, and slash pine seed, 15-gram for dewinged longleaf, and 20-gram for longleaf with wings intact. Subsamples double or triple these sizes may be necessary if balances accurate to only 0.1 gram are used, if only four subsamples are examined, if the percentage of impurities is high, or if large impurities such as cone scales are present.

Even for rough determinations, the weights of each of the four or eight subsamples used to compute *average* purity percent should be nearly identical. Averaging the purity percentages of subsamples differing greatly in size may seriously distort the average unless it is obtained by weighting.

Number of Seeds Per Pound

The common way of finding the number of seeds per pound is to divide 453,600 by the weight in grams (to the nearest 0.1 gram) of each of 4 or 8 random subsamples of 1,000 apparently normal seeds apiece. The subsamples are usually counted out from the pure seed segregated in determining purity percent. The subsample values are averaged to find the number of seeds per pound for the lot.

Four subsamples may be enough to show the reliability of their average if the individual determinations do not vary more than 2 or 3 percent in weight per thousand seeds, or if no very exact result is needed. Eight subsamples are needed if results are variable and a close estimate of the average for the entire seed lot is desired.

The 1,000-seed subsample is arbitrary. With good sampling and eight subsamples, 200- to 500-seed subsamples of any species are practically as reliable if weighed to the nearest 0.01 gram (0.1 gram for longleaf pine seed), and are far cheaper to count. The weights of subsamples of less than 1,000 seeds each are converted to seeds per pound by the formula :

$$\text{Number of seeds per pound} = \frac{(453.6) (\text{Number of seeds in subsample})}{(\text{Weight of subsample in grams})}$$

Since counting, and not weighing, is usually the main source of error or of excessive cost, it should

be done only by conscientious individuals provided with good light, comfortable temperature, and ample table space at comfortable height.

Seeds should not be counted singly, but in twos and threes to make tens. The number of tens should be verified before they are combined into piles of 100; in like manner, the number of piles of 100 should be checked before combining into subsamples of 200, 500, or 1,000 seeds. Alternatively, to save mental fatigue, seeds can be counted out by sliding them onto any desired number of small spots, on stiff paper.

Moisture Content

Seed moisture content is most conveniently expressed as a percentage of the *oven-dry weight* of the seed, calculated by the formula :

$$\text{Moisture content percent} = \frac{(\text{Original weight}) - (\text{Oven-dry weight})}{(\text{Oven-dry weight})} \cdot 100$$

Moisture content percent is almost invariably based on random subsamples of seed plus accompanying impurities. It is usually recorded to the nearest 0.1 percent.

Authorities differ as to the best method, direct or indirect, for determining seed moisture content (71, 84, 714). The Southern Forest Experiment Station dries subsamples in electric ovens maintained at 101° to 102° C. (about 214° to 216° F.) by thermostats. Convection-type ovens (fig. 19) cost less than forced-draft ovens, but the latter dry seed more quickly and may be preferable where the moisture contents of many seed lots must be determined almost simultaneously to insure optimum storage.

The subsamples are oven-dried until repeated weighings show no appreciable further loss in weight. Such drying usually takes 4 to 12 hours, rarely 16 to 24. Drying is quicker in wire containers than in glass, tin, or paper. The process should not be continued beyond the attainment of constant weight lest chemical changes in the seed result in further reduction of weight not due to loss of moisture.

Since moisture content determinations involve no separating, counting, or cutting of seeds, increasing the size of the subsample adds to the cost mainly by using up more seed. For most seed lots, subsamples should weigh 20 to 100 grams apiece. Ten grams should be a minimum even with small seed lots; subsamples of 200 grams (not quite one-half pound) apiece may be desirable with seed lots weighing several hundred pounds. At least two subsamples should be tested from each seed lot. Four to eight are preferable for lots of several hundred pounds, or for any lots the moisture contents of which must be known precisely.

As the moisture contents of small quantities of seed change very rapidly in response to atmospheric humidity, the original weights should be

recorded immediately after the subsamples are drawn from the main seed lot. The only workable alternative is to seal the subsamples in separate jars, with a minimum of air space, until weighings can be made.

Germination Tests

To date, direct tests have proved by far the most generally feasible and reliable means of learning the germination percent of southern pine seed. Indirect tests which depend upon dissecting or cutting and staining the seeds or employ other rapid methods (71, 200, 239, 253, 254, 300, 515, 578, 638) have not been adapted to large-scale differentiation of living from dead southern pine seeds or to the differentiation of normally from abnormally germinating seeds.

A direct test of the germination of southern pine seed must provide correct amounts of four things—moisture, oxygen, warmth, and light. No seed can germinate without the first three. Some lots of southern pine seed can germinate without light but, since many require light for optimum germination (fig. 20), the only safe rule is to provide light for all. Inadequate moisture and excessive temperatures probably are the most frequent causes of poor germination of test samples, but some of the most serious failures have resulted from testing in dark chambers or under covering which light could not penetrate.

It is recommended that for each seed lot, regardless of size, germination be recorded separately for 8 subsamples of 100 seeds apiece. This procedure insures the minimum dependable samples for large lots, together with the most useful analyses of results (pp. 64-65) from all lots.

The medium on or in which the subsamples are tested is the principal means of controlling the moisture and oxygen supplied to the seed. Both fine quartz sand and compressed mats of granulated acid moss peat have given better results with southern pine seed than have filter paper, blotting paper, paper towels, sawdust, porous clay plates, soil, and mixtures of sand with soil or peat.

Sand flats versus peat mats.—Sand requires less skill and less special equipment than peat mats, and may be easier to get. It is safe if uninfected with damping-off or other harmful fungi and if kept moist, but must be sterilized with formaldehyde (p. 210) or by washing thoroughly with water at 158° F. or higher (236) if infection is found or suspected. Even in inexperienced hands, sand-flat tests are likely to forecast nursery germination reliably because seeds germinating weakly or abnormally usually fail to emerge from the sand (242). The chief disadvantages of sand are its weight, the difficulty of keeping it at optimum moisture content (flats must be watered at least once a day), and its tendency (unlike peat moss) to get into laboratory apparatus. Sand is best used in greenhouses or special germinating rooms.

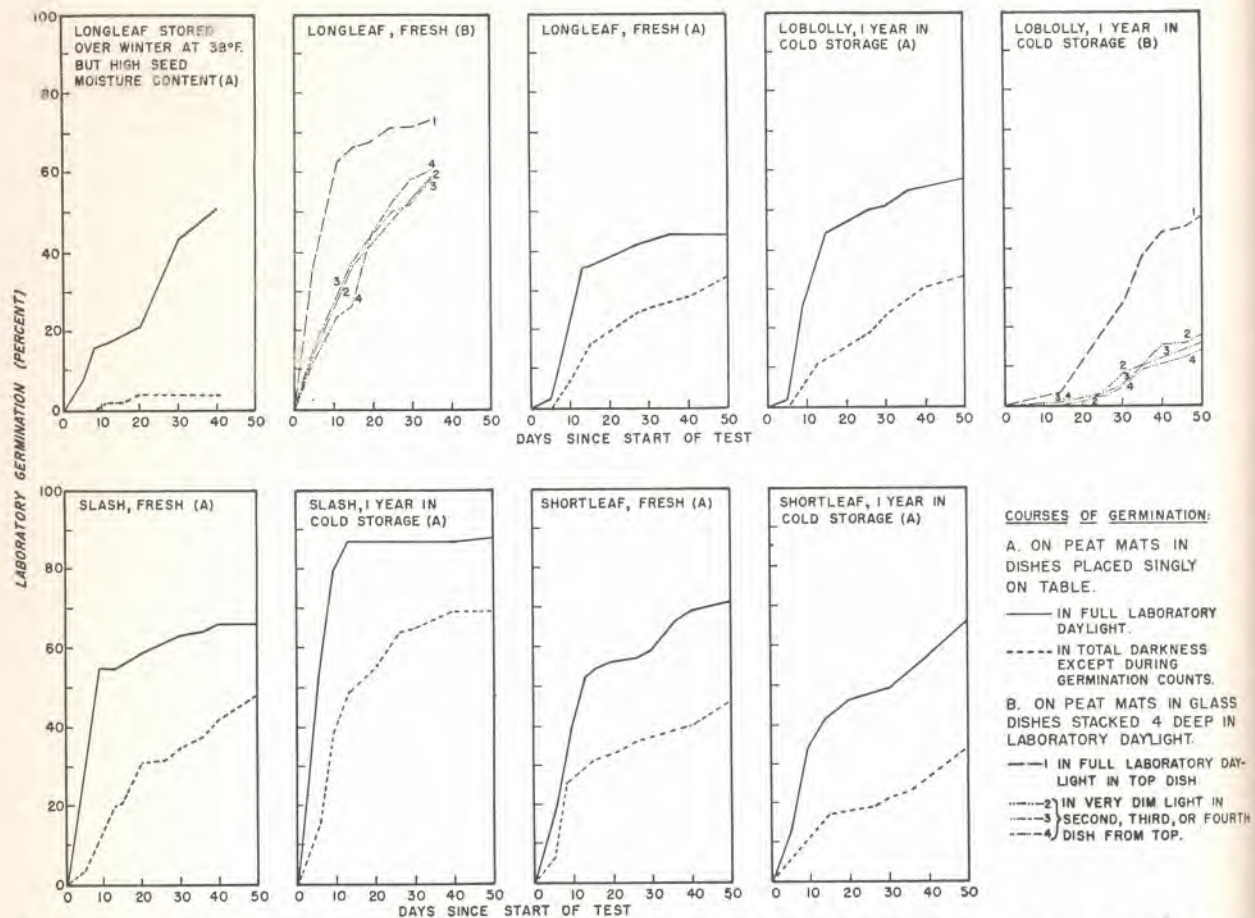

FIGURE 20.—Germination of southern pine seeds in total darkness or dim light, contrasted with that in normal diffuse daylight.

Sand may be used in flower pots (236), but shallow, square "flats" save table space.

Granulated acid peat is superior to sand in many ways, especially when economies of labor and space are important (74.9, 750). Its greatest advantage is the ease with which correct moisture is maintained. Once well established, peat mats seldom require watering more often than every fifth to tenth day. Peat-mat tests, however, require more training and experience to distinguish abnormal germination than do sand-flat tests.

Detailed directions for setting up and conducting sand-flat and peat-mat germination tests are given on p. 217. Either flats or mats will maintain very nearly ideal moisture conditions and oxygen supply if these directions are followed exactly.

Temperature and light for germination tests.—Of the temperatures suggested in table 15, those for longleaf pine have been most thoroughly substantiated. In nature, longleaf seed germinates in November and December. During stratification in the refrigerator, longleaf has germinated gradually at 41° F. and fairly rapidly at 50° and 59° (82). It germinates readily at 60° to 75° but very

poorly at temperatures continuously above 80° (450), and wide experience has shown that even a few brief periods above 80° may delay, reduce, or prevent germination.

The principal means of controlling temperature and light is by selecting the proper room or incubator in which to place the sand flats or peat mats. However, sowing seeds too deeply in sand, or placing peat mats one upon another (fig. 20) may nullify the effect of good light. The other southern pines germinate better than longleaf at temperatures slightly above 80° F., and their germination may be retarded or prevented by low temperatures at which longleaf germinates well. So far as is known, seed of any southern pine benefits by some day-to-night fluctuation in germinating temperatures.

Temperatures considerably higher or lower than optimum probably account for some of the inconsistencies in long-time storage tests, in which an additional year's storage has seemed to improve the quality of the seed (tables 11 and 12) (84, 515, 604). The same unsuitable temperatures that have caused inconsistent germination of stored seed must also have distorted the results of some ge,

nation tests made as guides to nursery sowing. Such difficulties can be overcome only by learning the optimum germinating temperatures of all species and maintaining them during the germination tests (76).

TABLE 15.—Suggested temperatures ¹ for germination tests of southern pine seed

Species	Recommended limits		Assumed best	
	Minimum	Maximum	Constant	Fluctuating
	° F.	° F.	° F.	° F.
Longleaf	40	80	70	60-75
Slash	55	85	75	65-80
Loblolly	50	85	75	65-80
Shortleaf	45	85	75	60-80

¹ Measured in the air just above the germinating medium. Evaporation from the surface of the medium usually cools the seed to a level slightly below that of the air.

Eight or ten hours' exposure each day to normal diffuse daylight (bright enough for reading fine print) gives southern pine seeds in correctly sown sand flats or on peat mats all the light they need. Exposure to equally intense electric light from either incandescent or fluorescent bulbs, for like periods, apparently gives just as good results. The lower limits of safe illumination are not known, but must vary considerably as some lots germinate less well in dark corners than near a window, whereas occasional lots germinate satisfactorily in total darkness. Direct sunlight dries out sand flats too fast and makes dark-colored, glass-covered peat mats dangerously hot.

Injuries and abnormalities.—Some mold invariably develops in tests on peat mats—it starts on dead and empty seeds—but usually may be disregarded (251). Special techniques to control mold (41) are not necessary with southern pine seed of reasonably high vitality. Sterilization of the seed with calcium hypochlorite, sometimes recommended, may do more harm than good (684).

The larvae of fungus gnats sometimes attack first the mold and then the seeds in peat-mat tests, and seeds in sand. This ordinarily occurs only when temperatures are unfavorably high, and mostly in greenhouses open to outside air. On peat, the maggots seldom harm the germinating seeds until they have eaten most of the mold.

Germination may be abnormal, usually as a result of injury during extraction, dewinging, or storage (242). In sand flats, seeds germinating abnormally seldom appear above the sand, but on peat mats care must be taken not to confuse them with normally germinating seeds. A few southern pine seeds contain two or more embryos, of which one is usually normal in size and the others dwarfed, though occasionally there are two of

normal size (544). Instructions for recognizing and recording normal, abnormal, and polyembryonic germination are found on p. 222.

Scheduling germination tests.—Tests must be started early enough to allow time for complete or nearly complete germination before the date of sowing, yet not so early that the main lot of seed will have time to deteriorate or become dormant between testing and use. The viability of good, correctly stored seed ordinarily remains constant for the periods required for testing by the techniques described—usually 25 to 35 days with non-dormant seed and 40 to 50 days (including 20 to 30 days' stratification) with dormant seed.

With the exception, usually, of longleaf pine, scheduling of germination tests for calculating sowing rates is complicated by the possibility that any seed lot may require stratification before nursery sowing, but that the need for such treatment cannot be recognized in advance of germination tests (p. 56). The problem introduced by stratification is solved by starting tests 45 days before the contemplated dates of sowing, and reporting results as scheduled in table 16.

TABLE 16.—Approximate schedule, in days after receipt of seed, for paired germination tests of untreated and stratified seed, to determine sowing rates

Steps	Comparable parts of sample	
	Tested without stratification	Stratified before testing
	Days	Days
Part of sample stratified		1
Germination test started	1	30
First report to nurseryman	¹ 15-18	40
Second report to nurseryman	25-30	45
Final report to nurseryman ²	40-50	50-55

¹ If low germination suggests seed is dormant, nurseryman should be advised immediately to stratify lot from which sample was drawn.

² With results of cutting test of ungerminated residue.

Some germination tests for special purposes must be scheduled independently of sowing date. Tests designed to forestall or eliminate injuries to seed during extraction and dewinging, for example, must be started at intervals during these processes (p. 42). Seed lots to be stored for long periods should be tested by means of samples, both stratified (except possibly with longleaf pine) and unstratified, drawn a week or less before placing the lots in storage. Other samples may be drawn annually to see how the seed is keeping. August or September tests of stored seed are highly desirable as guides to collection of fresh seed, but because of the temperature requirements (table

15) cannot be made in the South without temperature control facilities. None of these special-purpose tests can ordinarily be substituted for those made to control sowing.

Reporting and Interpreting Results of Seed Tests

The report of any seed test should be explicit and detailed enough to permit duplication of the test by a competent technician (401).

The report should include sampling method, size of sample, number and size of subsamples, testing technique used, and results separately by subsamples. The report of a germination test should record also the arrangement of subsamples in sand flats or other apparatus (for use in statistical analysis) and duration and calendar dates of test, as well as nature, duration, and calendar dates of any pregermination treatment applied. In well-standardized work, such records may be shortened by explicit references to written specifications kept in accessible files and followed exactly in testing. When techniques are varied from sample to sample, they should be recorded individually in the reports.

Omitting any of the foregoing details may make test records very misleading. Many a sparse seedbed has resulted from sowing partly deteriorated seed at a rate computed from an undated record of germination thought to be recent but actually determined when the seed was fresh. Other lots of seed have been similarly overrated because high percentages of seed have been reported as "good" without noting that the percentages had been determined by hammer test instead of by actual germination.

The interpretation of germination tests usually involves one step beyond the simple averaging of subsample results required in all seed tests. This step is deciding the extent to which the observed germination may be effective in nursery practice. In southern pine nurseries, germination is effective only if it takes place within a short period—generally 2 or at most 3 weeks—and is most effective if this period begins very soon after sowing. If germination takes long to start, the seed is unduly exposed to birds and to preemergence damping-off. If germination, once started, is spasmodic and long drawn out, the first seedlings to emerge are likely to be smothered by the seedbed cover (especially a cloth cover), and the last, to succumb to drought or heat after the cover has been removed.

The easiest and most practical way of judging effective germination from the test of a representative seed sample is to note the "shoulder" at which the curve of total germination flattens off after a rapid rise (fig. 21). Germination taking place after the curve has begun to flatten off may be discounted; any trees resulting from such belated germination will be too few to crowd the beds.

Seeds germinating abnormally should be excluded from the curve, as they almost never produce trees.

If the seed was of high viability and was non-dormant (either naturally or from pregermination treatment), germination will have started and ended rather abruptly. In such instances the shoulder of the germination curve is conspicuous, and marks plainly both the level of effective germination and the days required to attain it (fig. 21, *A*, *B*, and *D*). After a preliminary delay, even dormant seed may have exhibited moderately quick germination which terminated abruptly enough to permit a shrewd estimate of effective germination (fig. 21, *C*). In either case, the presumption is that germination in the nursery will parallel that in the laboratory (p. 74), though perhaps at a somewhat lower level because of less uniformly good germinating conditions in the seedbed (p. 50).

If germination during testing was spasmodic or long drawn out, the germination curve may show no distinct shoulder (fig. 21, *E*). In such an event, more elaborate calculations of "germination energy," although possible (71, 718), seem of doubtful value. Indeed, it may be questioned whether the seed, in the condition in which it was tested, was capable of effective germination.

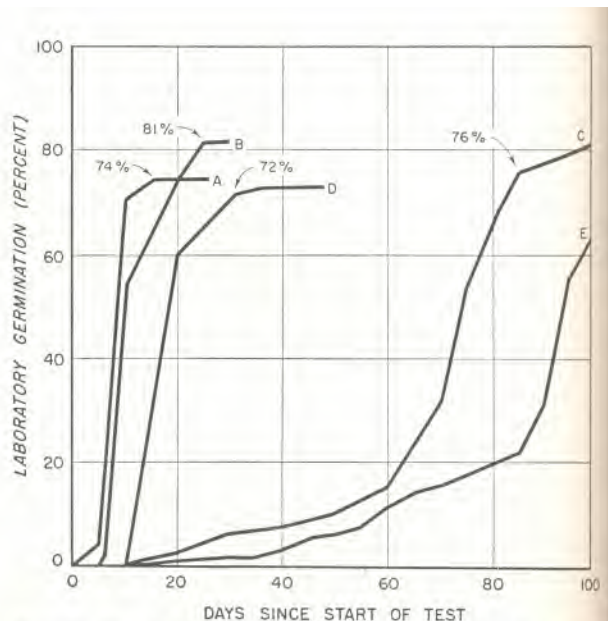

FIGURE 21.—Percentages of effective germination indicated (where recognizable) with arrows on curves of total normal germination. *A*, unstratified longleaf seed; *B* and *C*, initially dormant slash seed, stratified and unstratified; *D* and *E*, initially dormant loblolly seed, stratified and unstratified, respectively.

Curves of total normal germination over days of record are most easily plotted from germination recorded as recommended on page 222. An experienced seed tester or nurseryman can often determine effective germination merely by inspecting the laboratory record.

The germination of a seed lot in the nursery seldom is exactly the same as that of the corresponding test sample. For this reason, the usefulness of the germination test may be greatly increased by calculating the upper and lower limits between which the germination percent of the main seed lot is likely to fall. These limits may be used to estimate the maximum and minimum numbers of seedlings per square foot that are likely to result from any given rate of sowing in the nursery. It may also be important to know whether the difference between the average germination percentages of two test samples is attributable to differences in seed treatment, or to chance. Comparisons of this kind are invaluable in developing improved methods of extraction (596), dewinging and cleaning (242), and storage.

Questions of the first of these two types may be answered by calculating "fiducial limits" (288, 556, 676, 713); those of the second type by "rank-analyses" (778, 779) or analyses of variance (288, 556, 676, 713). For most sensitive results, each observed percentage of germination may have to be "transformed" (81; 676, pp. 445-450) before the calculations are carried out.

In connection with such calculations the following points require emphasis: (1) Recording germination separately by equal numbers of equal-sized subsamples in all germination tests greatly simplifies the analyses; (2) without a standardized design of all germination tests, the analyses may be impossible; and (3) the analyses will not be valid unless the samples tested have been drawn both representatively and at random from the original seed lots. For these reasons, and because it is impossible to know ahead of time which test results may require statistical analysis, the sampling procedures on pages 57-59, the use of 8 subsamples of 100 seeds each in all routine germination tests, and the detailed records described on page 222 are recommended.

SEED COSTS, PURCHASES, SALES, AND RECORDS

Southern pine seed costs are so variable that averages have little meaning. Over a 5-year period before World War II, southern pine seed cost the U. S. Forest Service from \$0.21 to \$2.72 per thousand trees planted, and made up from 3.4 to 18.6 percent of the total cost of planting (table 6, p. 24). Prewar prices per pound, at different times and places, ranged from \$0.22 to over \$25.

The extent of the market for seed is also hard to describe. About all that can be said is that just before World War II the U. S. Forest Service alone used at least \$40,000 to \$50,000 worth of southern pine seed a year (12, 190, 291); that postwar demand by all agencies in the southern pine region has risen to \$150,000 worth a year, or more; and that foreign demand has been considerable and seems likely to remain so (483, 639, 721).

Planting the Southern Pines

Costs

With even moderately good equipment and technique, extraction and cleaning costs are fairly constant. They can be kept low; in efficient plants, before World War II, these costs together seldom exceeded 30 to 50 cents a pound, including depreciation of buildings and equipment. Exact data are scanty, but indicate that from 60 to 95 percent of the total cost per pound is for collection, including transportation. Seed cost accounts that itemize scouting, collection (or purchase), shipment, extraction, and cleaning, and any subsequent storage, pregermination treatment, and recleaning where these are necessary, are the most useful guides to reduction of total cost per pound.

In the final analysis, however, cost of seed per thousand trees produced, rather than cost of seed per pound, is the proof of economical seed collection, extraction, and storage. Seed collected at low cost in a good seed year and maintained at a uniformly high level of vitality by cold storage at low moisture content may cost considerably less per thousand trees planted (even allowing for storage charges) than fresh seed collected at high cost in a poor seed year. The opposite may be equally true; cheap seed weakened by poor storage may cost far more in the end than fresh, vigorous seed collected at high prices. At comparable high levels of vitality, small seed at a high price per pound is cheaper than large seed at a low price. For example, the average cost per pound of shortleaf seed shown in table 6 doubtless was considerably higher than that of longleaf seed, but the average cost of seed per thousand trees produced was only a third as much.

Because it costs more per thousand to water, weed, spray, and lift seedlings in sparse stands than those at normal seedbed density, seed injuries, by reducing the density, frequently increase nursery costs per thousand trees as they do outlay for seed also (fig. 11, p. 29). Any minor saving in labor, supervision, or equipment at the expense of seed vitality is therefore false economy.

Buying and Selling Seed

The principal American users of southern pine seed have been Federal and State agencies and large industrial concerns. They have obtained seed in various ways and have often changed methods from year to year. The result has been an unorganized and erratic seed trade, which has been unable to make full use of existing technical knowledge.

Decentralization of seed collection is essential to meet the needs for local seed for the innumerable planting programs scattered throughout the southern pine region. Decentralization can be attained with greatest benefit to all concerned by developing a steady trade with local collectors. Conscientious, well-informed men living in the

many areas from which seed is wanted, and collecting cones year after year, can supply seed of more suitable geographic races than can collectors concentrated in a few places only. Usually with substantial profit to themselves (123), they can supply it at lower cost than can inexperienced local crews hastily recruited by some outside agency or flying squadrons sent into collecting grounds from a distance.

Experience both in the South and elsewhere (72) has shown that local collection of cones is encouraged by : (a) Planning of planting, and of the necessary seed procurement, for several years in advance, so that advantage can be taken of abundant seed crops; (b) systematic purchasing from considerable numbers of local residents whenever cone production permits collecting at reasonable cost ; and (c) full use of forestry and extension field organizations to bring collectors and purchasers together and to inform collectors concerning techniques. Development of small, cheap, dependable extracting plants would also improve the seed trade by enabling more local collectors to extract seed effectively from the cones they collect.

General agreement as to maximum moisture contents (pp. 41 and 53) and minimum purity and full seed percents (table 9, p. 43) at which seed should be weighed, stored, shipped, and sold would also benefit the seed trade.

Six of the most prolific sources of trouble in selling or buying cones or seed are :

1. Speculative collection (that is, without orders in advance) in excess of assured markets.

2. Failure of the buyer to make clear that an inquiry concerning quantities or prices of cones or seed is not an order.

3. Placing of orders during or after, instead of well before, the collection season.

4. Deterioration of cones through delayed or improper shipment (p. 36).

5. Failure of the buyer to specify the *maximum* quantity of cones or seed he will accept at a specified price. (This sometimes leads collectors to deliver many times the quantity the buyer can accept, and his refusal invariably leads to hard feelings.)

6. Weighing seed without considering its moisture content. Under extreme conditions 100 pounds of longleaf pine seed shipped at a moisture content of 35 percent may dry to 8 percent in transit and hence weigh only 80 pounds on arrival. Smaller losses of weight than this may jeopardize business relations if the cause is not understood.

These and other difficulties can be avoided by entering into a written contract for cones or seed after the collector has scouted for cones but before the collecting season has opened. Trouble can be avoided by never collecting from another's land without first getting written consent. Some agencies require proof of ownership before they will accept delivery of cones.

A contract for cones should state plainly :

- a. The species, quality, and cleanness of cones that will be accepted ; locality of collection ; degree of maturity to be attained before collection; and care to be given cones until delivery.

- b. The unit of measurement. Sale by the bushel of unopened cones is much fairer than sale by weight, since weight changes rapidly during the collecting season.

- c. Price per unit and time of payment. Often it is desirable to pay for cones weekly or biweekly, to enable the collector to pay his crew. The contract should also specify who is to furnish, pay for, and keep the bags.

- d. Point of delivery, and frequency of shipment by collector or of pickup by buyer (at least once a week, and preferably oftener, to prevent deterioration in the sacks).

- e. Time and place of inspection, persons to make the inspection, and bases for accepting or rejecting cones.

- f. Largest quantity the buyer will accept at the contract price. A penalty clause for nonfulfillment of the contract by the collector may also be included, but because of the difficulty of estimating accurately the quantity of collectible cones the clause should not force delivery of more than half the amount of cones specified in the contract.

- g. Minimum label on each container—species, locality, and exact period of collection.

A minimum contract for seed should state :

- a. Species, geographic source, year of collection, treatments applied, and minimum percentages of purity and of full seeds at time of delivery.

- b. Unit of measurement (usually pounds), and at least approximate moisture content at which seed is to be weighed.

- c. Price per unit, point and time of delivery, time of payment, and payer of shipping charges.

- d. Largest quantity the buyer will accept at contract price.

- e. Minimum label on each container—species, lot number, locality of collection, exact period of collection, method of extraction, storage conditions, and beginning and ending dates of storage. These minimum entries on the label are the indispensable basis for certain nursery and plantation records and for any system of seed certification (70, 72, 431, 643).

Prices for cones and seed may be difficult to set in advance of collection and extraction. In inviting or submitting bids, or entering other phases of bargaining, a feasible approach is to make the closest possible estimate, step by step, of the actual cost of the work, and then add 20 percent to the total for profit and risk.

Although they seem obvious, experience has shown that the following require emphasis. Warranty of species depends not only upon the integrity of the vendor, but also upon the training and integrity of his collecting crews. Warranties of species, geographic source, and date of collection involve not only adequate and accurate

labeling, but also careful warehousing. The validity of germination percent statements depends upon the competence and facilities of the laboratory technician as well as the adequacy and soundness of sampling (p. 57).

If the buyer does not wish to rely solely on the vendor's ability or integrity for a statement of seed quality, the contract should specify how, when, where, and by whom the seed is to be sampled and tested, and what adjustment in price is to be made in the light of the test results.

Extracted seed is sometimes purchased from local collectors who lack good cleaning facilities. Such purchases are sometimes made on the basis of the weight after recleaning to specified standards. If so, the standards to which the seed is to be recleaned, and provision for inspection, sampling, and weighing, should be written into the contract.

A public agency buys cones or seed, or collects cones by contract, under regulations or restrictions peculiar to the individual agency. Any such restrictions should be fully explained to the vendor or contractor in writing. Vendors and contractors should inquire about restrictions before closing deals with public agencies.

Seed of longleaf, slash, loblolly, or shortleaf pine bought or sold in the State of Georgia must,

with certain exceptions, conform to the Georgia Seed Law (footnote 10, p. 16) .

Since even brief exposure to high temperatures and humidities during shipment may significantly reduce the vitality of seed, the precautions described on page 52 should be observed in shipping seed into or across the tropics.

Records

Seed records should include : Species; lot number; geographic source (State and county or ranger district, with elevation above sea level where it exceeds 1,000 feet, and whether the seed came from a natural stand, a plantation of specified seed source, or a plantation of unknown source) ; date of collection; method and period of extraction; extent and method of cleaning; yield of clean seed per hushel ; germination percent and moisture content when stored ; temperature, humidity, container, date, and duration of storage ; and germination percent when removed from storage. Usually needed only when attempting to improve seed-handling techniques are records of : Abundance of cone crop; yield of uncleaned seed per bushel ; percentage of weight lost in cleaning; and the method and effect of pregermination treatment.

NURSERY PRACTICE

Large-scale production of southern pine planting stock (fig. 22) is expensive and exacting. Selecting a nursery site requires great care. Sowing, watering, weeding, lifting, culling, grading, packing, and shipping all require close attention to detail. Control of the many troubles from which seedlings suffer requires constant watchfulness, prompt diagnosis, and precise technique. Few if any crops demand more careful soil management or are harder on the soil. The following pages summarize general information on these problems, but for many essential facts the nurseryman must depend on his own library.²⁸

The requirements for buildings and equipment vary so much from nursery to nursery, and both agricultural and special nursery equipment are being improved so rapidly, that it is impracticable to describe them in detail. The minimum requirements include tractors, trucks, plows, harrows, and hand tools ; a bed shaper, a pine seeder, and bed-cover layers and removers; often a separate seeder for soiling crops; perhaps a manure spreader ; always an overhead sprinkler system and a power sprayer, seedling lifters and balers, and frequently a conveyor-belt grading table; often a seed extractory and cold storage plant; usually residences, equipment sheds, and an office ; and always a good fence. The county agricultural agent can usually suggest power requirements and type of plows and harrows for local soils. Up-to-date specifications for special appliances may be obtained from the Regional Forester, U. S. Forest Service, Atlanta, Ga.²⁹

²⁸ In addition to current files of the American Nurseryman and the Journal of Forestry, the following are suggested for the library of a large, permanent nursery: (a) general texts (718); (b) seed references, including (71, 596, 735); (c) references on machinery and equipment, like farm implement catalogues and (671, 725); (d) references on insects and diseases, including (46, 198, 223); (e) soils references, including (437, 732, 753); (f) texts on fertilizers, like (52); (g) texts on statistics, like (676), and on sampling (636); and (h) the latest bulletins and circulars of the U. S. Department of Agriculture and State experiment stations on cultural practices, soils, fertilizers, composts, green-manure crops, insects, and disease.

²⁹ The following references, in addition to implement catalogues and various State agricultural experiment station publications, contain useful information about equipment: (42, 114, 189, 298, 305, 343, 350, 413, 443, 455, 553, 587, 599, 704, 718, 725, 731).

NURSERY SITE AND LAYOUT

No step in artificial reforestation requires more care than does selecting the site for a permanent nursery. Good nursery sites are likely to be superior, high-priced farmland. Experience has shown, however, that buying a good site may cost far less than correcting unsuitable conditions on a poor one.

Location

A central location within the territory served by the nursery minimizes stock-shipping costs. If the territory is large, however, a location well north of its center may be necessary to keep seedlings from resuming height growth in the beds before the planting season is over at its northern edge.

Access to water, main highways, labor, express and freight facilities, telephone, electric power, and cold storage, as well as to medical, school, and similar facilities for the nursery staff, is important.

Localities of serious insect and disease hazard, including sites infested with harmful soil fungi or nematodes, should be avoided. Determination of soil insect, fungus, or nematode infestation usually requires not only field examination but also laboratory and greenhouse culturing (803) and a thorough study of the past history of the site; the State agricultural experiment station may be the logical agency to do the culturing. The existence of quarantine lines that will prevent shipment of stock should be checked with both the U. S. Bureau of Entomology and Plant Quarantine and the State plant board (p. 214) before the nursery is established.

Capacity

To insure against unforeseen losses, the total area of seedbeds and paths allowed for a given number of seedlings should be about 20 percent greater than the net area required (table 17) at the desired seedling stand density. This total must, in turn, be doubled if soil-improving crops are to be alternated annually with seedlings.

Space must be allowed for roads and buildings, and for increases in the seedbed area if the planting program expands. Control of a few acres of fairly severe planting site adjacent to the nursery aids greatly in field testing debatable nursery treatments.



FIGURE 22.—A permanent State nursery producing 20 million or more southern pine seedlings per year.

Water

A prime need is a dependable water supply, large enough to lay down the equivalent of 4 or 5 inches of rainfall a month over the entire area likely to be used for pine seedlings in any one year. The rate of flow must be sufficient to apply one-half inch over the entire seedbed area in 12 hours or less. Five inches of water on 1 acre—ordinarily the minimum area to produce a million seedlings—requires 136,000 gallons. Residences, shops, and the fire protection system require additional amounts.

Water carrying 500 parts of calcium per million is dangerously likely to raise the pH concentration of nursery soil and to increase damping-off, root rot, and chlorosis; water carrying 100 parts of CaCO₃ or 125 parts of calcium bicarbonate per million may do so (58, 160, 223, 224). Usually, however, water from streams running wholly within the southern pine types is safe so far as calcium is concerned. Water with a high silt or colloidal content may seal the soil surface, reduce soil aeration, and predispose seedlings to disease, and the water itself may carry disease organisms (203). Sediment or algae in the water may clog sprinkler nozzles. No nursery should be estab-

TABLE 17.—Areas¹ required for 1,000,000 seedlings at different combinations of bed and path width and seedling stand density

Seedlings per square foot	3-foot beds		4-foot beds		5-foot beds	
	2-foot paths	1½-foot paths	2-foot paths	1½-foot paths	2-foot paths	1½-foot paths
20	1.91	1.72	1.72	1.58	1.61	1.49
25	1.53	1.38	1.38	1.26	1.29	1.19
30 ²	1.28	1.15	1.15	1.05	1.07	.99
35	1.09	.98	.98	.90	.92	.85
40	.96	.86	.86	.79	.80	.75
45	.85	.77	.77	.70	.71	.66
50	.77	.69	.69	.63	.64	.60

¹ Including beds and the paths separating them, but not roads, cross paths, or width added to paths along sprinkler lines.

² Practicable average density on most nursery soils.

lished until analysis by the State agricultural experiment station or other qualified agency has shown that the available water is free from, or can readily be freed from, all such harmful sub-

stances and organisms. It is well also to test the water throughout a full growing season in advance of nursery establishment, both to see whether regular applications increase the pH concentration of the top one-quarter to one-half inch of soil over that of soil 3 inches down and of topsoil in unwatered plots (223), and to learn their effect on seedlings in plots or pots.

Topography and Soil

Sites with excessive surface drainage and erosion should be avoided. Ordinarily the slope of the seedbed area should nowhere exceed 2 or 3 percent, yet the site must not be absolutely flat lest water stand after rain. Subsurface is as important as surface drainage; "crawfish" land is unsuitable for pine nurseries. Land subject to overflow is useless.

The soil should be uniform in depth and texture as well as in slope. The best nursery soils are fine to coarse sandy loams, underlain at 18 inches or slightly more by somewhat stiffer but still permeable subsoils. A stiff subsoil less than 12 inches below the surface is very undesirable.

Soils containing not less than 15 nor more than 25 percent by weight of particles smaller than 0.05 millimeter in diameter are recommended. Such particles generally remain suspended in water after the soil has been mixed with water (shaken hard 60 times in a partly filled flask) and allowed to stand for 60 seconds, while larger particles settle out within that time (781); more accurate special techniques and apparatus are also available for these measurements (783). The lighter soils are better drained and easier to work and (341, 408, 739) permit better seedling root development than heavy soils. Extremely light, loose, sandy soils, low in organic matter and with poor moisture-retaining capacity—wilting coefficient less than 4 percent (223)—*should*, however, be avoided, as should those that are easily eroded by wind or water, that puddle, cake, or crust after wetting, or that contain much stone or gravel.

The pH concentration of the soil should not be above 6.5, lest the seedlings suffer from damping-off, root rot, and chlorosis; nor below 4.5, lest mineral nutrients be rendered unavailable to the seedlings (7, 223, 302, 780, 783).

The mineral nutrient level of nursery soils should be at least as high as that required by agricultural crops grown on former pine land, and should be capable of easy maintenance and improvement. The great weight of plant tissue per acre produced by southern pine seedlings when grown at ordinary seedbed densities, together with its practically complete removal during lifting, makes the annual drain of pine seedling crops upon soil nutrient material severalfold that of cotton or corn.

It is thought that the organic content of nursery topsoil should not be below 1.5 percent, preferably not below 2.5 percent.

The presence of abundant mycorrhiza-forming fungi (p. 82) in the soil appears desirable, but can ordinarily be counted on anywhere within the southern pine types.

Other things being equal, weedy areas should be avoided, especially those infested with Johnsongrass, Bermudagrass, or worst of all, nutgrass (cocograss). Luxurious weed growth, however, usually indicates high soil fertility, and meager weed growth, low fertility.

The soil is the hardest thing about a nursery site to evaluate. The only reasonably dependable way is to grow several small trial beds of seedlings for 1 and preferably for 2 years before the site is developed (223, 302). At least one such test crop should be outplanted on average to fairly severe sites to see how the seedlings survive the first year.

Nursery Layout

Utmost care should be taken to lay out beds correctly when the nursery is established. Changes made later to improve drainage, control erosion, or reduce operating costs may necessitate placing beds on or across former paths where the soil has become so firmly packed that several years of subsequent cultivation and fertilization will fail to restore full productivity.

A combination of 4-foot-wide beds and 2-foot paths is the general rule. Most standard machinery is well adapted to this combination and special machinery has been designed to fit it. Paths in which sprinkler lines run must be at least 4 feet wide to allow machinery to clear the sprinklers. Beds 5 feet wide reduce the cost of sowing by hand with transverse drill seeders where these are used instead of mechanical seeders, and, like a few other odd bed and path widths (table 17), are still preferred in occasional small nurseries.

The longer the beds, the more efficiently they can be made, sown, sprayed, and lifted by machinery. The maximum length depends on the length of overhead sprinkler line that an oscillator can turn. This is usually 400 to 500 feet if the water mains cross the ends of the beds and 800 to 1,000 feet if the mains cross the middle of the beds and pairs of oscillators are used.

The surface and subsurface drainage, erodibility of the soil, and economy of sprinkler-line construction usually determine the direction of the beds. On sites with both poor subsurface and poor surface drainage, the beds should run up and down whatever slope there is. On sloping ground, where surface drainage is ample and there is some tendency toward erosion, beds should be straight and should parallel the contours as nearly as possible. (Only in extreme cases should the beds be curved to follow the contours.) On a nearly level site with good subsoil drainage and no erosion, the beds may be run in whatever direction requires the least amount of pipe for sprinkler lines. Where drainage and other conditions

permit, it may pay to run beds and sprinkler lines at right angles to the winds prevailing during germination or during the driest weeks of the summer. Such an arrangement insures optimum distribution of water from the sprinklers and minimum water loss from the beds.

Overhead sprinkler lines ordinarily are set 50 to 56 feet apart. The U. S. Forest Service places sprinkler lines 56 feet apart, with nine 4-foot beds and eight 2-foot paths between each two lines, and a 4-foot path under each line. This arrangement permits the most efficient spraying of the beds with a spray rig equipped with the standard 3-bed (15- or 16-foot) boom.

Nursery roads and road ditches and other drainageways should be laid out at the start to carry the maximum traffic and water anticipated. Roads should be at least 16 and preferably 24 feet from shoulder to shoulder. They should be graveled for all-weather service and to keep down weeds. It is usually sufficient to break nurseries into approximately 10-acre (10-million seedling) compartments by interior roads that cross one another at right angles, with each compartment containing twenty 400-foot sprinkler lines spaced 56 feet apart.

In many nurseries, terraces are essential to erosion control. They must be expertly placed and built, and well maintained, or they may do more harm than good. Sprinkler lines and straight beds should parallel terraces as closely as possible. Some effective seedling area usually is lost where beds cross terraces, although the terraces seldom need hamper machine sowing, spraying, or lifting.

So far as slope, drainageways, and terraces permit, it pays to keep beds uniform in size. Beds of exactly equal area greatly simplify fertilizing, sowing, spraying, and machine operation generally, and particularly nursery inventory and cost accounting.

SOWING

Because of the exacting requirements of southern pine seed for germination (p. 61) and of seedlings for development (p. 108), it is essential to :

- Choose the right sowing date for each species;
- determine the correct sowing rate for each seed lot;
- pulverize the soil thoroughly ;
- sow the seed on the surface;
- roll soil and seed after sowing; and
- cover the seed until germination is almost complete. Thorough watering of the beds immediately after sowing and during germination is also necessary, but is merely the beginning of a process continued till fall.

Season of Sowing

In the lower South, most sowing is in February or March ; some slash pine is sown in April. Farther north, because of the late spring, southern pine beds are sown in March or April, some even in early May.

Planting the Southern Pines

The principal exception to spring sowing is with longleaf pine, the greater part of which, since about 1939, has been sown in November and early December. January and late December are likely to be too cold even for longleaf pine. In the northerly nurseries, loblolly and shortleaf seed is also sometimes sown in the late fall, without pregermination treatment, before the ground freezes but after the temperature has become too low for germination. The overwinter contact with the moist soil takes the place of stratification, and when the soil warms in the spring the seed usually germinates promptly and uniformly and gives the seedlings the longest possible growing season.

Spring-sown longleaf beds should ordinarily be put in before those of any other species. Longleaf seed not only germinates better at low temperatures than seed of other species, but is least likely to germinate well at high temperatures (p. 62) . Furthermore, longleaf seedlings require a long growing season to attain plantable size, and late-sown longleaf is particularly subject to damping-off.

Shortleaf pine must usually be sown earlier than loblolly, because the seedlings take longer to reach plantable size. In the more southerly nurseries the growth of shortleaf seedlings practically ceases during the hottest summer weather, and early sowing is necessary to make them as large and as heat resistant as possible before this check omits.

Because of its usually prompt germination, rapid growth, and early attainment of heat resistance, slash pine may be sown the latest of the four principal southern pines. Fall sowing of slash is undesirable because it may result in premature germination of some seed during the winter, and is always likely to produce excessively large stock.

Low nursery soil fertility may require early sowing to produce seedlings of plantable size by lifting time. High soil fertility may require late sowing to prevent excessive growth; sowing of slash pine in particular is sometimes deferred until April for this reason.

Late spring sowing may decrease injury from freezing and frost heaving, the extent of bird damage and the cost of patrolling against birds, and the cost of weeding. It may reduce fusiform rust infection on slash and loblolly nursery stock, and it certainly reduces the amount of spraying necessary to control this rust. On the other hand, late sowing is likely to increase damping-off, heat and drought injury, and injury by *AS clerotium bataticola* (pp. 89 and 93).

Preparation of Ground and Seedbeds

In large nurseries much or all bed making and finishing is done with regular agricultural machinery and special bed-shaping equipment, both tractor-drawn. Handwork is limited to odd corners, to places where beds cross terraces, and to occasional final smoothing or freshening of the bed surface.

The beds must be worked when the soil is neither too dry nor too wet, especially the latter. If too dry, it is hard to break up clods or reach the proper depth. If too wet, puddling and clodding may result, with consequent injury to the crop and increase in the cost of later cultivation and weeding.

Plowing must be deep, at least 8 or 9 inches, to permit good development of seedling roots. Harrowing must be deep and thorough for the same reason, and to provide good germinating conditions for the seed. The most suitable implements depend largely on the soil, and usually can be determined by noting which types work best on similar soils nearby.

Beds must be free from any coarse organic material likely to make the surfaces uneven or to prevent good establishment of seedlings. Even light winter cover crops must be turned under 4 to 6 weeks before final bed preparation; heavy crops, considerably earlier. Only well decomposed or finely divided compost or other organic matter may be applied safely just before the beds are made up.

Light crops of annual weeds should be destroyed by plowing or harrowing a little in advance of bed making. Heavy or carryover weed crops may require repeated working during a considerable period in advance of sowing. Bermudagrass and Johnsongrass may require special harrowing before bed making. Only disk harrows should be used on nutgrass; toothed harrows spread it and make ultimate control more difficult.

Heavy soils, heavy subsoils with poor subsoil drainage, and very level sites with poor surface drainage all call for beds rather high above the nursery paths. Usual elevations are 3 or 4 inches, but in extreme cases beds are built up 6 inches or more above the paths. On soils that erode easily, or on very sandy or otherwise dry sites, beds should be kept low. Local observation and experience are the best guides to the optimum elevation, which may differ from place to place in the nursery.

Theoretically, the surface of the bed should be flat on ideal soils, slightly rounded on the less well-drained soils, and slightly troughed on droughty soils (718). Rounded beds, however, have shown little practical superiority (023), and in most southern pine nurseries bed surfaces are made flat, regardless of soil.

Curbs of low-grade lumber, nailed to stakes in the ground, were formerly used in most nurseries to keep the edges of the beds from crumbling or washing. Today almost universal practice is to add an unsown shoulder on each side of the bed; 3-inch shoulders are wide enough on most soils, but 6 inches may be needed where beds are high above the path and the soil erodes easily. Since the shoulders are on the same level as the beds, they offer no obstruction to mechanical seeders. As the season advances, the unsown shoulders gradually wash or are trampled down into the paths, until by lifting time the beds are reduced almost exactly to 4 feet and the paths widened to

full 2 feet—assuming the nursery uses 4-foot beds on 6-foot centers.

In very small nurseries, beds are shaped by hand. In large nurseries, they are shaped by attachments to farm tractors, or by special bed shapers (189, 455, 704, 718). The best of these devices space beds accurately with no guides except stakes at each end.

Hand-shaped beds are sometimes settled by allowing them to be rained on a few times and then releveling and freshening the surface just before sowing. On most soils it is quicker and equally effective to roll the beds before or after sowing, or both, with 300- to 400-pound metal or wooden rollers, preferably 4 or 5 feet in diameter. Where tractor-drawn bed shapers and mechanical seeders are used, the weight of the bed shaper partly settles the beds and the rollers in the mechanical seeder complete the process. With such equipment settling by rain or special rolling is unnecessary.

Final pulverizing of the seedbed surface can be done either by the mechanical bed shaper or with hand rakes. Surfaces that have dried in the sun or become crusted by rain are freshened by dragging or by hand raking, immediately before sowing, to permit rolling the seed into at least moderately moist soil.

Most southern pine seedbeds are machine-sown, either in drills running lengthwise of the beds, or broadcast. Drills are essential if, during the growing season, the seedlings are to be sidedressed with dry fertilizer, or cultivated. Some nurserymen feel that, on stiff soils, seedlings in drills can be lifted with less root injury than those in broadcast beds. With present-day equipment and techniques, however, especially mineral spirits weeding (p. 79), broadcast beds cost no more than drill-sown beds to sow or weed, and seem likely to replace the latter in many nurseries. Broadcast sowing reduces some diseases, particularly sand-splash damping-off of longleaf pine (p. 89), and theoretically permits better development of the seedlings than does drill sowing.

Method of Sowing

Lengthwise drills usually are sown 6 inches center to center. On a 4-foot bed, this arrangement permits eight drills between the two protective shoulders. To allow greater space for cultivation and side fertilization, some nurserymen sow only seven or six drills on a 4-foot bed, but increase the number of seedlings per foot of drill. Six drills is about the minimum without seriously overcrowding the seedlings in each drill or reducing the number of seedlings per bed.

To leave maximum clearance for cultivator and fertilizer attachments, loblolly, slash, and shortleaf seed usually are sown in as narrow a drill as possible. Longleaf seed, however, should be sown in a band 1 to 1½ inches wide, to reduce sand splash.

The commonest device for sowing drills lengthwise of the bed is the Hazard seeder (718). This consists of tractor-drawn rollers carrying eight modified grain-seeding tubes fed from a common seed hopper. The best model permits simultaneous adjustment of the streams of seed flowing through all eight tubes. Widths of drills or bands sown can be adjusted by raising or lowering the tubes or changing the shape of their outlets. For longleaf seed, the persistent wing stubs of which prevent free passage through ordinary tubes, the Williamson attachment, consisting of a wide-throated, sprocket-driven auger bit in each tube, is necessary (189, 343). Specifications, including those for an attachment which utilizes the roller of the seeder to lay cloth seedbed cover over the seed, can be obtained from the Regional Forester, U. S. Forest Service, Atlanta, Ga. There are also other means of sowing drills lengthwise (443, 718).

Seed is sown broadcast with the Hazard seeder simply by raising the outlets of the tubes well above the surface of the bed, or by incorporating a "splatterboard" beneath the openings.

Hand sowing, either in drills running crosswise of the bed, or broadcast, remains preferable to machine sowing in very small nurseries and in certain test plots in large ones. Crosswise drills, usually sown 6 inches apart, are easier to hand weed, especially in 5-foot beds, than drills running lengthwise.

The Bateman ³⁰ seeding trough, which is opened to drop seed, closed again, and moved along the bed by tall handles (fig. 23), is perhaps the most efficient device for sowing crosswise drills by hand. Two men scattering seed in their respective halves of this trough with suitable measures cut from shotgun shells or (for longleaf) baking powder tins, can drill sow about 100 linear feet of either 4-foot or 5-foot-wide bed per hour. Troughs and drills 4 feet long are used for test plots in standard 4-foot beds, but 5-foot troughs, drills, and beds are more economical where the whole nursery is hand-sown (718, 750).

Uniform hand broadcasting of seed is time-consuming and requires considerable care. Each bed and the seed for it must be systematically subdivided into equal parts, each subdivision of the seedbed sown with about three-fourths of the seed allotted to it, and the thinly sown portions touched up with the remaining one-fourth.

Density of Seedling Stand

The optimum average number of living southern pine seedlings per square foot throughout the growing season and on to lifting time usually

³⁰The late F. O. Bateman, while chief ranger of the Great Southern Lumber Co. at Bogalusa, La., defined many principles and devised many tools and techniques still applicable wherever the southern pines are planted (753).



F-224991

FIGURE 23.—Bateman seeding trough for sowing drills crosswise of the nursery bed. Pushing the handles together opens the bottom of the trough and drops the seed. Six-inch wooden guides projecting from the far side space drills correctly.

varies from about 30 to 45, depending on species and on soil fertility. Sowing in drills instead of broadcast does not reduce the optimum number unless the drills are spaced more than 8 inches apart.

Longleaf seedlings, because they are largest, should be grown at the lowest density, and slash pine at not much higher densities. Loblolly and shortleaf seedlings can be grown at higher densities than slash; the maximum is about 50 to 55 per square foot. The 70 per square foot formerly recommended for shortleaf (750) is excessive; Chapman (164) recommends a maximum of only 25 per square foot for shortleaf in Central States nurseries. At densities below 30 per square foot, slash and longleaf pine seedlings may not fully utilize the capacity of the soil; densities above 30 may decrease the size of the seedlings appreciably; increasing the soil fertility may increase the number of seedlings of a given size that can be grown per square foot (533). In general, a unit area of a given nursery soil tends to produce a constant weight of seedling tissue in the form of either many small or fewer large seedlings (682). The exact number of living seedlings per square foot that is most suitable for each nursery must be determined by local experience and tests.

The emphasis on *living* rather than on plantable seedlings per square foot is important. All living seedlings, even if unplantable because of infestation, infection, or small size, compete with and therefore affect the development of neighboring seedlings. Under favorable nursery conditions, 80 percent or more of all living seedlings are plantable. In nurseries where the number plantable consistently falls far below the number of living seedlings, the desired quota of planting stock can be met only by sowing additional beds. Sowing more seed per bed merely intensifies competition among seedlings and may make them all unplantable.

Sowing Rate

Seedling stand density depends first and foremost upon the rate at which the seed is sown. Sowing at the correct rate assures almost exactly the desired number of living seedlings per square foot at lifting time unless catastrophic injuries occur. The sowing rate can be calculated in terms either of the weight of seed to be sown per bed, or of the number of full seeds to be sown per running foot of drill.

Rates calculated by weight can be applied directly only to seed sown at about the moisture content at which the number of seeds per pound was determined; they cannot be used with seed moistened by stratification unless the seed has been stratified in small, separate lots, the dry weights of which are known (p. 55). Calculation of rates by weight requires determination of number of seed per pound, purity percent, and effective germination percent, but has the great practi-

cal advantage of not requiring cutting tests of seeds ungerminated at the end of the germination test.

Rates calculated by numbers of full seeds are applicable directly both to dry and to stratified or soaked seed, including lots from which some empty seeds have been removed with the stratifying medium. They do not involve purity percents or numbers of seeds per pound. They do, however, require determination of effective germination percents in terms of seeds with full kernels, instead of in terms of all seeds tested, and therefore necessitate cutting tests both at the end of the germination test and when adjusting the seeder.

Only part of the seeds found effectively germinable by test can be depended upon, even in the absence of epidemics and catastrophes, to produce seedlings at lifting time. Drought, heat, soil wash, weeding, nonepidemic insects, and the like inevitably cause small to moderate annual losses rather uniformly distributed throughout the beds. Any sowing rate formula must therefore include the percentage of effectively germinating seeds expected to survive until fall. In U. S. Forest Service nurseries this percentage has usually been 80 to 95, in some cases 65, and in a few instances as low as 25. In any nursery the most likely percentage must be estimated for each sowing lot, preferably in the light of past experience and records. Where previous observations are lacking, the nurseryman should assume a percentage somewhere between 90 and 70. Good overwinter storage conditions, rapid and high germination in the laboratory, favorable sowing conditions, good soil, and small likelihood of insects and diseases suggest using the higher figure. The reverse, and particularly a low germination percent (71, 586), make 70 a safer estimate.

Sowing by weight

$$\text{Weight} = \frac{(\text{Area of bed}) (\text{Seedlings desired per square foot})}{(\text{Seeds per pound}) (\text{Purity \%}) (\text{Germination \%}) (\text{Expected survival \%})}$$

In this formula :

Weight is the pounds of dry, commercially cleaned seed to be sown per bed.

Area of bed is in square feet.

Seedlings means average number of all living seedlings, plantable and unplantable, that the nurseryman wishes to have per square foot at lifting time.

Seeds per pound means average number of pure seeds determined by test or approximated from tables (p. 198).

Purity percent is that of the sowing lot, determined by test (p. 60) after final cleaning.

Germination percent is effective germination percent (p. 64), determined by test (p. 61), and based on all seeds tested.

Expected survival percent is the average percentage of the effectively germinable seeds expected to survive as seedlings at lifting time. This percentage is estimated by the nurseryman as already noted.

In applying the formula, the three percentages are expressed as decimals. As an example, how many pounds of longleaf pine seed must be sown in a 4- by 400-foot bed (1,600 square feet) to get 30 seedlings per square foot, if there are 4,200 seeds per pound, purity percent is 92, effective germination percent is 68, and 73 percent of all effectively germinable seeds are expected to survive as trees at lifting time? Carrying the calculation to three significant figures :

$$\text{Weight} = \frac{1,600 \times 30}{4,200 \times 0.92 \times 0.68 \times 0.73} = \frac{48,000}{1,920} = 25.0 \text{ pounds}$$

Similar procedure may be used to calculate the weight of seed required for a given length of drill, substituting drill length, in feet, for bed area, and number of living seedlings desired per linear foot of drill for number per square foot. In calculating how much seed to sow by hand in drills crosswise of the bed, grams are more convenient than pounds.

Sowing by number

$$\text{Full seeds to sow} = \frac{\text{Seedlings desired per linear foot of drill}}{(\text{Germination \% based on full seeds}) (\text{Expected survival \%})}$$

In this formula :

Full seeds to sow means average number of seeds with kernels, per linear foot of drill. The attainment of this number must be verified by cutting or hammer test (p. 60) while adjusting the seeder.

Seedlings means average number of all living seedlings, plantable and unplatable, that are desired per linear foot of drill at lifting time.

Germination percent based on full seeds is effective germination (p. 64), determined by test (p. 61) and based on all seeds with kernels as shown by cutting seeds remaining ungerminated at the end of the test (p. 60).

Expected survival percent is the same as in the preceding formula.

In applying the formula, the two percentages are expressed as decimals. As an example, how many seeds with kernels must be sown per running foot of drill to get 18 living seedlings per foot, at lifting time, from a lot of slash pine seed in which 90 percent of all seeds with kernels germinate effectively, in a nursery in which 80 percent of the effectively germinable seeds may be expected to survive as trees at lifting time?

$$\text{Full seeds to sow} = \frac{18}{0.90 \times 0.80} = \frac{18}{0.72} = 25 \text{ full seeds per linear foot}$$

For machine drill sowing, the seeder is adjusted during successive trial runs over a tarpaulin until all tubes combined drop the correct weight of seed within a convenient measured distance, or until each tube drops the correct number of *full* seeds per foot of individual drill. For machine broadcasting, the seeder is adjusted as though the desired average number of seedlings per square foot were to be grown in drills; then the seeding tubes are raised or a splatterboard put on to distribute the seed uniformly over the entire width of the bed.

Planting the Southern Pines

255741°—54—6

Catastrophic losses, particularly those caused by freezing, hail, flooding, mass inroads of birds and rodents, and epidemics of insects and disease, usually occur in concentrated areas instead of uniformly throughout the beds. Increasing the rate of sowing cannot reduce and, with certain diseases, may increase the losses within such concentrated areas, and results in overdense stands everywhere else. Therefore, as in the case of low percentages of plantable seedlings (p. 74), the only way to keep nursery production up to quota despite catastrophic injuries is to sow extra beds at the regularly calculated rate. With southern pines, the U. S. Forest Service increases the number of beds by 20 percent for this purpose.

Mixing Seed Before Sowing

Just before the seed is sown, it must be thoroughly mixed. If it is not, inevitable variations in germinability in different parts of the sowing lot may nullify all the care taken in sampling and testing the seed, calculating the sowing rate, and adjusting the seeder. In a number of cases, despite correct *average* rates of sowing, failure to mix seed has resulted in nearly twice the desired stand in some beds and practically no seedlings in others, with consequent injuries to stock and increases in costs.

Mixing must be done immediately before sowing. If the seed is stored very long or transported far, especially in several separate containers, between mixing and sowing, serious differences in germinability are likely to develop within and among containers and to cause corresponding variations in the density of the seedling stand.

A sowing lot that has been kept in a single container may be mixed by pouring it out on a tarpaulin or a smooth floor and turning it over several times with a shovel. Lots large enough to require more than one container are most easily mixed by spreading the seed from successive containers in thin layers one on top of another and then thoroughly mixing the layers with shovels. To avoid crushing seeds, the men doing the mixing should work without shoes.

Such mixing is an economy. The labor involved does not add measurably to the cost per thousand trees produced. The uniform stands that result from mixing not only improve the quality and uniformity of the seedlings, but also greatly reduce the cost of nursery inventories by reducing the number of samples needed for a given degree of accuracy (p. 96).

Seedbed Covers

Beds must be covered to protect seed from birds and from displacement by rain, and particularly to keep seed and soil continuously moist. The last is so even with overhead sprinklers to supply water. The covering must let water and presumably some light reach the seed. It must be

nontoxic, inexpensive, quick and easy to apply and, if need be, easy to remove. A cover which does not meet these specifications may seriously reduce or completely destroy the seedling stand.

Most nurserymen cover southern pine seedbeds with cloth or with pine needles—commonly called pine straw. Both cloth and pine straw have proved superior to grain straw, paper, sawdust, soil, and sand.

Cloth covers can be laid and removed more quickly than pine straw. During germination they give better protection against birds and flooding rains. Their chief disadvantages are high initial cost of cloth and pins, the necessity of timing their removal exactly, the tendency of certain soils to pack hard under cloth, deterioration of the cloth, and vulnerability of the seedlings to hail and to heavy rain during the first 2 or 3 weeks after the cloth is removed.

Pine straw usually requires more labor than cloth does to apply and remove, gives less protection against birds, floats away if rain floods the beds, and (*V3*) is a potential source of needle infection. Pine straw, however, requires no wire pins, prevents rain packing of the soil, and at most nurseries can be obtained in quantity at short notice. Seedlings of all southern pines except longleaf easily come up through a properly applied layer of pine straw. If too thin or too thick a layer of pine straw is applied, the thickness can be adjusted even while germination is taking place. Even longleaf seedlings are less seriously flattened and less rapidly smothered by pine straw than by cloth. Therefore removal of pine straw need not be timed as precisely as the removal of cloth; this is especially advantageous with seed that germinates slowly and irregularly. In nurseries subject to excessive heat, drought, or wind erosion, part of the straw may be left in place all summer as a mulch; in some nurseries this practice has materially improved the quality of the nursery stock.

The two favorite cloth covers are jute burlap and Osnaburg or similar rather porous cotton cloth. Burlap weighing 9 or 10 ounces per square yard is preferred; 12-ounce burlap is a little too thick and unnecessarily expensive, while 7- or 8-ounce burlap is a trifle light, especially after a season's use. The U. S. Forest Service specifies 9-ounce burlap with 11 to 13 threads per inch of warp and 10 to 12 per inch of filling. New burlap may be purchased in 100-yard rolls, in any desired width; 54-inch width is preferred for 4-foot beds. Second-hand bags may be bought already stitched together in strips, at less cost, but have the disadvantages of variations in weight and durability, seams that hinder laying and disturb the seed when the cover is removed, and, frequently, holes that expose the seed.

Although cloth covers may be laid by hand or by mechanical layers pulled behind the seeder, the best way is by a reel mounted on top of the

seeder. This device allows the cloth to pass under the roller of the seeder and to be pressed into place on top of the seed. It permits sowing even when the beds are so moist that, without the intervening cloth, soil and seed would stick to the roller.

The cloth is stretched tight and fastened down with pins stuck through the edges and into the ground—most efficiently by two men riding a low trailer drawn behind the burlap layer or seeder. The pins are usually 15-inch lengths of No. 8 uninsulated telephone or slightly heavier galvanized wire, bent to a ring at one end. Placed at 3-foot intervals to keep the wind from flapping the cloth and injuring the seedlings, such pins for a 4- by 400-foot bed require about 350 feet of wire. Pins for an acre of 4-foot beds with 2-foot paths require about 6,000 feet of wire.

Cloth covers must be removed before an appreciable percentage of the first seedlings have been smothered or have worked their way through the fabric, but not until most of the seed has germinated. (These requirements place a premium on uniformly rapid germination of the seed, and are one of the principal reasons for pregermination treatment.) A rough practical rule is to take off cloth covers when seedbed germination equals two-thirds to three-fourths of laboratory germination—usually from 10 to 35 days after sowing, but in extreme cases as few as 6 or as many as 60 days. Great care in as well as correct timing of removal is necessary to avoid destruction of seedlings just taking root (p. 80).

For storage after use, cloth must be cleaned by washing (laying it on the grass in the rain is common practice) or beating, and must be thoroughly dried. Failure to clean and store untreated cloth covers properly may necessitate buying a complete new supply each year. Recently developed treatments with copper naphthenate alone (*49*) or copper naphthenate and chrome (*Teen*) promise to prolong the life of burlap bed covers greatly. Details of the latter treatment, including precautions to avoid injury to seed, may be obtained from the Regional Forester, U. S. Forest Service, Atlanta, Ga. Treatment at the nursery costs about 5 cents a linear yard.

Pine straw is scattered evenly over the beds by hand or with forks, or with a manure spreader modified to prevent sidewise scattering. The correct depth is $\frac{1}{2}$ to 1 inch before settling and less than $\frac{1}{2}$ inch after settling—just enough to conceal the seed from sight. The pine straw required for a 4- by 400-foot bed totals between $2\frac{1}{9}$ and 5 cubic yards. An acre of 4-foot beds with 2-foot paths requires 45 to 90 cubic yards of straw. Loblolly pine straw is most satisfactory; slash is next. Shortleaf pine straw is rather fine and longleaf somewhat coarse for best results. The fewer twigs and cones the pine straw contains, the easier it is to spread. Storing the straw in piles for a year before use rots it somewhat and facilitates uniform distribution with a manure spreader.

WATERING, WEEDING, AND RELATED CARE

Watering

Southern pine seedbeds generally need about an inch of water a week—perhaps slightly more on light and slightly less on heavy soils—from the time they are sown until late August or early September. In most southern pine nurseries, deficits in rainfall are made up from demountable overhead sprinkler lines supplied from permanent underground mains and oscillated automatically by water motors. Such sprinkling systems usually require 8 or 9 hours to apply the equivalent of 1 inch of rain. Semipermanent rotary sprinklers have been used in a few nurseries of intermediate size, and some small nurseries have been watered with various portable sprinklers (771). Watering southern pine seedbeds by surface or subsurface irrigation has proved impracticable.

More than any other nursery operation, watering depends on the personal judgment of individual nurserymen. As a general rule, timing of watering is more important than the exact amount of water applied, particularly until the roots have reached a depth of 4 or 5 inches and enough primary needles have developed to shade the soil considerably. Excessive watering should always be avoided, however. It not only increases costs, but may leach nutrients out of the soil. An inch of water at one time is the usual maximum. Watering should always be stopped before it results in appreciable sand splash, runoff, or sheet erosion, and it should be reduced or withheld if damping-off occurs (p. 89).

The seedbeds must be thoroughly soaked right after sowing and kept continuously moist as long as the bed covers are in place. Drying of the surface soil under the covers for even a day or two may cause heavy losses of germinating seed, particularly if it has been stratified. Beds must be kept equally moist for the first 2 or 3 weeks after the removal of cloth covers.

Need for watering can best be judged from the portions of the seedbed area which dry out most rapidly. Until roots reach a depth of 5 inches and tops shade the ground well, the beds should be watered whenever the soil in those portions dries visibly to a depth approaching 1 inch.

Surface-soil temperatures high enough to be injurious may occur during the first weeks following the removal of the bed covers, when southern pine seedlings seem most vulnerable to heat (p. 84). Watering during the heat of the day may reduce surface-soil temperatures by as much as 20° F. (10), and may prevent extensive losses if begun promptly at the first sign of heat injury. Wide observations over many years have shown an instance of injury to coniferous nursery stock from watering in full sunlight (223, 224, 302, 750).

Application of about one-half inch of water at a time will stop wind erosion of surface soil between the removal of bedcovers and the beginning of rapid top growth in June or July.

During dry periods, seedbeds must always be watered thoroughly before being weeded by hand or with mineral spirits.

From early June through perhaps the first half of August the increasing demand of the seedlings for water may usually be met by watering whenever rain for the past week has totaled less than an inch and there is no promise of rain, or when the top 2 inches of soil in the more rough parts of the nursery become visibly dry. In some nurseries the wilting of young, succulent broad-leaved weeds gives warning that water is needed. Deeper seedling root systems make exact timing of watering less important during this period than in the first part of the growing season. A study of 225,000 longleaf pine seedlings showed no significant differences in the numbers and sizes of longleaf seedlings produced under equal amounts of water applied in light and frequent and in heavy and infrequent sprinklings. Theoretically, however, the latter would waste less water by evaporation and might (480, 640, 647) produce planting stock more resistant to drought. Shortleaf seedlings receiving equal total amounts of water survived significantly better when the water was applied at 4-day intervals instead of in correspondingly smaller dosages each day (161).

Extra watering during the hottest hours of the day may sometimes be necessary during the summer months to help control red spider or *Selerotitan, bataticola* (pp. 87 and 93).

Most nurserymen reduce or stop watering from mid-August or early September onward, to "harden off" the stock. This appears sound practice, not only to save costs, but also to improve the physiological quality (pp. 108 and 109) of the seedlings (366, 480, 640, 647), and possibly also to improve the development of their roots (408). Water must not, however, be withheld to the point of preventing normal growth or of causing mortality from late-season drought. In very dry years perhaps one-half inch of water per week may have to be applied until mid-September or early October. The appearance of the seedlings and the moisture content of the soil are the principal guides. Undersized seedlings on infertile soil should not be watered copiously in the fall to force their growth; the correct treatment for such backward stock is late-season fertilization (p. 114).

Weeds

Weeds compete with seedlings for moisture, mineral nutrients, space, and light; if allowed to grow unchecked, they stunt or even kill large percentages of the stock. In the less fertile soils they may seriously deplete mineral nutrient reserves, especially phosphorus. They attract or support

cutworms and red spiders, and possibly nematodes and other pests. If left in the beds until winter, they slow down lifting. Good nursery stock cannot be produced at reasonable cost without controlling weeds, yet control may be expensive, too. Hand or machine weeding usually costs from \$0.75 to \$5 or even \$7 per thousand seedlings produced, injures seedling tops and roots, and may increase damping-off. Chemical weeding may cost only 5 to 10 cents per thousand seedlings, but requires expensive equipment and if done incorrectly may kill seedlings instead of weeds (140, 191, 005, 222, 223, 373, 420, 763).

Spring and summer weeds are the main source of trouble. Winter weeds which start up in fall-sown or early spring-sown seedbeds, or before late spring-sown beds are prepared, usually are not a serious problem. They grow slowly and are often small. Many of them die when warm weather comes. Often they can be destroyed by slightly modifying cultural practices, such as choice of winter cover crops, and particularly the date of sowing pine seed.

In most southern nurseries, grasses, or grasses and sedges, predominate among spring and summer weeds, but broadleaved weeds usually are important also. The most troublesome weeds of either class are the rank growers ; the abundant, aggressive seeders; those with seeds capable of living one to several years in the ground ; those seeding at an early age ; those that propagate themselves by stolons, rhizomes, and bulbs (like Bermudagrass (*Cynodon dactylon* (L.) Pers.), Johnsongrass (*Sorghum halepense* (L.) Pers.), and nutgrass flatsedge (*Cyperus rotundas* L.) , known locally as nutgrass or cocogress) ; and the hardy perennials. Of more than a hundred species of summer weeds in any one nursery, eight or nine may be particularly obnoxious because of their persistence or abundance (457).

Nutgrass is spread by toothed harrows or similar equipment capable of dragging its chains of bulbs about, and is perhaps the most difficult of all southern weeds to eradicate (363, 486, 668, 669). Small colonies of nutgrass appearing in nurseries hitherto free from this species should be eradicated, regardless of cost, before they spread.

Indirect Weed Control

The difficulty and cost of weeding may usually be reduced indirectly by : (1) Alternating heavy cover crops, such as velvet beans, with pine seedling crops, to smother the weeds and discourage their seeding; (2) killing weeds while small, by repeated cultivation when the beds are in neither cover crops nor pines ; (3) mowing or eradicating weeds around the nursery to keep seed from blowing or washing in ; (4) avoiding compost material (p. 115), manure (56, 139), seedbed covering, or other substances containing many weed seeds ; and (5) scheduling sowing so that as little weeding as

possible need be done while the seedlings are small and easily injured.

Skimping the first two weedings of the season greatly increases the number and cost of later weedings ; delaying the first two is even worse. Budgeting money and labor for prompt and thorough early weeding is essential, whether direct control is by hand weeding or other means.

Hand and Mechanical Weeding

Before 1947, practically all southern pine nursery stock was weeded entirely by hand, or by hand in combination with hoeing or machine cultivation. Some hand weeding is a necessary supplement to chemical weeding.

For greatest effectiveness, hand weeding must be done before the weeds are large enough to compete seriously with the pine seedlings or to injure the seedlings while being removed, and before the weeds have produced seeds, bulbs, stolons, or rhizomes. The worst mistake in most nurseries has been to defer hand weeding too long.

Dry beds should always be watered a few hours before weeding. Weeding on dry ground is slow, and results in breaking off many weeds instead of pulling them up.

Hand-weeded southern pine seedbeds usually require 4 to 7 complete weedings a year. Weeding must be done most promptly and frequently on the most fertile soils. In extreme cases individual beds have been weeded 12 to 24 times in one season. It often pays to keep a small crew patrolling the nursery late in the season to pull any weeds that may have escaped earlier hand or chemical weedings and grown above the tops of the seedlings (191, 457).

Depending on seedling age and row spacing, 30 to 50 percent of the surface of drill-sown beds can be freed from weeds, at the time weeding is most needed, by means of narrow-bladed hoes or mechanical cultivators. Many millions of southern pine seedlings have been weeded mechanically with more or less satisfactory results (189, 443, 718, 731). Mechanical cultivators have reduced total weeding costs by as much as 40 percent (731), even though they have had to be supplemented by hand weeding close to and within the rows. Cultivation must be very shallow to avoid injuring seedling roots. The chief drawbacks of mechanical cultivation have been destruction of seedlings at or outside the margins of the rows, mechanical injury to and possible *Sclerotium* infection of surviving seedlings, and lodging of soil against or on seedlings, especially longleaf, with attendant damping-off. These difficulties have been reduced greatly by using improved cultivator shoes that slice just under the soil surface instead of raking it, and that have sideguards to keep loose dirt away from the seedlings. Latest cultivator designs may be obtained from the Regional Forester, U. S. Forest Service, Atlanta, Ga.

Chemical Weeding

In 1946 and 1947, nursery specialists in the South and elsewhere adapted to coniferous seedbeds a method of weeding carrots and parsnips by spraying with undiluted mineral spirits³¹ (191, 241, 393, 600, 700). Properly applied, the mineral spirits cause little or no injury to southern pine seedlings, and quickly kill a great majority of common weed species, including most of those particularly abundant or hard to eradicate in southern nurseries. By the end of 1949, practically all of the 200 million pine seedlings being produced in the South were being weeded with mineral spirits. The new method reduced weeding costs to 5 or at most 10 cents per thousand seedlings produced. There has been no indication that its use lowers plantation survival or harms the nursery soil.

Mineral spirits (common dry cleaning fluid, "Stoddard Solvent," "Sovasol—No. 5," "Varsol," "Stanisol," "Sohio Weed Killer," and the like) derived from naphthenic petroleum contain about 15 percent of aromatic components, which are thought to be what kill the weeds. Under circumstances not yet fully understood, mineral spirits may injure or even kill southern pine seedlings. These circumstances may occur in any nursery through some combination of atmospheric and soil conditions and stage of seedling development. Unless any proposed date, dosage, and time of day of mineral-spirits spraying falls well within previously demonstrated safe limits, a test on small plots should be made before use on seedbeds. The quantity, fineness, and uniformity of spray on such plots must, however, closely match those for large-scale application, or the test may be dangerously misleading.

Weeds which, because of size or natural resistance, are not killed by mineral spirits must be eradicated by hand or other means before they go to seed. The resistant weeds, if allowed to seed, will build up a new weed population which cannot be controlled with mineral spirits. Minimum procedure is to hand pull all resistant weeds a week or more before final spraying; pulling disturbs the soil and causes seeds of other weeds to germinate in time to be caught by the last spray.

Heavy applications have caused some injury to secondary needles in late August and early September. The seedbeds should be freed of weeds and spraying terminated before this time.

Methods of using mineral spirits, as a result of 1947 to 1950 tests in its own and cooperating State nurseries, were developed by the U. S. Forest

Service. The following suggestions are drawn from the Service's specifications, but because the method is so new in the South, the current revision should be obtained from the Regional Forester, U. S. Forest Service, Atlanta, Ga.

1. Equip sprayer with low-pressure manifolds, installed to permit low-capacity spraying for weed control and high capacity with insecticides or fungicides, and with teejet nozzles which throw a fan-shaped spray. Nozzles must have 100-mesh screens, and be spaced 20 inches apart on a boom 17 to 19 inches above the bed.

2. Keep the working pressure below 60 pounds per square inch to avoid "fogging." Fogging causes wind drift, which results in irregular application and sometimes severely injures the pines.

3. Regulate rate to avoid injuring the pines. Start spraying 10 to 14 days after removal of seedbed covers or after seedlings emerging through mulch have acquired a healthy green color, and apply 10 to 12 gallons per acre 2 to 4 times per week.³² Later, applications of 25 gallons per acre about once a week are satisfactory. Invariably, heavy mortality has followed application of 40 to 80 gallons per acre on very young seedlings.

4. Water the seedbeds several hours before spraying, except right after a rain. Water more heavily the older and larger the seedlings. Do not, however, spray seedlings with secondary needles while the foliage is still wet, as injury results. Do not water beds immediately after spraying, as rain or heavy watering soon after spraying reduces the effect on weeds.

5. During the first few sprays of the growing season, avoid spraying at excessively high temperatures and at temperatures below 60° to 75° F.; these increase injury to the pines, and decrease weed killing, respectively. Spraying at high temperatures in July and August has, in general, not injured the seedlings and has increased the rapidity and completeness of weed kill.

Allyl alcohol, applied to the soil at the rate of 360 pounds per acre several days before sowing, has increased emergence and survival of slash and longleaf pines, and has given excellent early-season control of weeds, including several species resistant to mineral spirits. The same substance has proved effective in weeding red pine in the Lake States. Allyl alcohol is dangerous to handle, but if means can be devised for applying it safely and it is found to have no harmful effects on the soil, it may prove a valuable supplement to weeding with mineral spirits. (32, 426.)

Shading

Shading of seedbeds in the spring or summer was thoroughly tried in the early years of southern pine nursery practice. It was soon found both

³¹ Attempts to weed southern pine seedbeds with chemicals began in 1924, but until 1946 were not successful. Chemicals found partly or wholly ineffective in southern pine nurseries, or for one reason or another inapplicable under southern nursery conditions, include chloropicrin, Dowicide-H, ferric chloride, fuel oils, sulfuric acid, tetramethyl thiuramdisulfide, zinc chloride, zinc sulfate, and 2,4-D (2,4-dichlorophenoxyacetic acid) and some of its compounds (50, 191, 191, 354, 457, 519, 598, 700, 750, 770).

³² A table of gallons of liquid applied per acre by two different teejets at specified pressures and rates of travel may be found in Catalog 55, Spraying Systems Co., 3201 Randolph St., Chicago, Ill.

expensive and unnecessary. It did not consistently increase germination. It frequently increased damping-off, and tended to make seedlings too tall and slender, to delay formation of secondary needles, to affect root development unfavorably, and to reduce plantation survival (345, 750). In one study, shaded seedlings survived only 19 percent the first year in the field and produced only 261 cubic feet of wood per acre in 10 years, as against 40 percent and 561 cubic feet for unshaded check seedlings. Since 1935 practically no southern pine nursery seedlings have been grown under shade.

Shades on small portions of the beds are, however, useful in diagnosing injuries suspected of being caused by drought and heat, red spider, *Sclerotium bataticola*, and possibly erosion caused by rain or sprinkling. The shades can be made of light cotton fabric or of lath, supported about 20 inches above the bed. If the changes they produce in temperature or moisture control the injury, similar changes can usually be produced over large areas by increased watering, or by mulching.

Seedbed Cultivation

Except for weed control, surface cultivation of southern pine seedbeds is used only on a few peculiar nursery soils and cannot be generally recommended. The alleged benefits of such cultivation—breaking up surface crust, reducing damping-off, increasing water absorption, reducing water loss, and stimulating seedling growth—have not been generally or strikingly demonstrated in southern pine nurseries.

Cultivation has several serious disadvantages. It requires drill-sowing; for application beyond the early months of the growing season it requires fewer than 8 drills to the 4-foot bed. Hand cultivation is extremely expensive; machine cultivation requires special equipment in addition to the cost of machine operation. Hand and especially machine cultivation increase sand splash of longleaf pine (222), and cause mechanical injury (p. 94) to all species. In one study, machine cultivation, in addition to increasing the cost per bed, reduced the number of plantable seedlings by 16 percent.

NORMAL DEVELOPMENT AND GROWTH

To correct abnormalities of southern pine nursery stock, or prevent their recurrence, the nurseryman must recognize them promptly. To do this, he must first know the appearance and size of normal stock at each stage of its development.

Most of the following summary of normal development is from a study started at the Stuart Forest Nursery, near Alexandria, La., in 1934 and continued through 1936 (344). This nursery is fairly representative of many in the lower South, although the soil is somewhat heavier than aver-

age. Mean monthly air temperatures during 1936 ranged from 47° to 83° F. For the period March through December 1936, mean monthly surface soil temperatures ranged from 55° to 89° and mean relative humidity was above 60 percent. Despite local variations in detail, the general results of the study have been confirmed by observations throughout the South.

In the study, each of the four principal southern pines was drill-sown in the spring in 1, 2, or all 3 years. The seed was covered with burlap during germination. The seedlings were hand weeded and were sprayed with fungicides as required. Soil moisture content was maintained above 10 percent. To insure uniform growing conditions, the beds were sown rather heavily and the seedlings were thinned to uniform optimum density in May; other than this, the seedlings were given no special treatment. The stock studied in each year was comparable in size and appearance to that from the rest of the nursery. Longleaf, slash, and shortleaf pine seedlings studied in 1936 survived 97 to 99 percent when planted in the field.

The course of germination recorded in the study may be accepted as normal, even though the seed exhibited only the low to moderate germination percentages common in the middle thirties. Nursery germination approximated laboratory germination, damping-off was negligible, and the seedlings showed none of the later poor development reported for seed lots known to be of low vitality (89, 596). The radicles emerged from the seed coats 12 to 20 days after sowing (p. 76). Radicle tips of undisturbed seeds turned down and entered the soil within a day or two after emerging from the seed coats. There followed—at rates depending mostly on species and temperature—lifting of the seed coats off the ground by the cotyledons (longleaf) or cotyledons and stem (other three species), and, gradually, shedding of the seed coats and spreading apart of the cotyledons into a rosette, revealing the rudimentary primary needles, and the other stages of normal growth until the winter buds appeared on the stem and the growing points multiplied on the roots (fig. 24).

Developments in 1934, 1935, and 1936 were closely similar except for variations in depth of root penetration. Root depth varied considerably among species (fig. 24), and within species it varied more from year to year than did most seedling characteristics. Other studies of southern and other pines have shown that soil texture and soil moisture greatly influence depth of root penetration (51, 341, 408).

Even allowing for the variability in root penetration, the data show that spring-sown southern pine nursery seedlings require from 1½ to 2½ months to germinate and to develop the deep tap-roots and numerous lateral roots necessary to withstand much drying of the seedbed soil. Comparable data for fall-sown longleaf nursery seedlings are not available, but natural longleaf seedlings

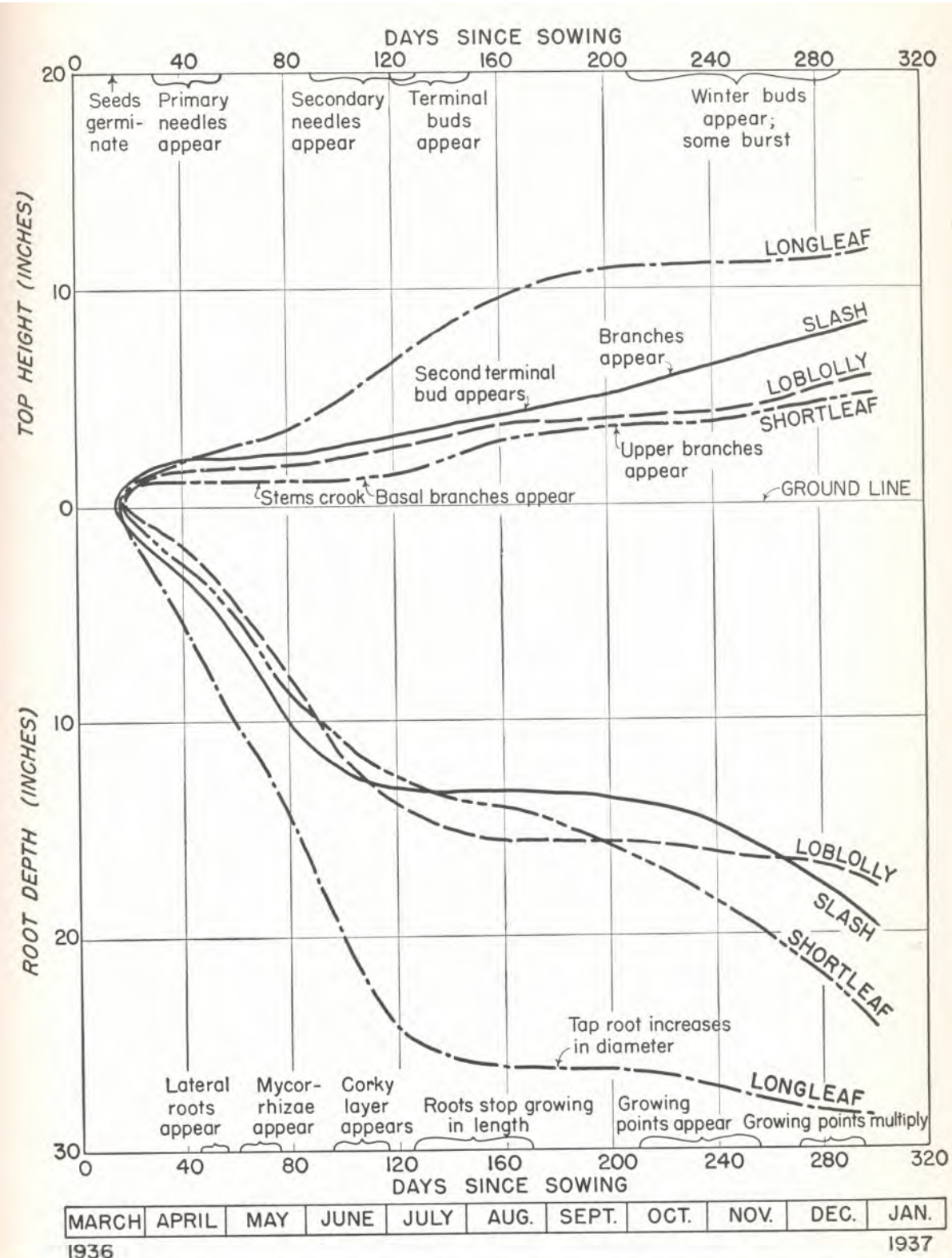

FIGURE 24.—Normal development of seedlings of the four principal southern pines under practices standard at the Smart Nursery, near Alexandria, La., in 1936. (Adapted from Huberman (344).)

from seed germinating in November and December had 4- to 7-inch taproots and abundant short laterals the following February, and 10-inch or longer taproots and about 60 laterals apiece by April 20 (525).

Two important findings in the study were that low tree percent was attributable primarily to loss of viability of the seed before sowing, and that among causes of loss during and after germination, failure to take root in the soil was the most serious and in some instances killed 20 percent of the seedlings. The first fact emphasizes the importance of correct overwinter storage of seed. The second shows the importance of careful watering during germination and of careful removal of bed covers. Losses following successful rooting were small. No losses could be traced to heat injury (p. 84), even though surface soil temperatures frequently exceeded 120° and sometimes exceeded 130° F.

The development of secondary needles by longleaf pine seedlings marks the beginning of susceptibility to brown spot needle blight (p. 93) and consequent need for spraying. In 1936 the spring-sown longleaf in the Stuart Nursery produced secondary needles early in June, about 95 days after sowing; in 1935 and 1934, not until late June and early July, respectively. The date of secondary-needle production by fall-sown longleaf is much earlier than that for spring-sown, and necessitates correspondingly earlier spraying to prevent infection. Natural longleaf seedlings from seed germinating in November and December have started to produce secondary needles by April 20 (525).

Three facts shown by the study are thought to have a direct bearing on the evaluation of southern pine seedling grades (pp. 102-110) and on the initial survival of planted southern pines. Incidentally, these facts make it questionable whether the term "dormant," or even "top dormant" may correctly be applied to southern pine seedlings during the ordinary winter lifting and planting period.

First, the study confirmed previous observations that root growth of southern pine nursery seedlings increases about the time top growth decreases in the fall, and remains very active throughout the lifting and planting season. This has been found true as far north as Maryland.

Second, in addition to forming and then promptly elongating and opening a distinct set of buds during the summer (two sets of such buds in slash pine), each species opened an appreciable percentage of its winter buds just before or during the usual lifting season. This common phenomenon and its possible effect on initial survival have been the subjects of much speculation. In the light of the present study it can hardly be considered abnormal, and, as will be shown later (pp. 126-127), such breaking of winter buds does not necessarily reduce survival.

Third, the dry weights of the seedlings, and particularly of their tops, increased greatly between the first week of December and the first week of January. During this period few winter buds opened, and there were negligible average increases in stem lengths, stem diameters, numbers of needles, or needle lengths. Yet the dry weights of tops increased 23 to 82 percent (table 18), depending upon species. In the climate of the Stuart Nursery, much of this increase in dry weight of the tops seems clearly attributable to the elaboration of food during the period in question and to the storage, in the stems, foliage, and buds, of the food not needed for the active root growth then taking place. Such accumulation of food reserves presumably has an important favorable effect on survival after planting (p. 109).

At lifting time, all years combined, the longleaf seedlings studied in the Stuart Nursery averaged nearly 12 inches high, measured to the tips of the longest needles, and the slash, loblolly, and shortleaf seedlings averaged nearly 10, 6, and 5 inches, respectively, measured to the tops of the stems. These are perhaps below the averages for southern pine nurseries in general. Some nurseries regularly ship loblolly stock 10 to 12 inches high and slash stock 14 to 18 inches high. On the other hand, longleaf seedlings only 6 inches high, slash and loblolly only 5 inches high, and shortleaf only 4 inches high are generally accepted for planting and frequently make excellent survival and growth (pp. 105-108) (161). Final heights attained by loblolly seedlings in one study of soil texture and fertility ranged only from 2.3 to 3.8 inches (51). Absolute heights, diameters, or weights of southern pine seedlings are at best rather inexact indicators of normality or abnormality, because seedlings that would be abnormally small for one nursery might be of normal size for another with a different soil or a shorter growing season. Conspicuous changes in size from year to year in a nursery may, however, be valuable clues both to the pattern of normal development and to incipient soil deterioration.

Mycorrhizae appeared fairly early in the development of the seedlings in the Stuart Nursery study (fig. 24), and were abundant on all lots of the stock at lifting time. Mycorrhizae may be described roughly as mantles or sheaths of fungus tissue covering very short seedling roots and in part entering into or between the root cells. They also cause the tips of the rootlets to appear to the naked eye as tiny, usually light-colored, forked or fingerlike growths. Several forms occur, the commonest of which are probably important in water absorption and mineral nutrition, and possibly essential to growth or even to survival of several pines, including loblolly, slash, and shortleaf (60, 273, 307, 309, 400, 500, 584, 808, 809). Ordinarily they are abundant on good stock and present to some extent even on poor seedlings, in almost all southern pine nurseries. Scarceness or absence of

mycorrhizae, or the appearance of unusual forms on obviously unhealthy stock, should be considered a suspicious abnormality.

Root hairs were not observed on the seedlings in the Stuart Nursery study. They do occur on southern pine seedlings, and have been reported

TABLE 18.—Mean dry weights of tops and roots of Stuart Nursery seedlings at specified intervals during the 1936-37 season, after Huberman (344)

Species and date	Days after sowing	Top weight		Root weight	
		Mean	Increase ¹	Mean	Increase ¹
	Number	Grams	Per-cent	Grams	Per-cent
Loblolly pine:					
Apr. 1	20	0.01		0.01	
Apr. 22	42	.01	0	.01	0
May 13	63	.05	400	.03	200
June 3	84	.09	80	.05	67
June 24	105	.21	133	.10	100
July 15	126	.26	24	.11	10
Aug. 12	154	.72	177	.22	100
Sept. 9	182	1.06	47	.23	5
Oct. 7	210	1.70	60	.42	83
Nov. 4	238	1.37	-19	.43	2
Dec. 2	266	1.68	23	.75	74
Jan. 6	301	2.07	23	.90	20
Longleaf pine:					
Apr. 1	20	.03		.01	
Apr. 22	42	.07	133	.03	200
May 13	63	.17	143	.08	167
June 3	84	.41	141	.20	150
June 24	105	.73	78	.32	60
July 15	126	1.03	41	.36	12
Aug. 12	154	1.41	37	.56	56
Sept. 9	182	1.76	25	.75	34
Oct. 7	210	2.23	27	.86	15
Nov. 4	238	2.36	6	.96	12
Dec. 2	266	2.77	17	1.26	31
Jan. 6	301	5.03	82	3.33	164
Slash pine:					
Apr. 1	20	.01		.01	
Apr. 22	42	.03	200	.01	0
May 13	63	.08	167	.05	400
June 3	84	.15	88	.08	60
June 24	105	.25	67	.09	13
July 15	126	.47	88	.14	56
Aug. 12	154	.85	81	.23	64
Sept. 9	182	1.06	25	.30	30
Oct. 7	210	2.01	90	.44	47
Nov. 4	238	1.86	-7	.54	23
Dec. 2	266	2.19	18	.62	15
Jan. 6	301	3.41	56	1.11	79
Shortleaf pine:					
Apr. 1	20	.01		.01	
Apr. 22	42	.01	0	.01	0
May 13	63	.04	300	.03	200
June 3	84	.05	25	.05	67
June 24	105	.12	140	.06	20
July 15	126	.22	83	.10	67
Aug. 12	154	.49	123	.15	50
Sept. 9	182	.88	80	.24	60
Oct. 7	210	1.14	30	.36	50
Nov. 4	238	1.04	-9	.58	61
Dec. 2	266	1.36	31	.86	48
Jan. 6	301	2.24	65	1.65	92

¹ Since previous weighing.

on loblolly and shortleaf pines 10 and 11 years old. Abundant root hairs (though far less abundant than on hardwood seedlings of the same age) have been observed on loblolly pine seedlings 7 weeks old. They occur principally on the youngest portions of long roots. They are destroyed, however, by the formation of mycorrhizae, which also prevents the formation of new root hairs. Although their presence has erroneously been assumed, root hairs seem not to have been observed on normal southern pine seedlings at lifting time. If they do occur at this stage of seedling development, they probably are far less important absorbing organs than are mycorrhizae. (384, 588.)

In many if not in all nurseries, a crook at ground level is a normal characteristic of shortleaf pine seedlings. In some nurseries this appears on the larger and more vigorous seedlings but not on overcrowded, weak, or otherwise backward stock. In the Stuart Nursery study, in 1936, such crooks developed on shortleaf seedlings about the middle of May (fig. 24).

Although cold seldom affects the color of longleaf seedlings, slash pine seedlings are likely to turn bronze-colored or bronzy-purple, shortleaf bluish or purplish, and loblolly a duller green or somewhat blue, with the first hard frost. These color changes are normal, do not affect survival, and should not be confused with color changes caused by nutrient deficiencies or other injuries (p. 95).

NURSERY INJURIES AND THEIR CONTROL³³

Control of nursery injuries depends on anticipation or early discovery and identification, and on prior or immediate application of the specific treatment for each. Early discovery of injuries demands daily inspection of the nursery. Prompt treatment often requires that a spray rig and all necessary chemicals and supplies be on hand before the trouble starts. The following pages describe, within each of several classes, the major injuries, and a few minor ones sometimes confused with them, as nearly as possible in the order of their appearance after sowing. Recommended insecticides, fungicides, and the like, and details of their application, are described on pages 202 to 214.

Climatic Injuries

Their occurrence during or shortly after extreme weather conditions makes most climatic injuries easy to recognize. The exceptions are drought

³³ Upwards of a hundred reports, memoranda, letters, and personal communications, in addition to the printed and processed references cited, have been drawn upon for the information in this section. Acknowledgment is hereby made to personnel of the U. S. Bureau of Entomology and Plant Quarantine, the U. S. Bureau of Plant Industry, Soils, and Agricultural Engineering, the U. S. Forest Service, and various State forest services for such unpublished information.

injury and heat injury, which sometimes are difficult to tell apart.

Freezing may kill part or all of the tissues of newly germinated seedlings, and the frozen tissues dry up or decay. Freezing seldom involves all of the crop in large nurseries, but may be extremely destructive in particular beds. Fall-sown long-leaf pine is most likely to freeze, particularly just after the removal of cloth seedbed covers. Pine-straw covers may reduce injury, but the principal safeguard is to avoid sowing during periods which local weather records show to be hazardous. Because freezing normally occurs early, ruined beds can usually be resown.

Frost heaving results from repeated freezing and thawing of the soil. It works young seedlings upward until part or all of the root is exposed, and they die. Frost heaving is most frequent in the more northerly nurseries, and on heavy, poorly drained, or temporarily overwet soil. Leaving pine-straw bedcovers in place after germination may reduce or prevent frost heaving, but the best safeguard lies in the judicious timing of sowing. Severe injury usually takes place early enough in the year to permit resowing the beds.

Hail destroys seedlings, usually while they are in the cotyledon or early primary needle stage, or injures them enough to reduce later survival or growth (223). Hail is likely to affect a larger percentage of the nursery than freezing or frost heaving, though at less frequent intervals. It may seriously upset production in an individual nursery, since it may occur too late in the spring to permit resowing. It can be guarded against only by sowing extra beds.

Rain may kill or stunt seedlings by beating them down, washing them out of the beds, inundating them, or covering them with soil. It does additional damage indirectly by removing top soil, increasing incidence of various diseases, washing off fungicides or insecticides, leaching nutrients out of the soil, causing excessive late-season growth, deranging sowing and lifting schedules, and stimulating weeds. Injuries are most serious on the more steeply sloping sites and erodible soils, and in poorly drained places, and are heaviest in the period between removal of covers and the formation of secondary needles; the loss of a million seedlings in a single heavy rain in one nursery has been recorded (456). Good soil management (including terracing where needed) and retention of pine-straw bedcovers after germination reduce losses. Some losses are unavoidable, however, and are one of the principal reasons for sowing 20 percent of extra beds.

Drought and *heat* during germination and the cotyledon stage often cause heavy mortality. Stunting, fertilizer injury, and outbreaks of *Sclerotium bataticola*, red spider, and chlorosis may be anticipated from drought and heat in the

summer or fall, and late-season drought accentuates damage by white grubs. Drought and heat are most serious on the lightest soils. Well-authenticated cases of direct injury to southern pine seedlings by heat alone are rare (223), even though nursery surface soil temperatures in June, July, and August very often exceed 120° F. and often exceed 130° F. (344, 345, 750). Southern pine seedlings evidently are naturally well adapted, in the manner characteristic of some western species (605), to survive heat.

The stems of young seedlings that are injured by heat shrivel and become pale; at first there is a definite boundary between the shriveled and healthy parts; affected seedlings usually are scattered rather than in definite groups; and the healthy parts are relatively slow to decay. Drought affects scattered young seedlings also (and, less frequently, patches of seedlings as well, but without conspicuous evidence of damping-off around the patches); seedlings wilt the entire length of the stem, which sometimes curves before shriveling or rotting at any point; digging may show the soil dry to a level below the seedling roots. On older seedlings heat lesions may appear on one side only (usually the south) or all around the stem; fresh heat lesions are characteristically pale and sharply defined, and are at or just above the soil surface and do not extend below it; older lesions on the larger seedlings may be surmounted by slight swellings. In late-season drought, needles, shoots, or whole plants die in definite streaks or patches sometimes 3 to 10 inches wide. Browning from drought sometimes is inconspicuous until several days after the dry weather which causes it, and death of the roots coincides with that of the tops, or even precedes it (223, 302).

Thorough watering is the best safeguard against drought. Light watering during the hottest part of the day controls heat injury, and involves no danger to the seedlings (p. 77), but early sowing at adequate rates should make watering for this purpose unnecessary. Retaining part of a pine-straw cover after germination reduces both drought and heat hazard to young seedlings. Close weeding reduces drought hazard considerably, as do early sowing, increasing soil organic matter, improving soil tilth, and, in some instances, reducing the elevation of seedbeds above the paths.

Wind accentuates the danger of drought, and in some nurseries removes much surface soil. Wind-blown sand killed 16 million tender young slash pine seedlings in one southern pine nursery in 1947. Watering during dry, windy periods, early sowing with stratified seed to insure early establishment of full stands, retention of pine straw on the beds after germination, and increasing the organic-matter content of the soil all help to reduce wind damage. In nurseries subject to constant strong winds during the spring or summer, planting windbreaks has reduced the injury.

Birds, Mammals, and Crustaceans

Birds are one of the greatest early hazards in practically all southern pine nurseries. Mourning doves, meadowlarks, bobolinks (ricebirds or reed-birds), various blackbirds, domestic pigeons, cardinals, bobwhite quail, and various sparrows are the most troublesome species. They not only eat the seed but kill or severely injure newly germinated seedlings by clipping off cotyledons with seed coats still adhering. They may get large quantities of seed through light or ragged cloth seedbed covers or light pine-straw covers or may even tunnel under a heavy pine-straw cover. Damage rises to a peak when seedbed covers are removed and often continues until the seed coats have dropped from the cotyledons.

The most effective controls have proved to be 9- or 10-ounce burlap or close-woven Osnaburg seedbed covers, automatic exploders (203) utilizing calcium carbide to make a loud noise every few minutes, and patrols of men or boys either afoot or on bicycles. Patrols must be on duty throughout the daylight hours from the first removal of covers until the seedlings have passed out of danger. Several species of birds, especially doves, are most destructive at dawn and dusk. Patrolmen use blank cartridges, air rifles, slingshots, or watchmen's rattles to scare the birds away. Killing most species is illegal, and is undesirable because they consume cutworms and other insects. Screening the beds is too expensive; also, it may increase damping-off.

Mice have seriously damaged a few southern pine nurseries, but they seem to strike far less often than birds, and on smaller areas within a nursery. Meadow mice, of the genus *Microtus*; pine mice, of the genus *Pitymys*; white-footed mice, of the genus *Peromyscus*; or house mice, varieties of *Mus musculus*, may take seed before or in the early stages of germination, or, much more rarely, injure the roots of seedlings. White-footed mice are notoriously fond of conifer seed. In many instances pine mice are the cause of injury for which moles are blamed. Control requires constant, close inspection to catch the damage when it starts, and immediate use of poisoned bait attractive to the species involved. Recognition of characteristic burrows in grass around the nursery, or of the mice themselves if specimens can be caught (271), aids in selecting the most effective bait.

Moles are often beneficial, since they feed mostly on insects, including white grubs. In seedbeds, however, their tunneling, and perhaps some feeding on roots, may destroy enough seedlings to justify trapping. Suitable traps (659) can be obtained from agricultural supply houses.

In nurseries west of the Atchafalaya River in Louisiana, *pocket gophers* (p. 153) have sometimes injured or killed quantities of seedlings in the fall

by smothering them under mounds of earth, or by eating roots or whole seedlings. They can be controlled by persistent trapping or poisoning.

Crawfish (*Cambarus* spp.) find good nursery sites too dry for them. In poorly drained beds on some soils, however, they have smothered considerable numbers of seedlings under the mud tubes they build up around the mouths of their burrows. Dropping a little turpentine, creosote, or other toxic substance into every burrow controls them, but it is much cheaper and more effective to spray cottonseed or ground corn cobs heavily with DDT and scatter a few seeds or fragments on each square yard of the infested area (225).

Insects and Arachnids ³⁴

Cutworms, the caterpillars of several moths of the family Noctuidae (Phalaenidae), bite off and kill southern pine seedlings in the primary needle and especially in the cotyledon stage, and occasionally attack and kill seedlings in the secondary needle stage.

Attacks on seedlings in the secondary needle stage have been infrequent but sometimes startlingly destructive; during a single week in July, cutworms have killed more than a million longleaf seedlings in one nursery (750). Early season attacks have been less conspicuous, but more frequent, and probably more serious in the aggregate. The meager data available suggest that small populations of cutworms, feeding each year on very young seedlings, may be one of the important causes of low tree percent in many southern nurseries. Furthermore, the possible appearance of large and enormously destructive populations early in any season (198,205, 422, 763) must not be overlooked.

Cutworm injury in the cotyledon stage becomes noticeable as a sudden thinning, either uniform or patchy, of the seedling stand. Cutworm damage is sometimes mistaken for damping-off, but close examination will show that the stems have been bitten completely or partly through at or near the surface of the ground. Where cutworms have eaten the tops of seedlings in the cotyledon stage, tiny seedling stumps in the bare patches may be the only evidence. In the primary needle stage, parts of tops may remain and some stems may be only partly severed. In the secondary needle stage, the cutworms chew both the needle bases and the bark and stems at and just under the surface of the ground.

³⁴ Some of the insecticides recommended here seem likely to become outmoded by the current rapid development of new substances. Nurserymen concerned with insect control should keep informed about improved insecticides by consulting their State agricultural experiment stations and the U. S. Bureau of Entomology and Plant Quarantine, Washington 25, D. C.

Cutworms vary in size, depending on species and stage of development, and reach maximum lengths of 1½ to 2 inches. Caterpillars of most species are smooth. By day they may be found just under the soil among or near injured seedlings or hidden under other vegetation, usually in a curled position (fig. 25, A and B). Their presence may be verified (205) by scattering large handfuls of dock, chickweed, clover, or other plants that they eat, on unsown beds or other bare ground; any caterpillars found within 2 or 3 days on or slightly under the soil surface beneath such plant material will very probably be cutworms.

Cutworms hatch from eggs laid in late fall or early spring. The moths prefer weedy or grassy areas for egg laying. For this reason, areas in fall or winter cover crops or with a growth of early spring weeds may be found heavily infested

with cutworms when made into spring-sown seedbeds. Since cutworms can cross plowed or bare soil more easily than most insects, they may also invade seedbeds adjacent to such cover crops or weedy areas.

Where early season attacks occur regularly, they may be prevented or controlled with chloropicrin, benzene hexachloride, chlordane, or DDT. Where outbreaks occur without warning after the beds have been made, or if the cutworms attack seedlings with secondary needles, the best and perhaps the only recourse seems to be poisoned bait, applied within 24 to 48 hours after the start of the attack. Collection of the worms by hand just after dawn may be effective on small areas (204).

Adult *mole crickets*, *Scapteriscus acletus* R. & H. or *S. vicinus* Scudd. (799), sometimes damage southern pine seedlings, especially small ones, both

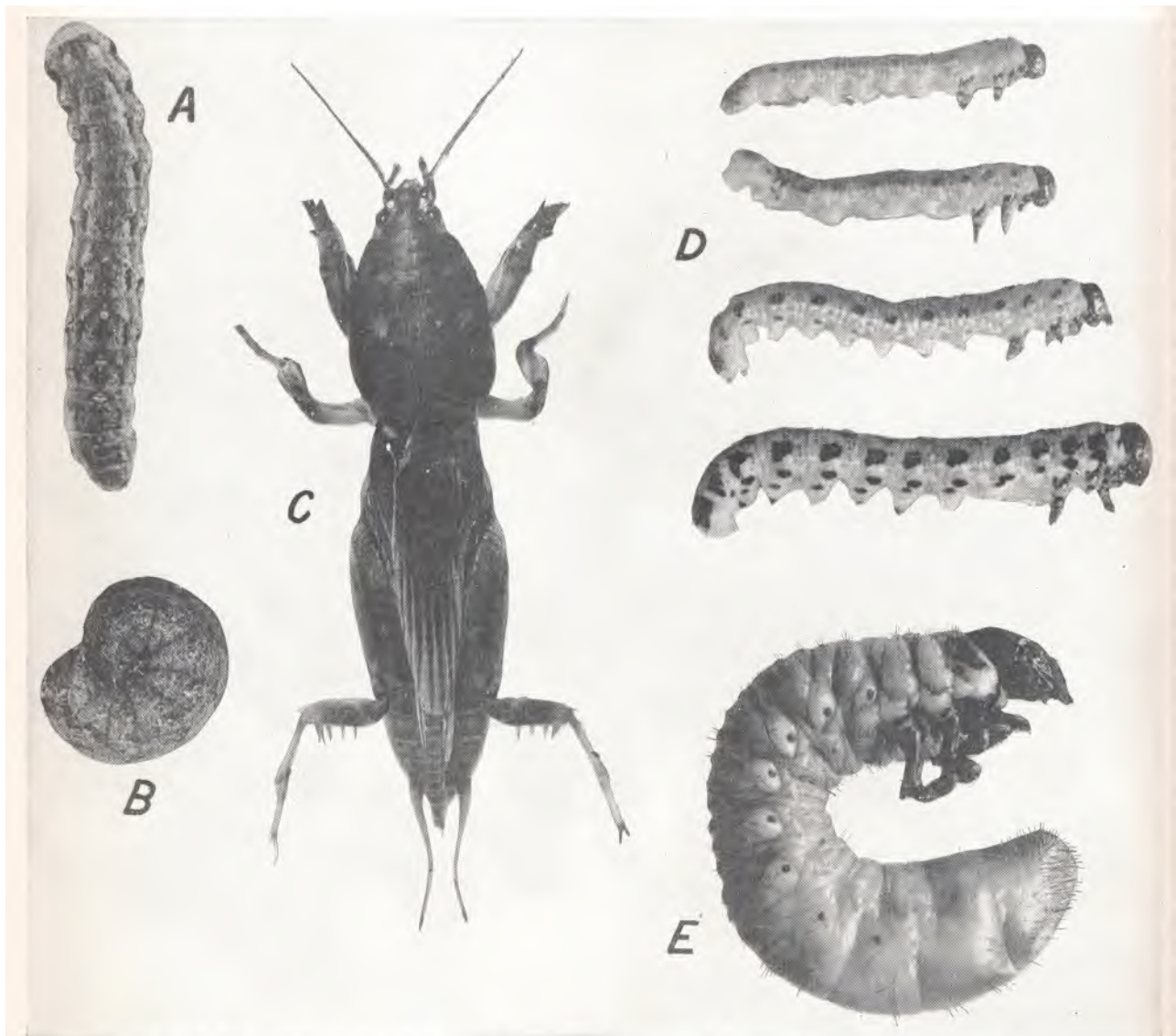

FIGURE 25.—A and B, cutworms; C, adult mole cricket; D, larvae of Leconte's sawfly at various stages of development; E, May-beetle larva (white grub). (Photos courtesy Bureau of Entomology and Plant Quarantine.)

by feeding on the roots and by tunneling the soil surface. The insects are about 1½ inches long and one-fourth inch wide, light brown, yellowish brown, or greenish brown, and have large, beady eyes and stout front legs with shovellike feet (fig. 25, O). Their distinctive shallow tunnels are arched over with cracked or crumbling soil. Mole crickets are most active at night, at temperatures above 70° F. They are usually controlled with poisoned bait, but sometimes with benzene hexachloride, chlordane, chlorinated camphene, or DDT.

The larvae of *Prionid* beetles sometimes cut the roots of southern pine seedlings much as do white grubs, though usually earlier in the season. Injury occurs mostly on newly cleared nursery sites, and usually ceases after the first year. It can be prevented or reduced by removing all roots, stumps, and rubbish where the insects breed and from which they spread to attack the seedlings. Growing a soiling crop before the first crop of pine seedlings presumably would eliminate the hazard (198). Carbon disulfide or methyl bromide will kill the larvae.

Various *harvester* or *mound-building ants*, including the Florida harvester ant, *Pogonomyrmex badius* Latr. (198), defoliate or cut off seedlings in the cotyledon stage, or cover them with earth from the burrows at any time. These ants may be controlled with calcium arsenate, carbon disulfide, hydrogen cyanide, methyl bromide, benzene hexachloride, chlordane, chlorinated camphene, or DDT, as best suits local circumstances. Any colony of Texas leaf-cutting ants (p. 154) within a quarter of a mile of a nursery should be controlled with carbon disulfide or methyl bromide without waiting for signs of injury.

White fringed beetles (*Graphognathus* spp.) are introduced insects whose peculiar life history, great fecundity, inconspicuous and easily transported egg masses, and voracious underground larvae make them a serious agricultural pest in several southern States. They are very dangerous to southern pine nurseries both because of potential direct injury to the seedlings and because the stringent quarantines against them may prevent shipment of stock from any nursery in which they occur. They can be kept out of or eliminated from forest nurseries by trap ditches or by direct treatment of the soil with DDT (14, 17, 124, 494, 807).

The adults are snout beetles, and are flightless because the wing covers are fused together. The beetles are dark gray, slightly less than one-half inch long and less than one-sixth inch broad across the basal half of the wing. The margins of the wing covers are banded with white; there are two pale lines along each side of the head and thorax, one above and the other below the eye; the body is covered with dense, short, pale hairs, longer toward the tip of the wing covers. In side view, the head looks ludicrously like that of a mouse. No male white-fringed beetles have ever been dis-

covered; the females lay eggs without mating. The larvae, which live entirely underground, are yellowish white, legless, sparsely covered with short white hairs; their backs are evenly rounded upward; and their maximum length is about one-half inch. (494, 807.)

Nurserymen in or near zones of white-fringed beetle infestation should consult the State plant board or State entomologist, the U. S. Bureau of Entomology and Plant Quarantine, or the State agricultural experiment station well in advance of sowing and again before lifting in the fall, to get the latest information on quarantines, inspection, and methods of control. Any adults or larvae suspected of being white-fringed beetles should be reported immediately to the same authorities, with specimens (in alcohol) for identification.

Saw fly larvae (p. 155 and fig. 25, D) sometimes kill and more often seriously weaken seedlings by feeding on the foliage in the summer or early fall. A small infestation one year may breed a costly outbreak the next. The larvae should be controlled promptly with arsenate of lead or DDT.

"Red spiders"—the common mite *Tetranychus telarius* L. and related species—may cause extensive yellowing and stunting and occasional dying of southern pine nursery seedlings. "Red spiders" are almost too small to see without a hand lens. Some are yellow or greenish in color. When mature they have eight legs. In hot, dry weather they multiply with extreme rapidity. Their life history makes two or more treatments at 10- to 14-day intervals, with Bordeaux mixture, cube, lime-sulfur, nicotine sulfate, rotenone, sulfur, or Parathion, necessary for control. DDT sometimes increases their number by killing off their natural enemies, and should not be used, even for other pests, if the presence of red spiders is suspected.

White grubs, the larvae of May beetles or June bugs (*Phyllophaga* spp.) of which there are over 50 species in the South, are potentially very serious in all southern pine nurseries. They probably reduce tree percent a little in most nurseries. Several times they have killed 10 to 20 percent of all stock in individual nurseries. In a few nurseries, notably in Florida and the Carolinas, they have caused occasional losses of 25 to 40 percent of all stock and have killed 80 percent or more of all seedlings in large groups of beds. (198, 359, 360.)

The grubs feed on the roots of the seedlings. Attacks in the spring usually kill seedlings outright. The more common summer and early fall attacks kill many seedlings and leave many others unplantable for lack of adequate roots.

Most white grub damage is easy to identify. The injured seedlings, usually in patches, turn from faded green to brown. Dry weather accelerates the change. Sickly and dead seedlings are easily pulled up, and reveal the remains of the characteristically eaten-off roots. Sometimes the feeding is on the laterals or lower taproots, but often all the roots will have been cut off from 1 to 3 inches below the ground surface.

Digging in or around patches of seedlings which have just begun to fade usually turns up the larvae themselves. These vary from one-eighth inch when hatched to 1 inch long when full grown. Young larvae are almost transparent; older ones are a dirty cream color, with hard brown heads, six jointed legs, and nearly transparent abdomens. They bend double when at rest or when disturbed (fig. 25, *E*). They crawl legs downward, in contrast to larvae of the southern green June beetle, which crawl on their backs.

The adults are stout, brownish or blackish beetles usually half an inch or more long. They appear in distinct flights in late March and April and sometimes until late in the summer. At night they swarm around lights.

The insects complete their life cycles in 3 years or in 2 years or less, depending on species and locality. Some authorities attribute nursery damage mostly to grubs in their second year, but Johnston and Eaton found that the larvae of species important in the Carolinas became vigorous feeders 60 to 70 days after egg laying and that the most severe injury resulted from mid-August to late October feeding by first-year grubs from eggs laid after the seedbeds were sown. In the Carolina nurseries, the grubs migrated only 11 to 16 feet during the course of their lives. (359, 360, 624.)

The grubs may be controlled with carbon disulfide, chloropicrin, ethylene dichloride, ethylene dibromide, benzene hexachloride, or chlordane. On very moist soil, mineral spirits applied to kill weeds has sometimes killed many of them (241), but should not be relied upon for complete control. DDT in several instances has failed. Sprinkling or flooding the beds with carbon disulfide or ethylene dichloride emulsions may kill the seedlings as well as the grubs. Poisoning the soil with arsenicals in advance of bed preparation is inapplicable in southern nurseries because the characteristically acid southern soils retain the arsenicals for many years in forms that kill the pine seedlings and most other plants (198, 252, 360, 624, 750). White grubs are at their worst in beds sown to pines for two or more successive years and perhaps have been controlled more than realized by the general practice of alternating pines with soiling crops.

Killing adult May beetles with arsenate of lead as they feed on hardwood foliage around nurseries may reduce egg laying in the beds.

Scale insects of the genus *Toumeyella* seriously weaken southern pine seedlings, particularly loblolly and slash seedlings, by sucking the juices from the needles and stems in the late summer and throughout the fall. They rarely kill or stunt seedlings in the nursery, but most infested seedlings die shortly after planting, even if the scales have been killed just before lifting.

Toumeyella scales are plump, grayish-brown, waxy coverings, varying in diameter from that of a small pencil lead to that of a BB shot. They

conceal the bodies and eggs of the females. The females exude honeydew, which sometimes attracts ants and usually is turned sooty black, on needles and stems, by the growth of a harmless mold.

It is thought that if the scales are killed early enough to permit some seedling growth between spraying and lifting, the seedlings will survive planting. For this reason, and even more to prevent intensification, spread, and repetition of the outbreak, the scales should be controlled as soon as discovered. Miscible oil emulsions generally control the scale without injuring the seedlings; lime-sulfur, lubricating oil emulsion, nicotine sulfate, DDT, HETP, and Parathion may be effective. Complete control usually requires two or more sprayings at about 10-day intervals. Seedlings still infested at lifting time should be culled.

The *Nantucket tip moth* (p. 154) often kills back the top inch or two of loblolly, shortleaf, and even slash pine seedlings in the nursery, in late August or during September, and winters in the dead tips (93, 241, 296).

In most southern pine nurseries, such tip-moth attacks are negligible. They rarely affect more than 1 to 5 percent of the seedlings (usually the tallest), and apparently the seedlings recover without measurable aftereffects. The tip-moth population on most southern pine planting sites is so abundant that loblolly or shortleaf seedlings are sure to become much more heavily infested and severely injured after planting than they were in the nursery; slash seedlings become equally infested but without appreciable injury. Under these circumstances, neither treatment of stock in infested nurseries nor culling of infested individual seedlings is justifiable (93).

Special circumstances, however, may necessitate treating or culling. There may be danger of carrying the insect into tip-moth-free areas, especially from northern Arkansas as far north and east as loblolly and shortleaf pines are planted in the Central States, or quarantines may prohibit shipment of any tip-moth-infested stock. For fall planting of stock from infested areas on sites in uninfested localities, Hall recommends removal of all infested tips or buds before shipment. For spring planting he recommends shipment in screened containers or conveyances, after dipping of all infested stock in white oil emulsion or nicotine oleate at the nursery to kill newly deposited eggs, or else dipping at the planting site. Later work indicates that spraying with DDT every 10 days from first spring appearance of adults until spring lifting may be as effective as and cheaper than dips. Elimination of the insects with either dip or spray depends upon catching them in the susceptible egg and very young larval stages. (14, 29, 36, 93, 296, 487.)

Insects of apparently minor importance include *aphids*, which are sucking insects, and such chewing insects as *Tetralopha* (p. 156), *grasshoppers*, and adults of several species of *beetles*. Aphids can be controlled, if necessary, with nicotine dust

or nicotine sulfate ; *Tetralopa* and the beetles with arsenate of lead ; and grasshoppers with poisoned baits. Many of the multipurpose insecticides have also been reported effective against these and other minor insects, except that DDT tends to increase aphids rather than control them.

Nematodes

Two types of microscopic or nearly microscopic nematode worms may be serious pests in southern pine nurseries. The gall-forming ("root-knot") nematode, *Heterodera marioni* (Cornu. 1879) Goodey, 1932, although it attacks pine seedlings, does so infrequently and seems to cause negligible damage. It is important chiefly because it is capable of destroying green manure crops of several commonly used species ; where it occurs, resistant varieties of these green manure plants must be used (129) . Certain species of free-living nematodes may be much more serious on the pines themselves. In 1947 they were discovered to be strongly associated with, if not the direct cause of, a "root rot" which had thrown a 25-million tree U. S. Forest Service nursery out of production. They may be the underlying cause of puzzling ailments in some other nurseries.

Controls for free-living nematodes are still in the developmental stage, though in the nursery mentioned, fall sowing of longleaf and certain improved fertilizer practices with longleaf, slash, and loblolly pine have somewhat reduced injury, and both chloropicrin and ethylene dibromide have given good control (426) .

If seedlings show knotty or galled roots and especially if undiagnosable late-season "root rots" are associated with poor general development, late-season mortality, and poor survival after planting, it is suggested that: (a) Specimens of seedlings in various stages of the injury be sent to the State agricultural experiment station and to the U. S. Bureau of Plant Industry, Soils, and Agricultural Engineering, Washington 25, D. C., to be examined for nematodes; and (b) the injured beds be resown to pines the following year after treating portions with chloropicrin, ethylene dibromide, or sodium cyanide and ammonium sulfate and leaving other portions untreated as checks. Cyanimid and methyl bromide are possible alternative nematocides. If root knot occurs on green manure crops, the State agricultural experiment station should be consulted for nematode-resistant varieties.

Fungus and Other Diseases

Damping-off is probably the most serious southern pine nursery disease. It affects all southern pines. Annual losses of 1 to 10 million seedlings have been recorded in several individual southern pine nurseries, and 50, 80, and 100 percent losses in particular groups of beds are not uncommon. Damping-off is caused by fungi of several species,

one or another of which may kill seedlings from the very start of germination until at least 6 or 7 weeks after emergence, and may kill longleaf seedlings 4 or more months after germination. The commoner species kill southern pine nursery seedlings under a wide variety of climatic and soil conditions. Damping-off of one or more southern pines has been traced to one or several species apiece of *Botrytis*, *Diplodia* (*Sphaeropsis*), *Fusarium*, *Pythium*, *Rhizoctonia*, and *V. Verticillium*; W. C. Davis found *Rhizoctonia* sp. most frequently associated with damping-off of longleaf pine over a wide territory. S. H. Davis found that *Sclerotium bataticola* Taub., a common organism in many southern pine nursery soils, caused damping-off of four northern pines. Species of *Phytophthora* and *Cylindrocladium* are suspected of causing damping-off of southern pines, and still other fungi may also cause the disease. (221, 222, 223, 224, 251.)

Five distinct forms of damping-off affect southern pine nursery seedlings.

1. "Preemergence damping-off" kills seedlings while they are still beneath the bedcover, probably often while they are still inside the seed coats. Its importance often may be grossly underestimated because a sparse seedling stand is the only sign of its presence visible to ordinary inspection. It may merge into later and more easily recognized forms of damping-off, and should be suspected when they occur or when nursery germination falls far below laboratory germination percent. Where preemergence damping-off is anticipated, its actual occurrence often may be demonstrated by comparing the stands on plots sown in the fall, or very early in the spring, or treated with formaldehyde, with stands on late-sown or untreated plots.

2. The most familiar form of damping-off attacks southern pine seedlings in the cotyledon or very young primary-needle stage, while they are still succulent. It affects them singly at times, but more often in small groups or irregular patches. The roots of the infected seedlings, or at least the upper parts of the roots, die and turn watery brown. The stems wilt and shrivel ; the affected parts of the stems turn rather dark, dirty greenish or purplish, shading off gradually into the normal red or green unaffected parts. Seedlings other than longleaf topple over limply; most freshly germinated longleaf seedlings that have damped-off flatten out on the ground like little rimless wheels. Losses from this form usually decrease rapidly about 4 to 6 weeks after emergence. (222, 224, 302, 750).

Care must be taken to distinguish the two forms of damping-off just described from damage by cutworms.

3. "Top damping-off", sometimes but not always associated with conspicuous splashing of infected soil, may affect the tops of slash, loblolly, and shortleaf seedlings to a much greater extent than their roots, at a later stage than the preceding

form, even as late as May or June. It is particularly likely to affect seedlings in overdense stands.

4. "Sand splash" is a form of damping-off of longleaf pine equally likely to affect newly germinated seedlings and those up to 4 months old whenever surface soil is deposited against them or among their cotyledons or needles. Apparently infection enters the seedlings through parts normally above ground, from the surface soil which has come in contact with these tissues. The growth habit of the stemless longleaf seedlings increases susceptibility to this form of damping-off, in which the tips of the cotyledons and needles, and the portions of the roots more than three-fourths inch underground, remain apparently healthy for some time after the bases of the cotyledons or needles have become infected (222).

5. A form of late damping-off is designated as "root rot" by some investigators (224). This form of the disease differs from top damping-off and sand splash in that the causative organism is active principally or entirely below the normal surface of the seedbed. It occurs when pine seedlings are from 3 to 7 weeks old, or older, and have developed stems stiff enough to remain upright for one to several weeks after the seedlings have died. Again, the seedlings may not die, but may suffer repeated loss of the youngest portions of the roots, or of the deepest portions of the taproots, with or without a stunting of the tops, and sometimes with unusual growth of lateral roots or prolific formation of new roots just above the killed portion of the main root. The more familiar form of damping-off in the succulent stage may merge imperceptibly into this type of "root rot."

Control of damping-off is difficult and uncertain; "the manipulation of shades and control of watering to which freedom from disease is ascribed by many nurserymen are far from being panaceas. It is impossible or impracticable on many sites to keep damping-off within reasonable limits without soil treatments. The soil treatments that have been developed all have limitations" (224). It is almost impossible to make any statement about incidence or control of damping-off without running into conflicting evidence either in the literature or in practice (7, 60; 95, 110, 222, 223, 224, 292, 302, 399, 438, 598, 612, 613, 614, 780, 782, 783). The difficulty of control is intensified by variations in nursery conditions which make the damping-off problems of each nursery peculiar or unique. The following facts bearing on the control of damping-off among southern pines seem, however, to be well established.

Prompt spraying with Semesan and perhaps with bordeaux mixture may control top damping-off or sand splash, but these are better controlled by care in bed making, sowing, covering and cover removal, watering, weeding, cultivation, and maintenance of soil organic matter. The other three forms of damping-off seem controllable only by the same cultural practices, by soil treatments

applied at or before sowing time, or by a combination of the two.

Selection of soils more acid than pH 6.0, or artificial acidification of soil less acid than 6.0 with sulfuric acid, aluminum sulfate, or other substances, may prevent damping-off by several species of fungi, but fails to control and may even increase damping-off by others, particularly *Rhizoctonia* spp. Further acidification of already acid soils may make mineral nutrients less available to the pines, and in extreme cases may injure the pines directly.

Treatment of the soil with formaldehyde has often, though not always, controlled premergence damping-off. It seems ineffective against top damping-off and sand splash. Allyl alcohol (p. 79) has also shown promise as a means of controlling premergence damping-off (426).

Treating the seed with plant growth substances or fungicidal dusts has given virtually no control of damping-off of southern or other pines.

Low vitality of the seed seems invariably to predispose the seedlings to damping-off.

Undecomposed organic matter in any appreciable quantity, very abundant organic matter in any form, or abundant nitrogen in any form and concentrated inorganic nitrogen in particular, or lime, or wood ash, if present during and for some weeks after germination, is extremely likely to increase damping-off. Because of the deficiency of nitrogen and especially of organic matter in many southern nursery soils, their addition at or near seeding time cannot be entirely ruled out, but it should be moderate, cautious, and guided by test applications. If possible, they should be applied well before sowing (perhaps in connection with soiling crops the previous year), or as top or side dressings after the seedlings have outgrown the danger of damping-off.

November and early December (but not October) sowing, as compared to spring sowing, considerably reduces damping-off of longleaf pine. Early spring as against late spring sowing has reduced damping-off of all southern pines in some years in some nurseries.

Sowing broadcast or in broad bands instead of in narrow drills reduces sand splash of longleaf pine, as do all measures which reduce movement of surface soil and its lodgment on or against the seedlings. These measures include leaving part of a pine-straw cover as mulch, reduction of soil wash by proper grading and drainage, increase of soil organic matter, use of seedbed cover other than soil, avoidance of cultivation, and substitution of chemical for hand weeding.

In combating damping-off of southern pines, a more general clue than the foregoing facts may be found in the fundamental work of Leach on damping-off of garden and field crops (403). Leach attacked the problem by exposing four species of host plants, known to differ in temperature requirements for optimum early growth, to four

species of damping-off fungi, also known to differ in temperature requirements for optimum growth, in different combinations at several temperatures. The results showed that *the relative rates of host-emergence and pathogene-growth determined the extent of damping-off*. When, at a given temperature, the host plant germinated and grew rapidly and the fungus grew slowly, damping-off was negligible or light. When temperatures were such that the host plant developed slowly and the fungus rapidly, damping-off was severe.

Exactly the same principle may govern damping-off of southern pine seedlings in the preemergence and succulent-stage forms. It seems to explain many of the inconsistencies observed in the occurrence and control of damping-off in southern nurseries, especially since not only temperature but also moisture supply, pH concentration, nitrogen supply, and several other influences manifestly affect, favorably or unfavorably, the relative growth rates of pine seedlings and fungus.

For example, the preference of some damping-off fungi for near neutral and of others for strongly acid soil (222, 223, 598, 612, 613, 614) may explain why soil acidification is sometimes highly effective (60) and sometimes useless (222).

Again, longleaf pine seed germinates best at relatively low temperatures (p. 62). The principal damping-off fungus attacking longleaf seedlings appears to be *Rhizoctonia* sp., a "high temperature" pathogen (598, 612, 613, 614). In the light of these facts, the severe damping-off of longleaf sown late in the spring or in October, and the relatively slight damping-off of longleaf sown in early spring or in November, are in harmony with Leach's findings.

As further examples, a high concentration of readily available nitrogen in the soil at the time of germination may increase damping-off primarily because it accelerates the growth of damping-off fungi more than that of pine seedlings. Again, severe damping-off of seedlings from old, incorrectly dewinged, or otherwise weakened seed (222), may be explained by the characteristically slow emergence and slow early growth of such seedlings. Leach reports a closely parallel case of severe damping-off of spinach from seed weakened by storage, as contrasted with that from fresh seed (403).

Close study of the conditions under which damping-off is most prevalent and severe in any nursery, and of those under which seed germinates most rapidly and the seedlings grow most vigorously, may frequently make possible the application of Leach's principle in controlling damping-off even without identification of the fungus involved.

Southern fusiform rust, the second most serious southern pine nursery disease, is caused by *Cronartium fusiforme* Hedgcock and Hunt, which infects, and fruits on, oak leaves in the spring (fig. 26, *A*); from the oak leaves passes to and infects the pine nursery seedlings; persists in the seedlings through the summer; and results in swollen cankers or galls on the seedling stems in the fall (fig. 26, *B*). It apparently kills or stunts few seedlings in the nursery, but seedlings infected in the nursery practically never survive planting (fig. 27). Prevalence of the rust on southern pine nursery seedlings with respect to species, places, and years, is practically the same as in southern pine plantations (pp. 157-160) (658, 663, 664).



FIGURE 26.—A, Telia of *Cronartium fusiforme* on underside of oak leaf in spring—a heavy but not extreme infection. (Photo courtesy G. G. Hedgcock.) B, Fusiform-rust cankers on 1-0 slash (left) and longleaf pine seedlings in fall. (Photo courtesy U. S. Bureau of Plant Industry, Soils, and Agricultural Engineering.)



FIGURE 27.—Comparative survival of slash pine without (row to left) and with visible rust cankers (blank row behind stake in center) when lifted and planted.

Nursery rust infections totaling 10 to 20 percent of all slash or loblolly seedlings large enough to plant have been common, and 35 to 60 percent have been reported; infections of 2 to 15 percent have been recorded for longleaf pine.³⁵ As many as 8 million otherwise plantable slash seedlings have been culled and destroyed in one nursery in 1 year because of fusiform-rust infection. Expansion of the slash and loblolly planting program since 1947 has greatly increased the seriousness of the rust problem in southern pine nurseries. (394, 655, 658, 665.)

The only indications of fusiform-rust infection readily visible on seedlings in the nursery are the characteristic stem swellings (fig. 26, **B**). On slash and loblolly seedlings they usually are spindle-shaped and centered at the point where the cotyledons were attached or an inch or two above it—rarely below it. Incipient swellings on these species often are easier to detect by touch than by sight; older ones are fairly conspicuous and frequently marked by one or more lateral branches arising from or near each swelling. On longleaf seedlings the swellings usually are turnip-shaped rather than spindle-shaped and largely or wholly below the needles and sometimes partly below the root collar (203, 665).

³⁵ Although *Cronartium fusiforme* infects shortleaf pine, fusiform rust on this host seems to be localized to western North and South Carolina. Furthermore, this rust has never been recorded on shortleaf nursery stock.

Although seedlings become infected in the spring, conspicuous swellings seldom develop before September or late August, even on slash and loblolly seedlings of vigorous growth or from early sowings. On slash and loblolly from late sowings or of slower growth, and on longleaf seedlings, the swellings may not appear much before lifting time. By the time the swellings appear, the seedlings are long past saving. The percentage of stem-swollen seedlings in unsprayed beds or plots in bad rust years is the best single index to the need for systematic rust control in any particular nursery, and should be recorded as a guide to protection policy in future years.

Control measures must be timed to fit precisely the intricate life history of *Cronartium fusiforme* (pp. 157-160). Pine nursery seedlings can become infected with the rust only in the spring, and only from spores produced on leaves of oaks. They are likely to become heavily infected, however, whenever temperatures between 60° and 80° F. coincide with relative humidities approximating 100 percent for 18 hours or more during the time in which telia (fig. 26, **A**) are present in great numbers on oak leaves within a mile or two of the nursery. Production of telia on neighboring oaks and occurrence of weather favorable to infection of the pines vary enormously in different nurseries and years. Conditions likely to result in heavy infection are easy to recognize. They consist of numerous oaks around the nursery, the development of telia on their new leaves, and general likelihood or specific forecasts of weather favorable to spore formation. When all these combine to make hazard high, control measures should be applied with special care.

Control requires weekly spraying with FERMATE (preferred), ZERLATE, or BORDEAUX mixture throughout the period of possible infection of the pines. Even if it means applying the first one to three sprays on the seedbed covers instead of directly on the seedlings, spraying must start *before* telia appear on the oak leaves—by March 15 at the latest; a week after the first oak buds in the vicinity have burst, or when the daily average temperature reaches 57° F., if either of these occur before March 15. It must continue until the middle of June. A good spreader and plenty of spray pressure (275 to 325 pounds per square inch) are essential. Infection is most likely during wet weather; therefore, if rain interrupts regular weekly spraying, spray should be applied as soon as the foliage is dry enough to retain it and the ground is dry enough to permit use of the spray rig. In bad rust years, the omission of one spray may waste the benefit of all the others. The prewar cost of 12 to 15 weekly sprayings totaled about 20 cents per thousand trees produced. Such spraying should be standard practice on slash and loblolly pine, and frequently on longleaf, in any nursery in a locality of high rust hazard or in which 10 or 15 percent of fusiform-rust infection has ever been observed. (655, 658, 665.)

Culling visibly infected seedlings at lifting time (p. 98) cannot take the place of spraying. Although it improves average survival in the plantation, culling saves none of the money spent in growing the infected seedlings. Neither does it keep the infected seedlings which have failed to develop swellings by lifting time from getting into the plantations, and in the rush of lifting some of the trees with visible swellings also inevitably get by the graders (663).

Late sowing of slash and loblolly pine substantially reduces fusiform-rust infection (665), but does not give complete protection when conditions favorable for infection occur in May. And late sowing is likely to increase losses from damping-off, *Sclerotium bataticola*, and inadequate seedling growth.

Controlling fusiform rust by eradicating all oaks within 1,500 feet of the nursery has proved expensive and ineffective (665).

Brown-spot needle blight, caused by *Scirrhia acicola* (Dearn.) Siggers, is the commonest and most serious late-season nursery disease of longleaf pine. It affects the secondary needles only, and ordinarily appears in June or July, but sometimes as early as May or not until August or later. Unless controlled, it grows worse until the seedlings are lifted. Infections too light to weaken longleaf seedlings in the nursery may become more intense after planting and cause ultimate failure. Serious outbreaks sometimes occur on loblolly and slash pine nursery stock—on slash pine particularly beyond its natural range or on very dry or infertile nursery sites (750)—*but* much less frequently than on longleaf. The disease sometimes attacks shortleaf and other southern and some exotic pine nursery stock practically throughout the southern pine region, but all species suffer most seriously in certain territories shown in figure 4 (652).

Brown-spot infection in the nursery is easily recognized by the ordinary external spots on the needles (p. 161); the irregular distribution of the yellowing in the early stages of these spots distinguishes the disease from the uniform yellowing of chlorosis. "Bar spots" also occur on infected nursery seedlings, but much less commonly than the ordinary type, and less commonly than on seedlings in plantations. The manner and pattern of infection in nurseries are essentially the same as in plantations (p. 161). Infection naturally is likely to be heaviest in nurseries near or immediately adjacent to heavily infected stands of longleaf pine.

Brown spot is easily controlled by spraying the seedlings with practically any fungicide, at frequent enough intervals to protect new foliage as it develops. Spraying with bordeaux mixture (p. 208) has been standard practice for many years. A final spraying just before lifting is important, particularly in nurseries where brown-spot infection is naturally severe and most particularly if infected longleaf seedlings are already present

on or near the planting site. Four to six sprayings, including the one at lifting time, usually control brown spot satisfactorily, at a total cost (prewar) of 3 to 9 cents per thousand seedlings. In extreme cases, however, a dozen sprayings have been required.

Needle cast caused by *Hypoderma lethale* Dearn. may kill the foliage of southern pine nursery seedlings, especially loblolly, much as it does that of planted and natural trees (p. 163). Needle cast is potentially dangerous and should be controlled promptly when discovered. Repeated sprayings with double-strength (8-8-50) bordeaux and a good adhesive have been recommended (223).

Sclerotium bataticola Taub. is a common soil-inhabiting fungus consistently associated with, if not actually the cause of, much seedling mortality from June or July through August, in nurseries from Georgia and Florida west to Arkansas and Texas. In extreme cases it may kill 50 percent of the seedling stand. The fungus seems to affect shortleaf pine most frequently and severely, and longleaf least.

According to Sleeth³⁶ symptoms and signs of *Sclerotium bataticola* infection on southern pine nursery seedlings are "wilting of new growth at the top, followed by death of the stem and needles below; frequently a constriction of the stem near the ground; and black sclerotia immediately beneath the bark and in the dead tissue; a distinctly dry, dead appearance of the roots. Except for the sclerotia, the trouble might easily be taken for a combination of heat and drought injury." (The sclerotia are small, specialized structures of the fungus tissue, visible to the naked eye, but more easily distinguished with a hand lens.) The fungus, characteristically tolerant of high temperatures (103, 171), is most likely to occur on southern pine seedlings in the hottest and driest weather. Injuries caused by hand weeding and especially by hoeing and cultivation intensify infection.

Midday watering to reduce surface-soil temperatures is the most direct means of controlling *Sclerotium bataticola*. Mulching (as by leaving part of a pine-straw bedcover) and increasing soil organic matter have both been beneficial; so has the avoidance of late sowing (665).

Quarantining of infected nurseries or beds, or disinfection of the stock before shipment, is not recommended, as the fungus occurs widely on other plants and can flourish also on decaying vegetable matter, without living hosts (171).

The *Texas cotton root rot*, caused by *Phymatotrichum omnivorum* (Shear) Duggar, attacks southern pines in plantations (p. 164), but does not seem to affect 1-year-old southern pine seedlings even in nursery soils in which it is abundantly present. In the southern pine region, this

³⁶ Bailey Sleeth, unpublished memoranda, U. S. Bureau of Plant Industry, Soils, and Agricultural Engineering.

rot occurs no farther east than southwestern Arkansas and eastern Texas. Authorities see little danger in shipping seedlings from infected beds to planting sites within the range of the root rot, but shipment to areas east of the known range seems questionable procedure (362). Attempts to eradicate the rot by acidifying the nursery soil with sulfur have not been wholly successful. Infected nursery sites can be avoided by testing them, before development, with cotton or other rot-susceptible plants.

Miscellaneous late-season *root rots* may be caused by damping-off fungi (including *Phytophthora* spp., which cause resinous exudations and resin-soaked tissue at the point of first infection), *Torula marginata*, *Poria cocos*, *Armillaria mellea* (Vahl.) Quel. (which forms black shoestring-like fungus strands in the soil), and, doubtless, by other fungi (95, 110, 023, 302, 351). Any root rot discovered late in the season or at lifting time should be observed and recorded carefully. Root rots affecting any considerable percentage of the seedlings merit investigation by pathologists.

"Smothering fungi" of the genus *Thelephora* form conspicuous purplish or brown cups or collars around seedling stems, usually in the late fall or winter, and especially on moist sites. Although they sometimes cause much anxiety to nurserymen not familiar with them, these fungi do not seem to be parasitic (110). The cups rarely smother southern pine seedlings, and usually collapse or disappear with the passage of time or the coming of dry weather. Control with bordeaux spray has been suggested (95, 223), but apparently not tried on southern pines.

Chlorosis is a yellowing of part or all of the seedling foliage resulting from the breaking down or nonformation of the normal green pigment. It may appear in June, May, or even earlier, but is commonest during the hot summer months or early fall. Often, though not always, it accompanies or is followed by poor growth or stunting. In some nurseries it reappears in the same places year after year. It seems to be most common, persistent, and detrimental in shortleaf pine seedlings, and least so in longleaf.

The extent to which chlorosis causes the stunting with which it is associated is not known. Apparently it does not directly kill seedlings in the nursery. No records are available of the plantation survival and growth of chlorotic or formerly chlorotic seedlings.

Uniform yellowing distinguishes chlorosis from incipient brown spot. Lack of browning, of lesions on needles or stems, and of any fruiting bodies distinguishes it from later brown spot and from needle cast and *Sclerotium bataticola* infection. It is difficult to tell from some forms of heat and drought injury, and from "red spider" injury except when the mites themselves are discovered.

Chlorosis has been attributed to an immense number of climatic influences and physical, chem-

ical, and microbiological peculiarities of the soil (95, 110, 223). In southern pine nurseries it has appeared following application of commercial fertilizers, heavy applications of compost, and the plowing under of green manure crops. It has appeared along terraces—sometimes on the ridges and sometimes in the channels. It has followed dry periods as well as excessive rains. Clearly defined patches of chlorotic seedlings often mark the courses of old paths and roads, the foundations of old houses, and spots where brush and stumps have been burned.

Most chlorosis clears up spontaneously. Some responds promptly to one or two sprayings, at 10-day intervals, with a 1-percent solution of ferrous sulfate ("copperas"). Probably ferrous sulfate should be tried on any patches extensive enough to cause concern. Beyond this, the only treatment that can be recommended is to try to identify and correct the abnormal soil condition with which the chlorosis is associated. Some check on the after-effects of chlorosis on plantation survival and growth is advisable.

Enlarged lenticels occur on southern pine nursery seedlings, usually late in the growing season, much as they do on planted trees (p. 164). They usually indicate a need for improving the drainage, but are otherwise harmless and may be ignored.

Mechanical Injury

Serious mortality during the growing season or heavy culling at lifting time often results from mechanical injury to the seedlings during cover removal, cultivation, hoeing, or weeding. Prevention or control of mechanical injury is usually easy. The main problem is to differentiate mechanical injury from other injuries, and trace it to its source.

Mechanical injuries to seedling stems usually involve either bending (rarely breakage), or removal of bark. Heat lesions and fungus infections leave the bark in place, but discolor it. Mechanical injury seldom causes discoloration unless fungi subsequently invade the injured tissues.

Rapid bark healing at the point of injury is characteristic of mechanical injuries but not of fungus infection, although swelling may occur above injuries of both types.

Insect injury, as by beetles or grasshoppers, may also remove bark and be followed by healing, but usually occurs at several levels up and down the stems or is concentrated at the tops. By contrast, mechanical injury usually occurs near the ground, sometimes just under the soil surface, and is concentrated at the level of a hoe stroke or of some projection on a cultivator shoe.

Heat and drought injuries occur in or follow hot, dry weather. Mechanical injuries appear after some cultural operation, regardless of weather.

Heat injuries tend to concentrate on the south sides of seedlings, particularly on the south sides

of beds or the north sides of openings in the stand. Mechanical injury usually is independent of compass direction.

Insect and fungus injuries affect seedlings anywhere in the drills, or may occur principally in the interiors of drills. Mechanical injury occurs mostly along the outside margins of drills.

Heat and drought usually affect the smaller seedlings particularly. Insects and fungi, depending on species, frequently affect mostly small seedlings or mostly large ones. Mechanical injury affects seedlings largely according to position rather than size.

Root injuries by insects and fungi occur at varying and frequently at considerable depths ; white grub injury is a good example. Mechanical injury usually affects only the roots nearest the surface.

Chemical injuries to needles, as from fertilizer concentration or from sprays, merely brown or kill the needles. Mechanical injury crushes or cuts them or tears them out.

If examination of seedlings by the unaided eye or with a hand lens does not show clearly whether the injuries have been caused mechanically, a number of small test plots should be given a variety of special treatments and reexamined frequently and carefully for contrasting results. The alternative causes of injury suspected will suggest appropriate test treatments, such as omission of cultivation, extra careful hand weeding, shading to reduce soil temperatures extra watering, and special spraying with insecticides and fungicides.

Nutritional Deficiencies and Toxic Effects

Size of seedlings.—Within wide limits, absolute size of the seedlings is not a very reliable guide to the adequacy a nutrition. When, however, small seedlings survive less well than equally small seedlings from other nurseries, deficient nutrition should be suspected. It should also be suspected if the seedlings are too small to be

planted conveniently or to compete with the vegetation on ordinary planting sites, or if the nursery stock fails conspicuously to attain the same size as in former years. Retarded growth often is a sign of nitrogen deficiency.

"Troughing" consists of failure of the seedlings in the middle of the bed to grow as well as those along the edges. In mild cases, the retardation in growth involves only the later secondary needles. In serious troughing, secondary needles fail to form on the seedlings in the middle of the bed, and the stems (of species other than longleaf) make less growth. In extreme cases, summer and fall mortality is heavier in the middle than along the edges. Any of these stages gives a bed the appearance of a shallow trough (fig. 28). Marked troughing, formerly attributed to insufficient watering (750) and still chargeable to it in some instances, has proved to be in most cases a clear sign of nutrient deficiency.

Weeds.—Other things being equal, a weak, sparse, unaggressive growth of weeds is a sign of low soil fertility. It is sad but true that weeds are most troublesome when nutrient levels are at their best for pines.

Color changes.—Yellowing, fading, and browning are symptoms of several injuries previously discussed. A deficiency of nitrogen may cause yellowing less distinct than chlorosis, but still easy to see; such yellowing, usually accompanied by stunting, often occurs when sawdust is added to the soil without also adding enough nitrogen to supply the micro-organisms breaking down the sawdust. Phosphorous deficiency (223) may cause seedlings to turn purple or blue before cold weather (p. 83) and growth often stops almost completely when the color changes.

Browning or burning by insecticides or other sprays, or as a result of excessive use of late-season fertilizers or failure to wash fertilizers off the foliage, is generally easy to recognize. Injuries affect mostly the newest and most tender tissues, or those most directly exposed to contact with the

FIGURE 28.—Moderately severe troughing in slash pine seedbed; note retarded growth (shown by dip of rope) and lack of secondary needles in center of bed. Troughing is a common sign of inadequate soil nutrients.

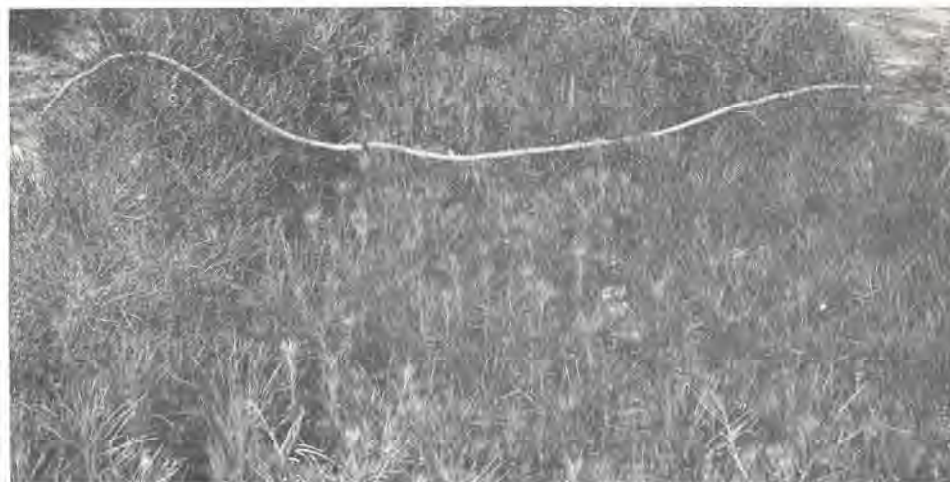

F-322895

chemicals. With few exceptions, the signs of injury develop within a few days (sometimes within a few hours) after treatment, and are intensified by heat and drought.

Poor initial survival after planting.—If not caused by incorrect treatment during lifting, shipment, or planting, or by some definite plantation injury (pp. 148-164), poor initial survival after planting may often be the result of inadequate or unbalanced mineral nutrition in the nursery (p. 109).

SEEDLING INVENTORY

Nursery stock produced for sale must be inventoried months in advance of lifting, as a safeguard against accepting more orders than can be filled. Stock produced for home use must be inventoried in time to permit detailed preparations for field planting. Southern pine seedling inventories, particularly where production is reckoned in millions, usually consist of estimates made by counting the seedling in 1- by 4-foot samples at intervals along the beds. Inventories must not cost more than a few cents per thousand trees shipped. Final estimates showing numbers of plantable trees within 5 percent are greatly to be desired, and are acceptable bases for nursery cost accounts and for technical operations requiring good records of stock quantities. Dubious or less accurate final estimates often require checking or correction by counts or new estimates during lifting and packing.

Common obstacles to meeting these standards for southern pine seedling inventories are : Irregularity of seedling spacing or seedling stand density; late-season injuries, as from white grubs or drought; failure of a considerable percentage of seedlings to attain plantable size or grade until the very end of the growing season ; and the difficulty or impossibility of detecting some damage, such as root injuries and fusiform rust, until the stock has been lifted.

In practice these obstacles can be largely overcome by : (a) Mixing the seed thoroughly before sowing (p. 75) ; (b) making two inventories, one in July and one in September or October; and (c) correcting one or both inventories by means of data derived from experience or from special samples.

The July inventory is needed for preliminary planning of stock shipments and field planting. It need not be highly accurate, and its cost is kept down by taking only enough samples to give a fair approximation of the total number of living seedlings. The estimate usually is corrected by reducing this total, in the light of past experience, to allow for late-season injuries and usual percentages of culling.

The fall inventory attempts a much closer estimate of the total number of living seedlings and usually also a close estimate of the number of seedlings expected to be plantable at lifting time. In any event, estimates must be reduced to allow for

losses during lifting. These standards necessitate more samples, often more detailed examination of samples, and generally better records of past experience than are required for the July inventory.

If seedling development has varied little from year to year and damage is light, past experience may be a reliable guide to the percentage of seedlings, alive in September or October, that will be plantable when lifted. More frequently, damage is light or is confined to the seedling tops, but seedling development has varied greatly from year to year, or (as in new nurseries) past records are unavailable. Then it is necessary to record, on the basis of top size and condition, the number of plantable seedlings in each inventory sample. Often, root defects make grading by tops unreliable, and then some of the inventory samples must be dug and the number of plantable seedlings in each determined by examining both roots and tops.

The total number of living trees in September or October usually can be determined within 5 percent, and often within 2 or 3 percent, at reasonable cost. Numbers of plantable trees are harder to estimate within 5 percent, because of the errors introduced by mechanical injury during lifting and because of the difficulty the man who makes the inventory in October has in grading the same as those who lift the seedlings in December. The U. S. Forest Service's shipping records have nevertheless repeatedly checked October inventories of plantable stock within 4 percent.

Such accuracy can be attained, however, only by following well-established rules (636), based upon sound sampling procedure :

1. Sampling must be applied to tolerably uniform nursery units. Occasionally an entire nursery constitutes such a unit. More often the nursery must be subdivided into several dissimilar units, as "fall-sown longleaf," "spring-sown longleaf" "seed from locality A," and so on, which must be sampled separately. It is especially important to make separate units of portions of the stand which differ greatly in seedling density, even if they are similar in other respects. A large, irregular portion of a compartment in which the stand has been made uneven in density and spacing, as by hail or bird damage, should be mapped out as a unit separate from the rest of the compartment.

2. Sampling must be done with an intensity (table 19) suitable to the size of the unit being inventoried, to the uniformity with which the seedlings are distributed in the beds, and to the accuracy of the estimate desired.

3. If seedbeds are of equal size, equal numbers of samples should be drawn from each. If beds vary in size, the number of samples drawn from each should be proportional to bed length. Except where the total number of seedlings is very large and the beds are unusually small—less than 100 feet long—it is well to draw at least two samples from each bed.

TABLE 19.—Numbers of samples required to inventory nursery units with degrees of intensity suitable under various conditions¹

Size of nursery unit		Total number of samples required to include following percentages of bed areas—						
Number of beds 4 by 400 feet	Number of trees ²	20	10	5	2	1	0.5	0.25
1	50,000	80	<i>40</i>	20	8			
2	100,000	160	80	<i>40</i>	16	8		
10	500,000	800	400	200	80	40	20	
20	1,000,000		800	400	160	80	40	20
100	5,000,000			2,000	800	400	200	100
200	10,000,000				1,600	800	400	200

¹Samples are 1 by 4 feet, across the beds. Bold-faced figures indicate total number of samples suggested for final inventory of uniformly spaced stand or preliminary inventory of very irregular stand. Italic figures indicate total number suggested for final inventory of exceptionally uniform stand or preliminary inventory of ordinary stand.

For extremely irregular stands, intensities of sampling should be increased somewhat above those suggested. For numbers of beds intermediate between those shown, numbers of samples should be interpolated.

² Approximate only, assuming a density of slightly more than 31 trees per square foot.

4. All sample locations must be drawn strictly at random, with absolutely no exercise of personal judgment. Locations may be established by pacing.

5. If plantable seedlings are to be judged on the basis of both roots and tops, a sample of the samples of living seedlings must be selected at random for digging. Ordinarily 20 samples will reveal any important variation in the plantable percent, and digging more than 20 from each unit is expensive. In extreme cases, however, up to 40 per unit may be needed.

6. Counting and recording of numbers of seedlings in samples must be exact. Sampling frames must be used, and workers should have written directions concerning inclusion or exclusion of borderline trees. The only personal judgment permissible in sampling is in classifying trees as plantable or unplantable.

7. The total net length (exclusive of blank stretches) of the seedbeds in the unit being sampled must be measured exactly with a tape; pacing is not accurate enough.

If these rules have been followed, inventory data can be analyzed like those from germination tests (p. 65) to forecast probable upper and lower limits of actual nursery output or to compare the effects of different nursery practices. With seedling inventories, however, in contrast to germination tests, numbers of samples need not be kept constant, and the data are not "transformed."

The step-by-step details of seedling inventories are given on pp. 224-225.

LIFTING, CULLING, PACKING, AND SHIPPING

The lifting season brings a peak load of nursery work. Careful advance planning and timely purchase of equipment and supplies are required to

maintain shipping schedules, which in large nurseries may include a million trees a day. Moreover, since plantation success depends as much upon the quality and condition of the seedlings as upon the way they are planted (p. 121), shipping schedules must be maintained without lowering the technical standards of lifting, culling, packing, or shipping.

Inspection and Certification Before Lifting

It is usually necessary, and always desirable, to have the nursery inspected and the stock certified by the State plant board or equivalent agency (p. 214) just before lifting time. Common carriers will not accept stock for interstate shipment without inspection certificates, and quarantine lines may affect truck shipments within States as well as across State lines. White-fringed beetles, Texas cotton root rot, Nantucket tip moth, and other pests discussed under nursery injuries and their control may give rise to quarantine problems in individual States. Even where there is no legal barrier to shipment, inspection may forestall extensive injury to plantations by previously unsuspected pests.

Protective Sprays and Dips

If the stock is to be planted where rabbits bite off a considerable percentage of seedlings, loblolly, slash, and shortleaf pines may profitably be sprayed with a rabbit repellent just before lifting.

Wherever brown-spot needle blight is appreciable either in the nursery or in plantations, longleaf pine should be sprayed with bordeaux mixture shortly before being lifted. Raw linseed oil, although inconvenient and expensive, seems preferable to other stickers for this final spraying because it lasts exceptionally well.

Dips or sprays at lifting time to control Nantucket tip moth are needed or are effective only under certain circumstances (pp. 88 and 155).

Dips or sprays to increase initial survival by reducing transpiration (p. 132) show some promise, and should be followed up in current literature and by means of local tests.

Lifting

One of the nurseryman's greatest responsibilities is to lift the seedlings without injuring them, and particularly without breaking off many lateral roots (p. 128).

Seedlings in small nurseries, and special lots of stock in large nurseries, are usually lifted by hand. Roots are pruned to 7 or 8 inches (p. 128) either with shovels, as the first step in lifting, or with hatchets or cleavers after lifting. Injury to the roots, including cutting them too short, is kept at a minimum by using sharp, square-edged shovels; by lifting only when the soil is at a moisture content to crumble easily; and by separating the roots gently from the soil.

The tractor-drawn lifters used in large nurseries consist of variously designed and mounted blades set to undercut the seedbeds at a depth of about 11 inches and to loosen the soil without disrupting it greatly or overturning the seedlings. Descriptions have been published (413, 443, 718), and specifications for current models may be obtained from the Regional Forester, U. S. Forest Service, Atlanta, Ga.

Mechanical lifters have the disadvantages of not actually removing the seedlings from the soil, often of damaging the seedling roots, and sometimes of injuring the soil itself. Different nurseries require different lifter designs and operations. Operating lifters on heavy soils when the ground is too dry or too wet, or at too great speed under any conditions, breaks many seedling roots, with consequent mortality after planting (pp. 128-129). Mechanical lifting intensifies the problem of keeping the nursery soil in good physical condition (p. 112). After the lifter has undercut the seedlings, great care must still be used in getting their roots out of the ground, by hand or with forks or shovels, and in root pruning, either by hand or on mechanical grading tables. Supervision of the lifting should include occasional sifting of the seedbed soil, and washing and hand-lens examination of seedlings, to see how many small lateral roots are being broken off.

Grading and Culling

Grading (pp. 102-110) and culling are integral parts of lifting and packing southern pine nursery stock. Culling usually eliminates 10 to 20 percent of the seedlings as below plantable grade, and an additional percentage of higher grade seedlings which have suffered mechanical injury or certain fungus infections or insect infestations.

Grading and culling must be done rapidly to keep roots from drying out, and to maintain shipping schedules and keep costs down. They may be done either at the seedbeds by the workmen who separate the seedlings from the loosened earth, or by graders working in buildings or at portable tables screened with cloth to keep off sun and wind. In large, permanent nurseries, grading in a special building is preferable. It concentrates grading and culling in the hands of fewer men, who can be selected, trained, and supervised better than a large, widely scattered crew. The more uniform temperature and humidity in a building increase working efficiency and reduce stock drying. Maximum efficiency usually is reached by grading seedlings on moving conveyor belts, though such belts are impracticable when many rust-infected seedlings must be removed.

It is customary to cull all seedlings with roots cut or broken off less than 5 inches below the root collar (p. 128). Seedlings with conspicuously split main roots, with broken stems, or with conspicuously stripped lateral roots, root bark, stem bark, or foliage, also should be rejected. Seedlings less severely but still visibly damaged probably should be passed, but, if numerous, should be called to the attention of the lifting crew.

All seedlings infected with southern fusiform rust (fig. 26, *B*) should be culled (pp. 93 and 157; fig. 27), as should seedlings infested with live scale insects.

No general rule can be laid down about culling seedlings with root rot. A few decayed roots probably are inevitable in any lot of stock. Widespread occurrence of rot requires both consultation with pathologists and local test planting of variously infected seedlings and apparently rot-free checks. Culling of seedlings with visible root rot may be necessary in stock offered for sale, or as a precaution against root infection in plantations.

Seedlings lightly infected with brown spot may be passed, but any with a third or more of the needle tissue involved in brown-spot infection may profitably be culled.

Ordinarily, tip-moth infested seedlings may be shipped if otherwise of plantable grade. Under certain circumstances already referred to, however, the injured seedlings should be either top-pruned or culled and the rest either dipped or sprayed.

Most nurserymen cull conspicuously chlorotic seedlings. On the hypothesis that chlorosis results from abnormalities in nutrition this may be sound practice, although proof is lacking.

Seedlings that show traces of *Sclerotium bataticola* but are otherwise normal and vigorous probably need not be culled.

The best evidence available (p. 126) indicates that, during the ordinary safe planting season, southern pine seedlings should not be culled merely because their winter buds have elongated or opened.

Plainly marked specimens both of plantable seedlings and of seedlings culled because of low grade, rust infection, root rot, and various types of mechanical injury should be mounted on boards over the grading table to guide the crew.

Counting

The details and cost of grading and packing depend largely upon whether the seedlings are shipped in bulk or in small lots, and upon whether they are counted. Large companies producing their own stock usually ship in bulk, and base their cost accounts and control of planting upon the October nursery inventory. The U. S. Forest Service uses counts of sample bales to verify the fall inventory and to control bulk shipments of stock from one nursery unit to several different plantations. State forest nurserymen necessarily ship most of their stock in small lots, and have, until recently, felt obliged to count all the seedlings in each lot.

Bale counts.—In checking inventories and controlling shipments by bale count, a record is kept of the number of bales, species by species, for each shipment. Five percent of the bales in each shipment are selected *at random* and opened, the seedlings are counted, and the baling material and seedlings are returned to the baler to be repacked. Repacked bales are returned to the shipment from which they were drawn.

The sample bale counts for each shipment are averaged, and the total number of bales in the shipment is multiplied by the average number of trees per bale to get the total number of seedlings. The total number of seedlings is shown on the waybill accompanying the shipment. On the same document are shown, for each species : (a) The average number of trees per bale for all bales sent to that consignee that season, the current shipment included ; (b) the total number of bales sent him to date; and (c) the total number of seedlings of that species sent him to date.

The nurseryman keeps copies of the waybills. By grouping them according to the nursery inventory units from which the stock was lifted, he can quickly compute the average number of seedlings per bale, the total number of bales, and the total number of plantable seedlings shipped from each unit. The last-named figure is an excellent check on the late-season inventory. If such a check is made on the first units lifted and shipped, the estimates for later units can be corrected fairly early in the planting season. Such corrections are sometimes of great practical help in administering shipment and planting. Frequently also, they lead to better understanding of various nursery injuries; the seriousness of southern fusiform rust in the nursery, for example, came to light in essentially this way.

Correct and careful sampling of either seedbeds or bales can give satisfactorily close estimates of the number of trees in lots of perhaps 100,000 or

more. They are of no direct help, however, in filling orders for 1,000 to 20,000 trees apiece. Consignees receiving such small lots frequently check the counts, and sometimes keenly resent a shortage of 1 percent in a single container. State nurserymen therefore either count the trees shipped to fill such small orders, or include extra trees as a margin of safety.

Seedling counts.—*General practice*, when stock is counted exactly, is to tie loblolly, slash, and shortleaf seedlings in bundles of either 50 or 100 for later baling. Longleaf seedlings are tied 50 in a bundle. The bundles must be compact and firm enough to be handled rapidly, and the mass of roots must not be too thick for good contact with wet moss or moist ground during shipment or heeling-in. Bundles of all species except longleaf are tied with soft, rather thick cotton string just above the root collar, often by means of electric tying machines. The peculiar shape of longleaf seedlings necessitates tying by hand with two connected loops of soft string, one around the roots and one around the needles.

Hand counting into 50- or 100-seedling bundles ordinarily is justifiable only in small or temporary nurseries or with experimental stock. Usually it is most efficient to make hand counting and tying a separate operation following grading and culling. Except when percentages culled must be determined, only plantable seedlings are counted.

Where seedlings from large nurseries are shipped by count, grading, culling, root-pruning, and counting usually are carried out simultaneously on mechanical grading tables. Tables may be used to advantage for root-pruning and counting the graded stock even where fusiform-rust infection makes it impossible to grade and cull on them.

The grading tables are equipped with broad, moving belts, usually one on each side of the table, and running for 20 to 40 feet along the table top. Wooden strips bolted at right angles across each belt form "pockets" in each of which five seedlings may be placed. Workmen fill the pockets with plantable seedlings as the belt goes by, placing the root collars in line with marks on the belt or on the wooden cross strips. A revolving blade at the end of the table prunes the roots at a point 8 inches below the root collars, and a fine spray moistens the stock preparatory to packing. Gaps between sets of 20 pockets permit lots of 100 seedlings to be separated as they drop from the belt. Descriptions of grading and counting tables have been published (599, 718), and latest designs may be obtained from the Regional Forester, U. S. Forest Service, Atlanta, Ga.

Once the counted seedlings have been tied in uniform bundles, orders are filled by counting out the requisite numbers of bundles. Summarizing the shipment totals gives the total nursery output, which is checked in some nurseries (599) by using recording electric tiers.

Counting by weight.—Moving averages of the weights of random 100- or 1,000-seedling samples from a particular lot of stock or of numbers of seedlings in random 10-pound samples are used in some nurseries to fill 10,000- to 20,000-seedling orders by weight instead of by count. From 1 to 5 percent of extra seedlings, by weight, are added to each shipment as a margin of safety. With orders of these sizes, such weighing, even allowing for the extra trees added, is cheaper than counting. The method is reliable, however, only with fairly uniform stock.

Packing

Efficient packing of stock for shipment requires : (a) Packing material that has a high moisture-retentive capacity and will keep the roots wet with minimum weight and bulk and permit storing packed seedlings for several days without injury ; (b) lightweight wrappers or containers that will prevent moisture loss, stand rough handling, and, in shipments by mail or express, safeguard adjacent objects from wetting; (c) packing material and wrappers of low initial cost, and preferably capable of salvage and reuse; and (d) materials and equipment (including bale binders) that will permit packing at high speed without injury to the trees and with a minimum of labor and of stops for repairs.

The favorite packing material in southern nurseries is sphagnum moss. Granulated peat and bagasse (shredded sugar-cane pomace) have also been used, apparently with good results. Sphagnum may be bought dry, in bales, from florists' supply houses or direct from producers ; sometimes it can be collected locally from bogs. One 2- by 2- by 3-foot bale of dry moss will pack twenty to twenty-five 1,800-seedling bales of slash pine, and one 13- by 19- by 31-inch hamper of wet locally collected moss will pack approximately seven similar bales of shortleaf. Peat may be purchased from the same sources as sphagnum moss, and bagasse from some manufacturers of wallboard. Other packing materials have been described (434, 547, 718, 750), but their merits for packing southern pine stock do not seem to have been compared critically with those of sphagnum moss.

The II. S. Forest Service nurseries and several State nurseries pack southern pine seedlings in 60-pound bales each consisting of two 1- by 2- by 24-inch wooden slats, a 2- by 6-foot wrapper, two metal straps, and enough moist sphagnum moss to separate and surround the layers of seedlings (fig. 29). Directions for baling are given on page 227.

A 60-pound bale made as described holds 1,200 to 1,800 longleaf seedlings, and 1,500 to 3,000 seedlings of other southern pines. When the slats and wrappers were returned from the planting site to the nursery and used a second time, the material for such bales, at prewar prices, cost 4 to 8 cents per thousand trees, depending on the size of the

stock. Sixty-pound bales are shipped 100 per 3-ton truck, making 120,000 to 250,000 or more seedlings per load.

Root Exposure, Nursery Storage, and Shipment

From the time the seedlings are first undercut by the lifter blade until they are planted, there is constant danger that the stock may be injured by exposure (especially of the roots) to sun and wind, by heating or drying during shipment or temporary storage, or by other causes, such as freezing. The principal safeguard against such injuries up to and during shipment is the nurseryman's skill and care in lifting, handling, and packing the stock.

The first source of danger comes when beds are undercut with the lifter several hours or days before the stock is removed from the soil. The danger is slight if the soil drops back into place behind the blade without cracking much or otherwise exposing the seedling roots or covering the tops. If the lifter seriously displaces the seedlings, they should be removed from the bed immediately.

Throughout lifting, grading, and packing, there is danger of weakening or killing the stock by exposing the tops and especially the roots to dry air, sun, and wind (p. 130). Although southern pine nursery stock of all species stands exposure remarkably well, exposure is never beneficial and should be avoided to the greatest extent possible. Exposure of the roots (except to freezing) probably does negligible harm so long as the roots remain visibly moist. Lifting, grading, culling, counting, and packing southern pine nursery stock need not and usually do not expose the roots beyond the danger point.

Excessive drying of stock can be prevented by lifting and packing it or heeling it in promptly after undercutting the beds ; by keeping seedlings out of the wind and sun and by covering the roots with canvas, wet burlap, or loose earth ; and by dipping, spraying, or watering the seedlings at the first hint of drying of the roots. There is little evidence, however, that it does any good to rewet the roots after they have been dried by serious overexposure; such belated watering merely makes it more difficult to recognize injured seedlings by examination (118), and is questionable practice.

Since freezing of seedling roots may seriously reduce survival (p. 148), stock should not be handled bare-rooted in the open during freezing weather.

Heating of the stock in the bales, as a result of the physiological activity of the seedlings, is another source of danger. Packing in a cool, shady place, moistening the stock with cool water during packing, using bales that leave the seedling tops exposed, keeping the bales shaded and cool but

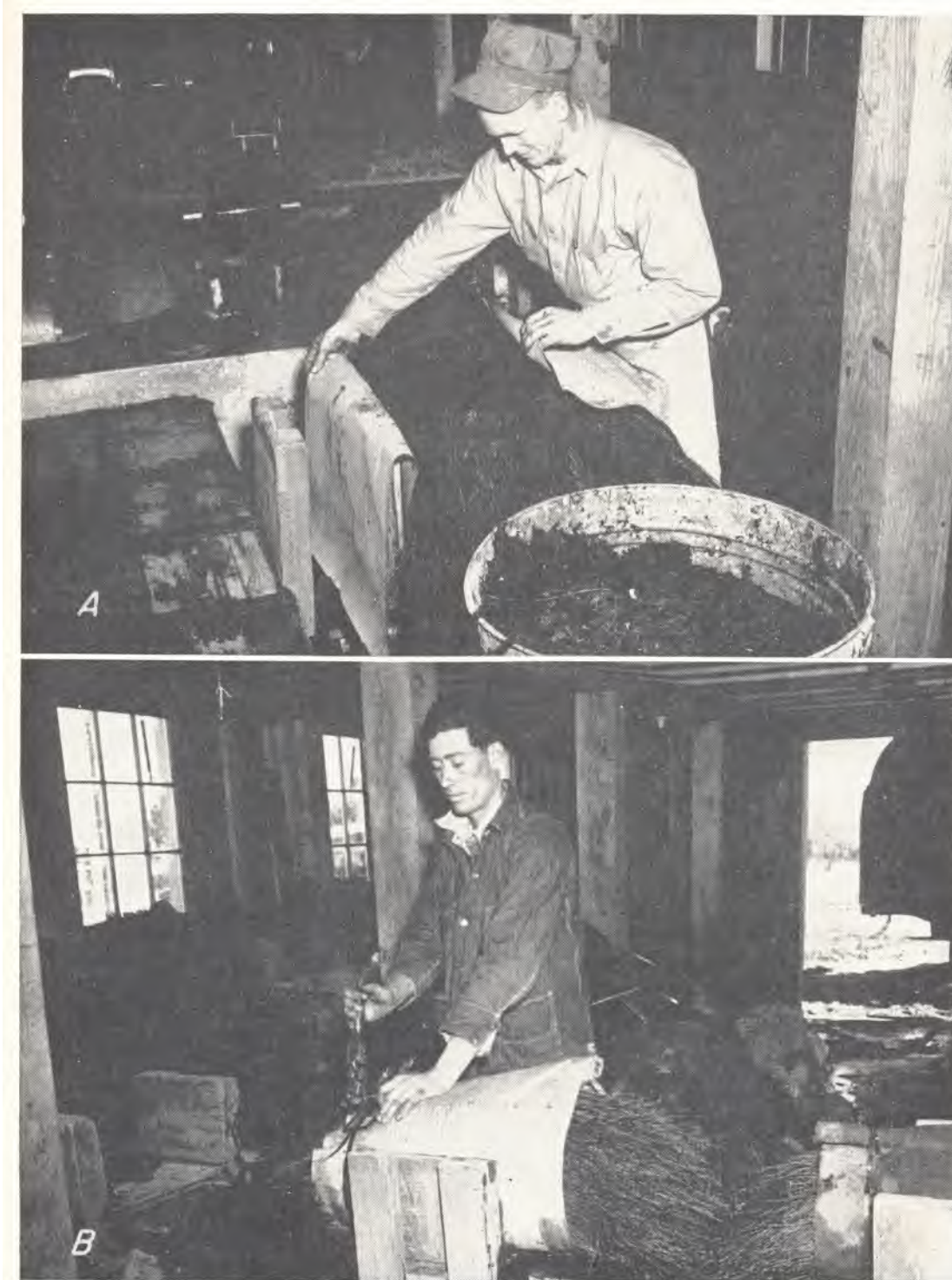

F-465679, 465680

FIGURE 29.—Packing 60-pound bales of longleaf pine seedlings in paper-lined burlap and wet sphagnum moss, in racks at end of mechanical grading table. *A*, Bale built up and ready for completion of wrapping. *B*, Tightening and fastening metal strap with hand-operated fastening machine. Note ends of wrapper rolled tightly around upper of two slats that stiffen the bale.

exposed to gentle air movement, leaving bales in piles for as little time as possible, and watering the bales through their open ends, all reduce the danger of heating. In shipping by truck for more than 200 miles, it is U. S. Forest Service practice to unload the trucks once or twice en route and water the bales.

Although much southern pine nursery stock is delivered to the planters within 24 to 48 hours after it has been lifted, bad weather and other obstacles often require storage of a considerable percentage of the stock at the nursery for several days or even weeks. Any interruption to the lifting schedule may necessitate storage for at least a day before grading and packing. State nurseries frequently build up a 2 or 3 weeks' reserve of graded stock before starting shipment, lest bad weather prevent filling scheduled orders.

Southern pine seedlings can be stored for a week or more in U. S. Forest Service type bales, with negligible harm, provided the bales are kept moist and are not allowed to heat (p. 129). In extreme cases, bales may keep seedlings in good condition for a month or 6 weeks, but success for such long periods is uncertain, especially toward the end of the lifting season. Storage in other forms of containers is not known to have been tested systematically.

The most common method of temporary storage in the nursery is by heeling-in. The technique is exactly like that for heeling-in at the planting site (p. 226), except that the cultivated nursery soil usually is better suited to the purpose than most soils at planting sites, and water is more readily available. The three essential precautions in heeling-in are that the layers of seedling roots be not more than 3 or 4 inches thick; that the soil come above the root collars of all seedlings but not far up onto the foilage of any; and that roots and soil be kept continuously moist. Heeling-in overnight and for periods up to 10 days or 2 weeks causes little or no injury. Periods up to 4 weeks may have no ill effects, and may even improve survival (p. 130). Freezing weather apparently harms heeled-in stock less than it does freshly planted stock (p. 148).

Storage of southern pine nursery seedlings in still water, as in tubs, may kill them overnight (p. 130). Too few experiments have been made with cold storage of southern pine nursery stock to warrant recommendations concerning it.

GRADES OF NURSERY STOCK

The problem of satisfactorily defining southern pine seedling grades has proved to be complex. It is too important to be disregarded, but a thoroughly satisfactory solution cannot yet be given. The following discussion is limited to grades of 1-0 seedlings, since other classes of southern pine nursery stock are little used except in parts of the Central States (157, 158, 164, 265).

Grades, also, are considered apart from visible injuries caused by mechanical means, insects, or diseases.

The whole concept of nursery stock grades is based upon seedling capacities for survival and growth after planting. Nursery stock grades developed to date have attempted to judge these capacities by visible characteristics, including size. For convenience, since they depend upon morphology or external form, they are called *morphological grades*. But mere bigness or presumably desirable form of seedlings has not always assured plantation success. Too many plantations established under favorable conditions with seedlings of high morphological grade have survived poorly. Evidently the effects of nonvisible characteristics within seedlings may be as important as the effects of size and external form. To distinguish them from morphological grades, nonvisible, internal differences are termed *physiological qualities*.

Morphological Grades

The first systematic studies of southern pine nursery stock grades were begun with loblolly and slash pines in 1924-25, at Bogalusa, La., and were later extended to other species and areas. The seedlings were graded according to the presence or absence of secondary needles and of winter buds, the stiffness of the stems, the proportion of the stem having true bark, and the relative size of the seedlings as compared with the size of other seedlings in the same beds.

The specifications by which morphological grades were originally distinguished set no exact size limits between plantable and nonplantable seedlings, nor did they rigidly exclude seedlings without secondary needles from the plantable stock (750). To standardize grading by large, inexperienced crews, to simplify supervision and inspection of grading, and to reduce disputes concerning grades of stock bought and sold, many agencies later established minimum root-collar diameter limits—and made the presence of secondary needles a rigid requirement—for all seedlings classified as plantable.

In their simplest form, present morphological grading rules specify that healthy, unbroken, 1-0 southern pine seedlings shall be culled if they lack secondary needles, the root system is less than 5 inches long, or the diameter at the root collar is less than three-sixteenths of an inch in longleaf pine or less than one-eighth of an inch in loblolly, slash, or shortleaf (table 20). For shortleaf pine in the Central States, Chapman (164) suggests somewhat different rules, requiring minimum stem diameters of 2/20 inch and minimum heights of 4 inches, and distinguishing higher grades by various ranges of heights for various diameters or ranges of diameters measured in twentieths of an

inch at a point 1 inch above the ground. Top-root ratios, the calculation and publication of which was for many years popular among nursery investigators (344, 381, 648, 649, 741, 742, 743, 750), in addition to having certain theoretical weaknesses (159, 602, 647), have never proved useful in grading southern pine nursery seedlings and have not been included in the grading rules.

The rules in table 20 have several excellent characteristics. Their use, although it requires close, alert observation, involves little personal judgment; they can therefore be enforced uniformly by nurserymen and foremen, and can be used with little dispute in buying and selling stock. They

are simple to learn, and can be applied with the speed necessary in commercial lifting and packing. They can be applied directly, in advance of planting and without injuring the stock, to each and every seedling. They undeniably eliminate seedlings too small to plant and many seedlings too slender and weak stemmed to plant with good chance of success. For application to southern pine nursery stock, they appear superior to any other rules so far developed.

Despite these advantages, however, neither the grading rules in table 20 nor morphological grades in general can be given an unqualified recommendation.

TABLE 20.--Specifications of morphological grades ¹ of uninjured ² 1-year-old southern pine seedlings

Species and grade	Usual heights ³	Thickness of stem at ground	Nature of stem	Bark on stem	Needles	Winter buds
Longleaf:	<i>Inches</i>	<i>Inches</i>				
1.....	12 to 16.....	$\frac{1}{4}$ to $\frac{1}{2}$ or larger.			Abundant. Almost all in 3's or 2's.	Usually present; usually with scales.
2.....	8 to 15; 6 to 8 if stem and buds are good.	At least $\frac{3}{16}$.			Moderately abundant; at least part in 3's or 2's.	Buds with scales usually lacking; some without scales usually present.
3.....	Less than 8.....	Less than $\frac{3}{16}$.			Scanty; short; often none in 3's and 2's.	Not present.
Slash:						
1.....	6 to 14.....	$\frac{3}{16}$ or larger.	Stiff; woody.	Usually on entire stem.	Almost entirely in 3's and 2's.	Usually present.
2.....	5 to 8; sometimes 12.	At least $\frac{1}{8}$.	Moderately stiff.	On lower part at least; often all over.	Part at least in 3's and 2's.	Occasionally present.
3.....	Usually less than 6.	Less than $\frac{1}{8}$.	Weak; often juicy.	Often lacking.	Practically all single; usually bluish.	Almost never present.
Loblolly:						
1.....	5 to 12.....	$\frac{3}{16}$ or larger.	Stiff; woody.	Usually on entire stem.	Almost entirely in 3's.	Usually present.
2.....	4 to 7; sometimes 10.	At least $\frac{1}{8}$.	Moderately stiff.	On lower part at least, often all over.	Part at least in 3's.	Occasionally present.
3.....	Usually less than 5.	Less than $\frac{1}{8}$.	Weak; often juicy.	Often lacking.	Practically all single; usually bluish.	Almost never present.
Shortleaf:						
1.....	4 to 10.....	About $\frac{3}{16}$.	Stiff; woody. Usually a crook at ground level; often branching.	Usually on entire stem.	Almost entirely in 3's and 2's.	Usually present.
2.....	3 to 6; sometimes 8.	About $\frac{1}{8}$.	Moderately stiff; often with crook and branches.	On lower part at least; often all over.	Part at least in 3's and 2's.	Occasionally present.
3.....	Usually less than 4.	Distinctly less than $\frac{1}{8}$.	Weak; often juicy; often straight.	Often lacking.	Practically all single; bluish.	Practically never present.

¹ Grades 1 and 2 usually considered plantable, and grade 3 culled.

² Any seedlings with roots less than 5 inches long should be considered as grade 3 (culls), regardless of the quality of the tops.

³ Needle lengths of longleaf pine seedlings; stem lengths of other 3 species.

Success and Failure of Morphological Grades

During the first few years in which they were applied to southern pine seedlings, morphological grades seemed to work well. In the original studies of graded loblolly and slash pines at Bogalusa, for example, seedlings of the higher grades, during the first 5 years after planting, consistently survived and grew better than those of the lower grades; they also suffered somewhat less rabbit damage (750). Because of their combined better survival and growth, the grade 2 seedlings in these studies produced 2.0 to 13.6 more cords of merchantable pulpwood per acre at 20 years, and the grade 1 seedlings produced 10.9 to 27.8 more cords, than did grade 3 seedlings (757).

As grades came into wider use, however, stock graded as plantable often failed to survive well even when planted carefully in favorable weather and on good sites. Such failures by no means proved that the grades were at fault; indeed, most people assumed that greater refinements of planting technique would end the trouble. The failures were common enough, however, to cause doubt concerning the reliability of the grades.

The survival of the "untreated check" portions of numerous survival studies shows the doubt was well founded. From 1922 through 1941, the Southern Forest Experiment Station established 298 such untreated checks containing more than 57,000 seedlings, all graded as plantable. All had roots pruned to 6 to 8 inches; all were bar-planted on favorable sites, in favorable weather, during the regular planting season; and no lots were appreciably injured in any way during the year after planting.

From 1922-23 through 1926-27, the period during which morphological grades were coming into use, 38 of these untreated check plantings, involving the 4 principal southern pines, were made at Bogalusa, La. Among these there was a maximum range of only 26 percent in survival; the lowest survival was 72 percent.

During the 1934-35 through 1937-38 planting seasons, poor survival and some failures of graded stock were beginning to be reported throughout the South. In these 4 seasons, 48, 102, 18, and 43 check lots, respectively, were planted on the Johnson Tract, an area of 1,200 acres near Alexandria, La. The first three seasons the lots were equally divided between slash and longleaf pine; in 1937-38, a few lots of loblolly and shortleaf pine were included. All the stock came from one nursery, but from many widely separated and variously fertilized parts of its 50 acres. In 1934-35, survivals varied by 51 percent, with minimum survival 38 percent; the best and poorest lots were both slash pine. In 1935-36, when 102 lots were planted, survivals varied by 68 percent, with minimum survival 29 percent; the best and poorest lots were both longleaf pine. In 1936-37, when

only 18 check lots were planted, survival again varied by 68 percent, with minimum survival only 28 percent; the best lot was slash and the poorest was longleaf pine. In 1937-38, survival varied by 37 percent, with minimum 63 percent; best and poorest survivals were both slash pine, but the survival of shortleaf pine, represented by only 8 lots, varied by 33 percent.

During the period 1938-39 through 1940-41, 49 untreated check lots were planted close to and in some cases among the previous outplantings on the Johnson Tract. The seedlings were drawn from the same nursery as those planted during the previous period, and were graded by the same rules, but had been grown on a limited area of uniform soil and uniformly favorable soil treatment, instead of at widely scattered points throughout the 50 acres. In marked contrast to the highly variable survivals in any one of the four previous years, the total range in initial survivals of all four species in all 3 years of the later period was only 13 percent, and the lowest survival among the 49 lots was 87 percent.

Some Johnson Tract check lots of one or another species survived 91 to 100 percent in 1935-36, 1936-37, and 1937-38; some survived 89 percent in 1934-35. This makes it seem unlikely that better weather conditions caused the general improvement in survival during the period 1938-39 through 1940-41. It seems more likely that during the later period the capacity for survival of the seedlings in the check lots was uniformly high, and that during the earlier period, when the seedlings were being drawn from the entire nursery instead of from a limited area of uniformly good soil, the morphological grading rules failed to eliminate seedlings of low capacity for survival from a considerable number of the check lots. Similar failures of the grading rules to eliminate seedlings of low survival capacity seemed to explain, at least in part, the poor survivals in southern pine plantations in general during the middle and late thirties.

A number of new grading studies, established from 1934-35 onward, caused further doubt about the ability of morphological grading rules to distinguish high capacity for survival. In these studies the grade 1 seedlings (table 20) generally made the best *growth*, as in the earlier studies at Bogalusa and elsewhere. In conspicuous contrast to the grade 1 seedlings in the earlier studies, however, the grade 1 stock in these later studies generally *survived* less well than the grade 2 stock, and sometimes less well than the grade 3 stock, which is ordinarily culled.

Slash pine stock planted on the Harrison Experimental Forest, in south Mississippi, in 1941, after grading in accordance with table 20, illustrates both the superior growth and the inferior survival characteristics of grade 1 stock in the later studies. Five years after planting, the survivals and average heights of these slash pines were: Grade 1, 29 percent and 14.4 feet; grade 2,

61 percent and 13.4 feet; grade 3, 53 percent and 11.0 feet. Here the seedlings of intermediate morphological grade clearly excelled those of highest grade in capacity for survival, and approached them in growth. Such superiority of medium-sized overlarge southern pine seedlings has been observed from Arkansas and Missouri to North Carolina at various times since the early thirties (164, 173, 438, 488), and medium-sized stock of other species has shown similar superiority (91, 557, 784, 787, 791).

When nurserymen and planters realized that some trees classified as plantable actually had a poor chance of surviving, they began to suspect also that some of the stock culled might be capable of high survival. Their suspicions were strengthened when culls given away at a few nurseries were reported to have survived as well as or better than the seedlings sold as plantable.

The possibility that appreciable quantities of good stock were being culled raised a serious question. Culling part of a particular lot of seedlings increases the cost per thousand of those kept for planting; culling a large percentage may add exorbitantly to costs (fig. 30). Culling to meet the standards in table 20 usually adds at least 10 or 20 percent—sometimes much more—to any percentages culled for injury during lifting and for disease. If seedlings culled in accordance with table 20 are capable of good survival, culling them increases the total cost of planting without improving the results.

It was suggested that the apparent failures of morphological grades from about 1935 onward might be the result of growing seedlings in much more uniform stands than were attainable at the time the grading rules were first developed. A sec-

and suggestion was that mechanical lifting had increased the breakage of lateral roots over that caused by hand lifting. This was found to be true in some cases (p. 128), but did not explain the high survival of seedlings classed as culls under the morphological grading rules. A third suggestion was that the rules given in table 20 specified the wrong root-collar diameters to differentiate plantable from cull stock. A fourth was that the morphological grades set forth in table 20 took insufficient account of variations in top dormancy and in the formation and opening of winter buds.

Critical Test of Morphological Grades

Whatever its cause, the apparent weakness of the morphological grades seemed serious enough to require special investigation. The last two suggestions in the preceding paragraph promised the most effective approach to the problem. In 1937-38 a study of longleaf pine grades and another of slash pine grades (fig. 31) was established on the Johnson Tract to see whether either the dimensions of the seedlings or variations in the apparent dormancy of their tops were causing inconsistencies in survival.

In the longleaf study, the "plantable" and "cull" grades of table 20 were broken down into 8 subgrades distinguished by size and needle development as specified in figure 32. In the slash study, the "plantable" and "cull" grades of table 20 were broken down into 12 subgrades distinguished by size, needle development, and apparent top dormancy, as specified in figures 33 and 34.

All the experimental planting stock for both studies was taken, from one nursery. Stock of each species was drawn from each of two beds, alike in seed source and date of sowing, but differing in seedling development. Within each species, the bed having a higher percentage of morphologically "plantable" seedlings and a generally more thrifty appearance was called bed I, and the other, bed II. The difference between the two slash pine beds was especially conspicuous.

Species by species, 1.00 seedlings of each subgrade were lifted from each of the two beds, and planted in balanced, randomized blocks to permit rigorous analysis of the results. The total numbers of seedlings planted were 1,600 longleaf and 2,400 slash. One well-qualified man graded all the stock.

In the longleaf study the bed I and bed II stocks did not differ significantly in survival at the end of the first growing season in the plantation. Therefore they were averaged together, subgrade by subgrade, with the results shown in figure 32. There were conspicuous differences, several of them significant or very significant, in favor of subgrades with secondary needles as against those without, and particularly in favor of the intermediate as against the largest and smallest size classes. One of the longleaf subgrades that would

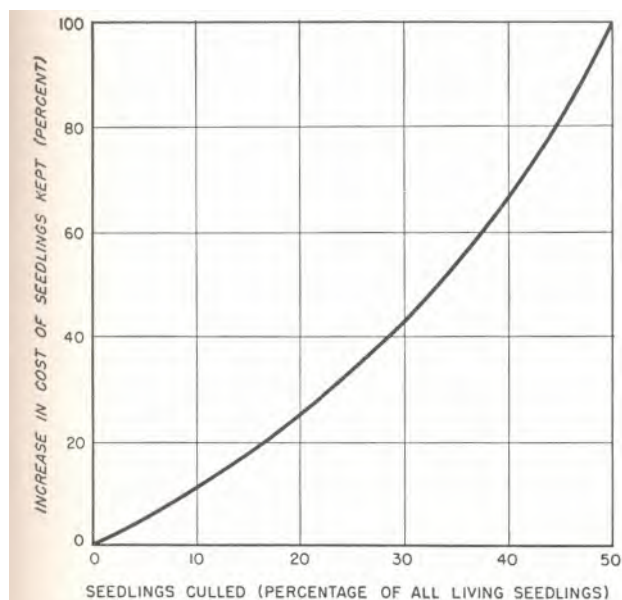

FIGURE 30.—Effect of degree of culling upon cost of seedlings kept.



FIGURE 31.—Representative samples of (A) longleaf pine seedlings and (B) slash pine seedlings planted in the 1937-38 grading studies on the Johnson Tract. Background lines are 3 centimeters (1 3/16 inches) apart. Exact dimension limits of seedling subgrades are given in figures 32 to 34.

commonly have been culled survived 6 percent better than the largest "plantable" seedlings, but this superiority was not statistically significant.

In the slash pine study the bed II stock survived 88 percent, 86 percent, and 81 percent (average of all 12 subgrades combined) after one, two and one-half, and eight and one-half growing seasons in the plantation, as against 71 percent, 64 percent, and 59 percent for bed I stock. The differences in favor of the bed II stock at the three successively later dates were therefore 17, 22, and 22 percent, all very significant.

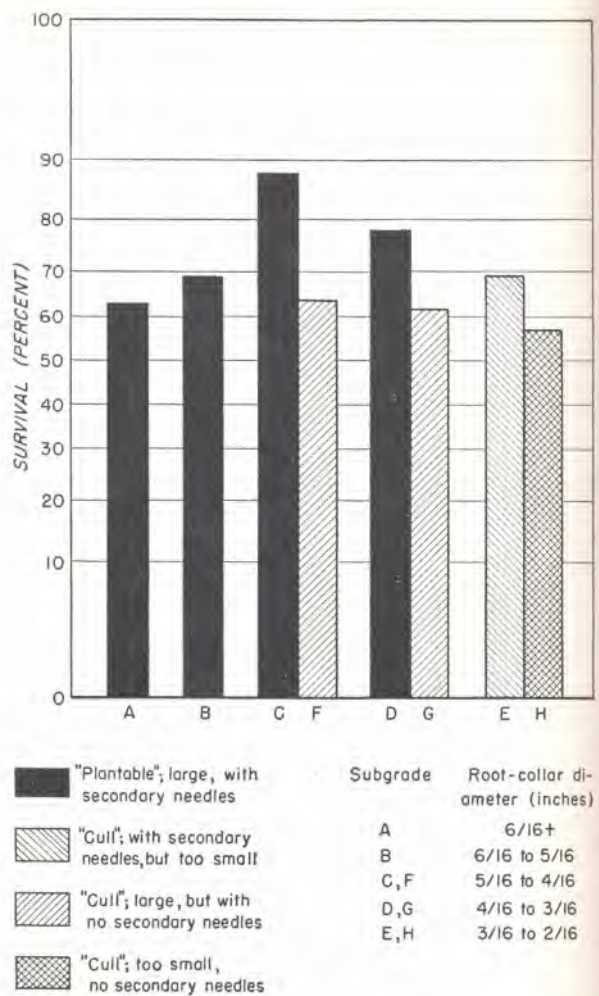

FIGURE 32.—Average survivals of longleaf pine seedlings from one nursery by morphological subgrades, bed I and bed II stocks combined, at end of first growing season after planting.

Averaging the two slash pine stocks together, subgrade by subgrade as was done for longleaf, showed few important and no consistent differences in survival attributable to differences in apparent dormancy. It did show, as in longleaf, a clear superiority of intermediate over large sizes. It also showed that two "cull" subgrades survived significantly better than one or more other "cull" subgrades, and much too well (87 and 80 percent) to throw away (757).

The most startling results appeared in comparing the 12 slash pine subgrades separately by bed I and bed II stocks (fig. 33). Here many of the larger differences are statistically significant. The economic importance of the differences is obvious. With 1 exception out of 12 comparisons, the bed II stock survived better, subgrade by subgrade, than the bed I stock. In nine instances the bed II excelled the bed I subgrade in first-year survival by 15 percent or more. Furthermore, five of the six

"cull" subgrades from bed II survived better than two of the six "plantable" subgrades from bed I; one of them survived better than the very best bed I subgrade.

Reexamination two and one-half growing seasons after planting showed that these differences in survival in favor of the bed II stock had increased. At this time, the average heights of the

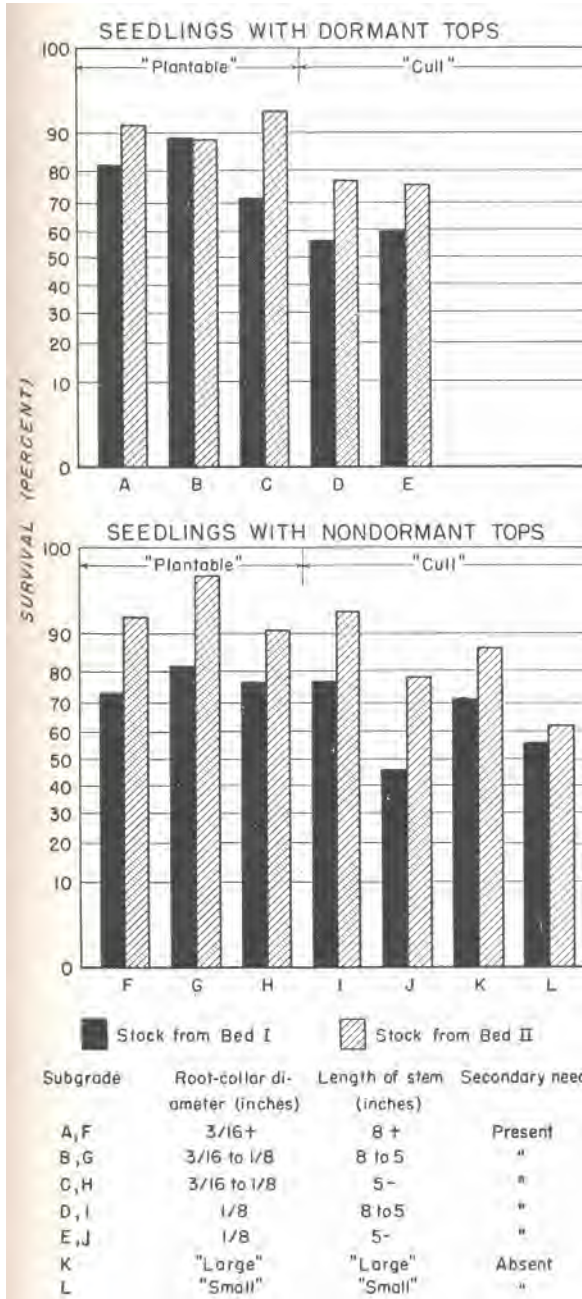

FIGURE 33.—Average survivals of slash pine seedlings from one nursery, separately by morphological subgrades and by bed I and bed II stocks, at end of first growing season after planting. Despite the higher percentage of "plantable" seedlings in the bed I stock, and its more prepossessing appearance, the bed II stock survived much better.

larger slash pine subgrades (unlike many of their survivals) generally excelled those of the smaller subgrades. Without exception, however, every slash subgrade from the bed II stock had grown very significantly better than the corresponding subgrade from the bed I stock, and all the bed II "culls" had grown better than one or more of the bed I "plantable" grades (fig. 34).

After eight and one-half growing seasons in the plantation, the bed II stock excelled the bed I stock in height, subgrade by subgrade, and more conspicuously than ever. By this time the surviving bed II stock, all subgrades combined, averaged 3.2 feet taller than the surviving bed I stock. This is equivalent to an average height increase, in less than 9 years, of three-fifths of a pulpwood bolt per tree, and on 37 percent more trees. Almost half

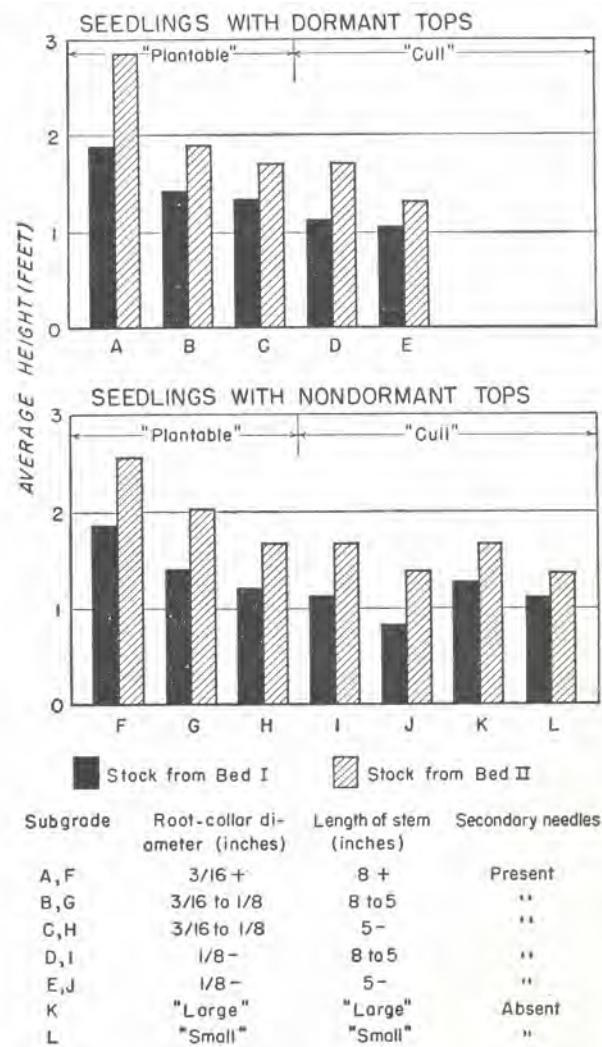

FIGURE 34. Average heights of slash pine seedlings from one nursery, two and one-half growing seasons after planting, separately by morphological subgrades and by bed I and bed II stocks. Despite the higher percentage of "plantable" seedlings in the bed I stock, and its more prepossessing appearance, the bed II stock grew much better.

of it was made by seedlings which, under a strict interpretation of the grading rules in table 20, would have been thrown away.

In the two studies described, the survivals and growth of the several subgrades within the generally accepted morphological grades showed that under the conditions of these particular studies :

1. The root-collar diameter limits between "plantable" and "cull" seedlings in table 20 would result in the culling, because of size alone, of many longleaf and slash pine seedlings capable of high survival and good growth. (This confirmed the suspicions mentioned on p. 105.)

2. The apparent dormancy or nondormancy of slash pine seedling tops had few significant and no very consistent effects on survival.

3. Although longleaf seedlings without secondary needles survived less well than those with secondary needles (fig. 32), many slash pine seedlings without them had excellent survival (fig. 33).

4. The largest seedlings of both slash and longleaf pine survived less well than those of intermediate size. (This confirmed the general observations and published studies cited on p. 104.)

5. Under the circumstances of the 1937-38 studies, the morphological grades were unreliable. The grading rules neither threw together seedlings of the same capacities for survival and growth, nor distinguished them with any certainty from those with different capacities, even within one bed. In the slash pine study the grading rules indicated the capacities of seedlings in two different beds so poorly that much the better lot of stock was considered the less plantable and thrifty (p. 105). It was concluded that similar failures of the same grading rules, applied to seedlings from the same nursery, might well have accounted for much of the variability in survival of the check lots (p. 104) planted on the Johnson Tract during 1934-35 through 1937-38. If so, such failures might also have accounted for much variability in survival of stock from other nurseries.

Physiological Qualities

The 1937-38 grading studies demonstrated one other fact of more general and far-reaching importance than the five discussed in the preceding paragraphs. They showed conclusively that the physiological qualities of seedlings (p. 102) can overbalance the effects of their morphological grades upon survival and growth.

The fact that physiological qualities differentiate *internal* seedling conditions must be emphasized. Physiological quality cannot be determined by ocular inspection. No means such as chemical testing of the foliage (787, 791) has yet been developed for recognizing various physiological qualities of southern pine nursery seedlings in advance of planting; the only way so far discovered for determining them is to plant the seedlings and observe their survival and growth. For these reasons, physiological quality

classes resembling the morphological grading rules in table 20 have not yet been formulated. Even when they shall have been, it is unlikely that they will be applicable to individual seedlings. They probably will have to be confined to determining the average physiological quality of large lots of stock, by a process of sampling, much as average germination percent is determined for large lots of seed.

These facts do not lessen in the least the importance of physiological quality. They merely make it more difficult than one would wish to use physiological quality classes as guides to nursery and planting practice. Recognition of the existence and importance of physiological quality has been generally helpful in correcting misconceptions concerning morphological grades and in learning the causes of high and low initial survivals. The fact that the physiological quality of specific lots of stock can be determined from behavior in the plantation has been of immense practical help in specific cases by showing which nursery treatments produce high quality stock.

The known facts and more important surmises concerning physiological qualities of southern pine nursery stock may be summarized as follows:

1. Physiological quality is not necessarily identical with capacity to survive and grow. For example, of two seedlings having equally high physiological quality, the larger might be better able to resist frost heaving or to compete with overtopping grass, and therefore have a higher capacity to survive. In the great majority of cases, however, physiological quality and the capacity to survive and grow probably are about the same for all practical purposes.

2. Morphological grades and physiological qualities may or may not coincide. It is thought that coincidence of morphological grade with physiological quality explains the many good survivals of seedlings of high morphological grade, and the many poor survivals of those of low morphological grade. Lack of such coincidence is believed to explain equally well many reported cases of poor survival of morphologically high-grade stock and of good survival of morphologically low-grade stock.

3. High physiological quality of southern pine seedlings seems to improve survival principally by insuring that the water intake of the seedlings immediately after planting equals or exceeds their water loss. The probability is great that in many cases it insures this favorable water balance by enabling the seedlings to extend new root tissue into the soil of the planting site within the first few days after planting. These two surmises are supported by the observed reactions of seedlings to drought and to freezing (pp. 123 and 148) ; by the behavior of many thousand variously treated and planted seedlings in survival studies (pp. 113 to 139) ; and by observations and measurements of new roots formed by seedlings during the first few weeks after planting. In particular, experimental

treatments that have most consistently reduced the physiological quality of longleaf and slash pine seedlings—without in any way affecting their morphological grade—have also interfered most seriously, and very significantly, with the prompt formation of new roots after planting. The importance of favorable water balance to initial survival, of new root growth to water balance, and of physiological condition of the stock to both, is too well substantiated by published studies of southern pines and other species to require elaboration here (35, 64, 115, 159, 218, 248, 366, 380, 384, 386, 388, 405, 438, 474, 480, 495, 563, 564, 606, 632, 633, 640, 649, 646, 647, 783, 787, 791, 793).

4. Mineral nutrition, which is governed largely by the natural fertility level or the fertilizer treatment of the nursery soil, may greatly affect the physiological quality of southern pine nursery stock. Although differences in climatic conditions may also play a part, differences in mineral nutrition probably are the principal causes of differences in survival among lots of stock produced in different nurseries but graded by the same morphological grading rules and planted at the same time on the same site. Records of a number of such matched plantings of stock from different nurseries show that seedlings from some nurseries tend to survive well and those from others to survive poorly, regardless of season or planting site, or even of species (table 21). Differences attributable to nursery source alone, and probably largely to differences in mineral nutrition, may make the difference between success and failure in the plantation. More recent studies have shown very significant differences in survival of morphologically similar southern pine seedlings, arising from the use of different inorganic fertilizers under controlled conditions in the same nursery. The references cited in the preceding paragraph also include examples of the effects of mineral nutrition on the

physiological condition and consequent survival¹ of southern pine and other seedlings.

5. Variations in stored food reserves seem to be another important source of variation in the physiological quality of southern pine seedlings. Stored food reserves may affect water intake and outgo directly, and may affect water intake indirectly through their effect on the development of new root tissue after planting. Even during a 5-week period in midwinter, accumulation of such food reserves may be both extensive and highly variable (table 18). Experimental interference with such accumulation of stored food reserves by shading seedlings heavily for 10 to 12 weeks before planting has reduced the survival of longleaf pine seedlings by 15 to 26 percent, and of slash pine seedlings by 56 to 79 percent, as compared with the survivals of unshaded checks. In one study the mortality of the shaded seedlings of both species was clearly associated with their failure to develop new roots as promptly after planting as did the unshaded seedlings. The importance of stored food reserves in connection with frost hardiness and other physiological conditions has also been shown in a number of studies of other species (64, 159, 380, 495, 563, 645).

6. The relative difficulty with which plants obtain an abundance of moisture from the soil is referred to as the "water tension" under which they are grown. Although the subject has not been investigated systematically in southern pine seedbeds, it seems probable that water tension, particularly toward the end of the nursery growing season, greatly affects the physiological quality of the seedlings. High water tension—that is, regular or periodic exposure to conditions approaching drought, but not extreme enough to cause injury—has, with several species of conifers and other plants, increased stored food reserves, increased drought resistance, and very greatly increased sur-

TABLE 21.—*Varied survival of graded' southern pine seedlings grown in different nurseries and planted on comparable sites within seasons*

Species; season and location in which planted	Survival of seedlings from nursery ²													
	A	B	C	D	E	F	G	H	I	J	K	L	M	N
Slash pine:	Per- cent	Per- cent	Per- cent	Per- cent	Per- cent	Per- cent	Per- cent	Per- cent	Per- cent	Per- cent	Per- cent	Per- cent	Per- cent	Per- cent
1936-37, Alabama							94		39					
1938-39, Mississippi	98	96		80			93		96	57	66			38
1939-40, Mississippi					76		58		54		50		58	
1939-40, Florida					66		24		38		36		27	
1939-40, Louisiana					92		86		77		74		70	
1940-41, Alabama						61	64	76	83			48		49
Longleaf pine:														
1936-37, Alabama			³ 85						20					
1940-41, Alabama						90	93	70	69			57		62

¹ All plantable according to table 20, except as noted.

² Nurseries arranged in descending order of average survival for all seasons and locations.

³ Mostly culls according to table 20.

vival after planting (161, 238, 248, 366, 480, 632, 633, 640, 647). Higher water tension in the equally well watered but more excessively drained soil of bed II may have been the main reason for the better survival of the bed II than of the bed I slash pine stock in the studies described on page 107. Presumably, also, it explains the effectiveness of withholding water in the fall and late summer to "harden off" the stock, as recommended on page 77.

7. The physiological qualities induced in southern pine nursery seedlings by mineral nutrition, etc., may be modified by the physiological effects of sprays applied at lifting time—favorably in the case of some sprays, unfavorably in the case of others (p. 132). Bordeaux mixture (both alone and with various stickers), stickers without bordeaux, and at least two rabbit repellents have produced significant variations in the survival of southern pines in this manner, entirely aside from the fungicidal or repellent effects of the sprays. Similar effects of sprays have been reported for other species of pine (479, 646).

Recommendations

The fact that various morphological grades and physiological qualities both occur within the same lot of stock, and the inconsistent results obtained from the first and the lack of definite knowledge about the second, makes it difficult to write specific recommendations for grading southern pine nursery seedlings. Nevertheless the following seem justified in the light of available information.

1. Regardless of morphological grades or physiological qualities, cull all seedlings infested with scale insects, infected with rust, or conspicuously infected with root rot, or with broken or conspicuously skinned stems, badly stripped, skinned, or split roots, total root lengths of less than 5 inches, or conspicuously stripped foliage. (This is culling based on sanitation and breakage rather than on grades, but there is strong evidence to support it, and it sets the stage, so to speak, for grading.) Individual longleaf seedlings with 35 percent or more of their total leaf area in brown-spot lesions or dead tips should be culled also when found. Seedlings should not be culled solely because of infestation by Nantucket tip moth, except to safeguard uninfested planting sites.

2. Where seedling densities have not been well controlled, and exceed 60 living seedlings per square foot in considerable patches or throughout the beds, use the morphological grading rules of table 20. With seedlings grown in overdense or irregular stands, these rules effectively eliminate seedlings too small and weak to plant easily, and in the larger-sized seedlings appear to differentiate capacities to survive and grow.

3. Where seedling densities are uniformly below 60 living seedlings per square foot, and especially where soil management has been fairly good and

stock from the same nursery has previously survived well on ordinary sites, two courses of action are open.

- a. When the producer of the stock is planting it on his own land, the grading rules of table 20 may be disregarded and bed-run seedlings may be planted, except for culls—the infested, infected, and mechanically injured seedlings and seedlings too small to plant conveniently. (Seedlings less than 3 inches high are definitely too small for easy commercial planting.) If desired, such bed-run stock may be planted at slightly closer spacing than usual, to offset slightly higher mortality.
- b. When the stock from such beds is being sold, some grading in addition to culling usually is necessary to insure justice to the buyer, and to avoid disputes. (There may be an exception when stock from the nursery in question has demonstrated beyond any doubt the ability to survive exceptionally well regardless of size.) Grading of stock to be sold may take the specifications on page 102 and table 20 as a starting point. Unless experience has shown physiological quality to be low, however, these grades may be relaxed somewhat. Seedlings without secondary needles but above the minimum size limits, and seedlings slightly below the minimum size limits but with good secondary needles, may be shipped as plantable. From December 1 through February 15, evidences of nondormancy of tops may be disregarded. Such modifications of the grading rules should be made clear to the purchaser, however, and should be supported to the extent possible by plantation performance records of borderline classes.

4. Stock for especially severe sites or for particularly exacting customers should be supplied, so far as possible, from beds or compartments known from past experience to produce seedlings of high physiological quality. If there is no information concerning physiological quality from different parts of the nursery, remember that morphological culls (grade 3, table 20), the largest morphological grades (grade 1, table 20), and seedlings with obviously nondormant tops have all, on one occasion or another, survived less well than apparently top-dormant seedlings of intermediate "plantable" size (grade 2, table 20) from the same beds; and grade accordingly.

5. As far as possible, test and confirm the effects of changes in nursery practice upon physiological quality, by planting and reexamining representative samples of stock grown under both old and new practices. Testing of physiological quality, even by such a slow method, is a far sounder guide to nursery practice than is the recording of changes in morphological grade following changes in treatment.

NURSERY SOIL MANAGEMENT

Good nursery soil management is an essential step in growing the southern pines for planting. It justifies considerable expenditure. Southern pine seedlings are an outstandingly valuable crop, regularly worth at least \$3,000 to \$5,000 per nursery acre to produce.³⁷ One must expect to apply an appreciable percentage of these amounts to soil fertility maintenance, or see the quality of the stock go down.

Though there is an immense amount of complex information on soils and soil management, its adaptation to nursery soil management has barely begun. Research on southern pine nursery soils has been fragmentary, largely empirical, and too seldom followed through into the plantation. Soil differences from nursery to nursery frequently make findings in one place inapplicable in another; Auten (60) has reported a striking example. All that can be done here is to call attention to the more important southern nursery soil management problems recognized to date, and give some general rules and specific suggestions for dealing with them. The individual nurseryman should be quick to challenge either rules or suggestions in the light of clear contrary evidence from his own nursery.

Seedling Requirements

Adequate mineral nutrients alone will not insure good nursery seedlings. Good physical structure and condition of the soil are essential to optimum germination, emergence, root development, and seedling moisture relations (51, 60, 408, 533). They are also essential to good erosion control and drainage, and to maximum ease, flexibility, and economy of bed making and particularly of lifting. Not only disease and low nutrient levels but also poor physical condition of the soil should be suspected and investigated whenever stock fails to develop uniformly and well.

Although pines, and particularly the principal southern pines, are among the least exacting of forest trees in their requirements for mineral nutrients (437, 569, 746, 783), they must have relatively large amounts of nitrogen, phosphorus, potassium, and calcium, smaller amounts of sulfur and iron, and traces of magnesium, boron, copper, manganese, zinc, and other elements. For southern pine nursery seedlings to attain high physiological quality, these elements apparently must be available in nearly optimum proportions one to another; Wilde and coworkers have similarly emphasized the need for optimum nutrient levels

³⁷ The approximate average prices received per acre from some other southern crops in 1947 were: Louisiana sugarcane, \$113; Louisiana cotton, \$118; Louisiana strawberries, \$376; North Carolina tobacco, \$481; Kentucky tobacco, \$505 (734).

by nursery stock of northern species (793). Moreover, the great number of southern pine seedlings produced per acre (usually about 1 million) makes the total nutrient requirement *per acre of nursery soil* fairly high.

Moderate acidity (pH 6.0 to 5.0) seems about optimum for southern pine nursery soils, although acceptable results have been obtained on soils as strongly acid as pH 4.5. Soil acidity or alkalinity is expressed in terms of the pH, or hydrogen ion concentration, according to a numerical scale in which 7.0 represents neutrality (neither acid nor alkaline), and 3.0 represents about the extreme acidity tolerated by southern pine trees. A pH of 8.0 represents moderate alkalinity, ordinarily not favorable to southern pines and apparently quite injurious to young southern pine seedlings. Levels of soil acidity differing little in their direct effects on pine seedlings may, however, differ greatly in their effects on the availability of one or another nutrient element the seedlings must get from the soil (p. 113), and on damping-off (pp. 89-91).

Effects of Cropping System on Soil

The prevailing system of producing southern pine nursery stock was developed primarily for economical sowing of the seed and watering, weeding, and lifting of the seedlings. It is hard on most soils in the southern pine types.

Suitable location and the requirements of seedlings for drainage, soil texture, and hydrogen ion concentration (p. 70) often limit choice of nursery site to soils structurally subject to severe erosion and low in mineral nutrients—particularly nitrogen and phosphorus (52, 437, 493, 593)—and sometimes to soils so acid as to make essential mineral nutrients relatively unavailable to the plants (60, 153, 593). Organic matter usually is low, and, under prevailing nursery practices, is likely to be reduced (60, 662, 709). The coarser soils may retain moisture poorly or lack desirable cation-exchange capacity.

On many sites, the deep plowing required for good root development and the deep undercutting unavoidable in mechanical lifting dilute the surface soil with poorer subsoil. Terracing to control erosion and grading to improve drainage are likely to increase such damage.

Unavoidable foot and machine traffic packs the soil injuriously. Often, especially during lifting, the soil must be worked when it is undesirably wet. The nursery schedule almost invariably exposes the soil to packing by rain and to erosion by both rain and wind for considerable periods each year, and to full sunlight at times when high temperatures accelerate loss of desirable organic matter through oxidation. The open winters, heavy rainfall, and hot summers characteristic of most southern pine nurseries intensify injuries to the soil from these various causes.

Typical crops of southern pine nursery stock, like those of northern nursery stock (783), take more mineral nutrients out of the soil than do field crops—perhaps four to six times as much as cotton or corn. The heavy drain results partly from the sheer mass of plant tissue produced by the closely spaced seedlings, and partly from their exceptionally complete removal from the soil. The copious artificial watering required by southern pine seedlings may leach additional percentages of nutrients out of some nursery soils.

Supplying nutrients in the form of inorganic ("commercial") fertilizers often reduces soil organic matter and injures soil structure. Wrong choice of fertilizer may affect soil acidity adversely.

In short, unless their effects on the soil are taken into account, the techniques used in growing nursery stock may make the soil progressively less capable of producing it.

Keeping the Soil in Good Physical Condition

Achieving and maintaining good physical condition of the soil usually requires systematic efforts to increase organic matter content (pp. 115 and 116); to protect the soil surface as continuously as possible with mulches (p. 76), cover crops (p. 116), or seedling stands (p. 77); to minimize movement of water over the surface; to avoid exposure of subsoil and intermingling of subsoil with surface soil; and to avoid packing the soil or working it when it is very wet.

Increasing the organic matter content, in addition to directly improving soil structure, increases its water-absorptive capacity. Combined with protection of the soil surface, it does much to decrease erosion by surface water. Where rainfall is heavy, however, and slopes exceed 2 or 3 percent, terracing usually is necessary to control sheet erosion, even though the terraces expose some subsoil or mix it with surface soil.

Soil cropping, bedmaking, and lifting should be done with the minimum possible amount of driving or walking on the beds. Although moderate firming of seedbed soil by rolling (p. 72) seems harmless or even beneficial, heavier packing is injurious to most soils (662). In some southern pine nursery beds, corners repeatedly cut across by trucks at lifting time, and also ruts of dirt roads that crossed the site before the beds were first established, have remained unproductive even after years of subsequent cultivation and fertilization. Foot traffic and heavy machinery inevitably pack the soil severely in nursery paths. Where beds have been moved, the portions of them falling on former paths usually show poor growth and heavy mortality. The movement of soil from paths into beds by plowing and harrowing between seedling crops may account for some otherwise unexplained fail spots in later seedling stands.

Plowing, disking, or undercutting any but the most sandy soils when they are very wet is likely to injure their structure. Some undercutting of wet soils is unavoidable, but should be kept to a minimum, and the harm done should be reduced by maintaining soil organic content at the highest possible level.

Fertilizing and Amending Nursery Soils

Effective fertilization or amendment involves finding out what the soil lacks and learning how to supply it without injury to soil or seedlings. Choice of treatment requires fairly accurate judgment concerning the physical condition, nutrient level, pH concentration, and organic matter content of the soil, and knowledge of how these are likely to be affected by different treatments. An amount of an inorganic fertilizer effective on one soil, for example, may be inadequate on a second soil, and highly injurious to seedlings on a third. Green manure crops may improve organic content primarily, or modify it and nutrient levels about equally. Most soil amendments are applied to improve organic content, but some may seriously upset nutrient balance unless inorganic fertilizers are applied with them. Time, amount, and method of application must often be chosen as carefully as kind of treatment, to avoid waste of material or injury to seedlings.

Poor water absorption, poor water retention, poor moisture-supplying capacity, high erodibility, and a tendency to form a surface crust or bake hard when dry are signs of poor physical condition. They are observable in the soil itself or in the stunted growth, poor root development, and sometimes in the wilting, of the seedlings. Poor physical condition is likely to be associated with percentages of fine particles less than 15 or more than 25 by weight (p. 70) and with soil organic matter below 1.0 percent, and may often be corrected by increasing organic matter to 1.5 or 2.0 percent.

Hydrogen ion concentration can be measured closely enough for all practical purposes by means of inexpensive test kits (780). In general, soils less acid than 6.0 may require fertilizers having an acidifying effect, while in those more acid than 5.0 much of the phosphorus already present or added as fertilizer will be unavailable to seedlings unless acidity is reduced (p. 114).

Fairly accurate direct measurements of organic matter content may be made by the ignition test or other techniques (783). Ignition-test readings will be high if the soil contains charcoal. Soil organic matter content determinations usually can be made most easily by the State agricultural experiment station.

Foliar analyses, which have proved useful guides to the fertilization of fruit and other crops (723), have not yet been adapted specifically to southern pine nursery stock, and chemical analyses of the soil usually are difficult to translate into

exact guides to nursery fertilization. The State agricultural experiment station may nevertheless be able to tell, from adequate random samples, whether the nutrient elements in the nursery soil are sufficient for agricultural crops, or dangerously low. Moderate to large quantities of the various elements should be added accordingly to allow for the somewhat greater demand of pine seedlings than of ordinary agricultural crops (p. 112) .

When soils analyses are not available it is generally safe to assume that nitrogen and phosphorus are most likely to be deficient, and potassium next most likely. As a rule, southern pine nursery soils contain ample calcium, sulfur, iron, and trace elements, and the calcium and sulfur already present are augmented whenever phosphorus is applied in the form of superphosphate. The necessity of applying lime before sowing pine, either to supply calcium or for other purposes, seems never to have been demonstrated in any southern nursery, and liming may seriously increase damping-off (pp. S9-91).

The appearance of the seedlings themselves gives many clues to desirable fertilizer treatments (186, 783). Chlorosis (p. 94) may indicate over-closes of readily soluble inorganic fertilizers, lack of iron (remedied by foliage sprays) , or nitrogen deficiency. Stunting and yellowing often indicate nitrogen deficiency. Irregular growth, poor root development, and purpling before cold weather are likely to mean phosphorus deficiency (p. 83) . Sudden death of very young seedlings as the soil dries but before drought conditions develop, or dying and browning of needle tips, or visible chemical injury to roots, occurring on fertilized beds when stock remains healthy on unfertilized beds, usually means fertilizer has been applied in excess or in too easily soluble form. Eliason has published an ingenious method of testing the relative nitrogen deficiency on variously fertilized or cropped seedbed areas by sowing buckwheat, which is a sensitive indicator of nitrogen shortage (240).

Pending the development of the best fertilization or soil amendment for particular nurseries, overtreatment can be avoided by making moderate applications, perhaps short of optimum, but large enough to do some good. It is easier to add more nutrients later than to correct an initial overdose (783).

Locally effective soil management practices can be learned most rapidly and reliably by laying out a series of small test plots each year in representative parts of the nursery to try, in advance of general application, the fertilizers and soil amendments which appear to be desirable. Tests will be most valuable if each treatment is tried in at least two separate plots to see whether it gives consistent results ; if detailed records of treatments (including dates and rates) and results (survival, growth, damping-off, weed development, and pH concentration) are kept ; and if treated seedlings and untreated checks are outplanted and reexam-

ined in the field. Small plots may also be sown before the main crop in the spring to see whether proposed fertilizer treatments cause excessive emergence failures, damping-off, or root injury or foliage "burning" of very young seedlings. In evaluating such advance sowings, however, the possible effects of season of sowing on damping-off must be allowed for (p. 90) and outplanting may be omitted.

Inorganic Fertilizers

The simplest means of adding known amounts of mineral nutrients to nursery soils, and often the only economical way of correcting serious nutrient deficiencies, is by applying inorganic fertilizers. Examples of their negative or harmful effects and sweeping recommendations against their use (60, 153, 223, 438, 718, 750) must be discounted somewhat because of the important need such fertilizers fill in nursery soil management. Such failures as occur probably are attributable not to the fact that the fertilizers are inorganic, but to incorrect application for the particular seedling species, seedling age, rainfall, watering, soil fertility level, soil texture, cation-exchange capacity, or soil acidity involved.

The mineral nutrient requirements *and tolerances* of southern pine seedlings, like those of other conifer seedlings, differ at different ages. Very young shortleaf pine seedlings are more sensitive to excess calcium than are older trees (160) . Nutrient concentrations optimum at midsummer or near lifting time may be injuriously high for seedlings in the cotyledon stage (644). These variations in requirements with age may make it desirable, in fertilizing before sowing, to use the less soluble rather than the more easily soluble fertilizers. The "carrier," or chemical compound, in which a nutrient is applied may also affect the extent of injury to seedlings (661, 783).

The amounts of the various nutrient elements that must be added to the soil to meet the requirements of specific seedlings may vary enormously from nursery to nursery, soil to soil, and year to year. They depend not only on the apparent shortages of the necessary elements as shown by soil analyses, but also on soil texture, leaching, chemical reactions within the soil, and potential drain by seedlings and other plants.

Soils high in silt and clay require larger applications of a given element to produce a given result than do soils low in these components (781) .

Some of any element added as fertilizer may leach out before the plants can use it. Nutrient elements vary in the rate at which they leach out of a given soil ; potassium (380, 786) and nitrate nitrogen are particularly subject to leaching. Any one element may vary in rate of leaching, depending on the carrier in which it is applied (789). Even with the same carrier, rate of leaching may increase with increases in rainfall, artificial watering, and coarseness of soil texture.

There may be serious losses of nitrogen compounds, potassium, and replaceable bases when sulfuric acid is applied to soil to control damping-off (782). Whenever leaching appears likely, fertilizer applications should be timed to minimize it or increased to allow for it.

Allowance may also have to be made for the unavailability of nutrient elements because of chemical reaction in the soil (380, 644, 786). Phosphorus, for example, becomes increasingly less available as soil acidity increases (60, 593), especially below a pH concentration of about 5.8 (153), and the availability of nutrients in general is low in soils more acid than pH 4.5 (780). Potassium and the nitrate of sodium nitrate are readily available in highly acid soils (pH 4.5 to 4.0), but potassium becomes rapidly less available as soil reaction approaches neutrality; and ammonia nitrogen is most highly available at pH 6.5 to 6.0 (153).

Unlike green manure crops and most organic fertilizers and soil amendments, some inorganic fertilizers tend quite definitely to increase or decrease the acidity of the soil. Inorganic fertilizers therefore must be chosen to avoid undesirable effects on soil acidity, and may be used to make the level of acidity more favorable to mineral nutrition, damping-off control, or the seedlings themselves. The direction of change caused by a fertilizer depends upon the specific, individual carrier, not upon the nutrient element carried. Even slight changes arising from single treatments tend to be cumulative with successive treatments. Chadwick lists sulfur, aluminum sulfate, ferrous sulfate, ammonium sulfate, and ammonium nitrate as carriers increasing soil acidity. Hydrated lime, ground limestone, basic slag, dolomitic limestone, calcium cyanamide, calcium nitrate, and sodium nitrate, on the contrary, decrease acidity. Potassium nitrate decreases soil acidity slightly. Superphosphate, calcium sulfate (gypsum), magnesium sulfate, muriate of potash (potassium chloride), and potassium sulfate cause little change in soil acidity (153). The tendencies of many other fertilizers, especially inorganics, to increase or decrease acidity, are well known, and can be obtained from soils texts (186, 783), State agricultural experiment stations, or fertilizer manufacturers or dealers.

Through its effect on size of seedlings, the amount of one nutrient element present in the soil or added as fertilizer may increase the need for another nutrient element (223). For example, what may be sufficient phosphorus for seedlings growing to moderate size in the presence of a moderate supply of nitrogen may be wholly inadequate for seedlings growing to larger size as a result of adding more nitrogen. The microorganisms that decompose organic matter in the soil also utilize mineral nutrients, especially nitrogen, that the soil contains, and may do so at the expense of the seedlings if the organisms are very abundant and extra nutrients are not supplied in fertilizers.

Once the desired additions of nutrient elements have been learned from test plots or estimated from soils analyses, comparison with field crop requirements, or the results of past treatments, and have been adjusted to allow for leaching, soil acidity, and the like, the amounts of inorganic fertilizer substances needed to supply them may be calculated. A "complete" commercial fertilizer with a "6-10-7" analysis, for example, contains 6 parts by weight of available nitrogen (as elemental nitrogen, N), 10 parts of phosphorus (as citrate-soluble phosphoric acid, P₂O₅), and 7 parts of water-soluble potassium (as potash, K₂O), plus enough combined elements and inert ingredients to bring the total up to 100 parts by weight (186). Tables are available (777) showing the percentages of nitrogen, phosphoric acid, and potash in the commonly obtainable inorganic fertilizer materials, and the amounts of the various materials required to provide specific quantities of nitrogen, phosphorus, and potassium. These tables are a great convenience both in calculating rates of application and in finding the cheapest carriers of the nutrient elements at current prices.

Where difficulties are experienced with injuries to young seedlings from excessive concentrations of nitrogen or potassium, or with serious leaching of these nutrients before the seedlings can use them, part or all of the fertilizer can be applied at intervals during the growing season instead of before sowing. Although excessive late-season fertilization, especially with nitrogen, seems likely to force growth just before lifting and to reduce plantation survival, light periodic applications, including late-season applications of potassium, hold much promise and deserve thorough testing. (Phosphorus applied as superphosphate is much less likely to injure seedlings or to leach out than are nitrogen and potassium, and is much less effectively applied as a top dressing; the total amount of phosphorus required should therefore be applied before sowing, though perhaps better in granulated than in powdered form.) Relatively insoluble carriers of nitrogen and potassium may be another means of reducing injuries or leaching.

Drill-sown seedlings can be side-dressed mechanically with dry fertilizers until too large to let the fertilizer tubes pass between the drills. *Provided the fertilizer solution is washed off the foliage and into the soil immediately afterwards by means of overhead sprinklers, to prevent burning of the foliage*, both drill-sown and broadcast-sown seedlings at any stage of development can be fertilized at suitable rates with any of the common water-soluble carriers of nitrogen or potassium, or with phosphorus carriers in suspension, by dissolving or suspending the fertilizers in water and applying them to the beds with a low-pressure spray rig. Fertilizers applied in either of these two ways (42, 51, 60, 114, 302, 380, 783, 789, 793) when the stock is fairly well grown may meet its nutrient requirements at their peak, with minimum

harm to the seedlings and with much smaller losses by leaching than occur when fertilizer is applied before sowing.

Green Manure, Cover, and Catch Crops

Green manure or soiling crops are grown to add nutrients and organic matter to the soil. They are not harvested, but are plowed or disked into the soil on which they have grown. They necessitate increasing the seedbed area of southern pine nurseries by at least 50 and usually by 100 percent, so that part can be in green manure crops while the rest is producing pines.

Cover crops are grown to protect the soil from erosion and sometimes from the sun, and to choke out weeds.

Catch crops are grown to utilize, hold, and return to the soil the nutrients added currently or already in it, lest they leach out or otherwise become unavailable to seedlings grown later on.

Although most green manure crops are grown during the summer, and many cover and catch crops over winter, one crop may serve simultaneously as catch crop, cover crop, and green manure.

In the early and middle thirties many nurserymen began growing green manure crops, usually legumes, in attempts to build up obviously depleted or deteriorating southern pine seedbeds. Similar practices had already become fairly common in forest nurseries in the Northeast (682).

In the South it was soon discovered that satisfactorily heavy green manure crops could be produced only if the plants were fertilized, and that commercial fertilizers usually could be introduced into the soil through the green manure crop with fewer undesirable effects on southern pine seedlings grown the following year than if they were applied immediately before sowing the pines. Both these findings are consistent with results obtained with other species of seedlings and in other regions (115, 151, 502, 662).

Legumes have generally been preferred for green manure, cover, and catch crops in southern pine nurseries, because they add much-needed nitrogen to the soil; their effect on the carbon-nitrogen ratio (709), however, requires further study. Clay, Whippoorwill, and other short-lived varieties of peas have generally been grown as two crops, sown in April or very early May and in late July or in August, and turned under in July and October, respectively, or sown in May after spring vetch, and turned under in September. Many nurserymen have found a single crop of velvet beans or soy beans, sown in April or May and turned under in late August or in September, preferable to double crops of peas for summer green manure crops. *Crotalaria spectabilis* and *Sesbania macrocarpa* have, in general, been less satisfactory than peas or beans for summer green manure crops, though *Sesbania* has the advantage of germinating better than most green manure plants on dry sites.

For winter or spring cover and catch crops several different vetches, Austrian winter peas, Italian rye, oats, and mixtures of oats and vetch have proved well adapted under one or another set of circumstances, and winter vetch and varieties of lespedeza have been used as cover crops in paths in winter and spring.

Choice of green manure, cover, and catch crops in any locality should be guided by local practices; the advice of the county agricultural agent, the Soil Conservation Service, and the State agricultural experiment station; the considerable literature on the subject (37, 120, 414, 453, 454, 767, and later State and Federal publications); and small-scale tests in advance of general use. The following general precautions are necessary in choosing and growing such crops:

Some green manure crop plants, or certain varieties of them, are susceptible to nematodes, while others are fairly resistant. When there is any suspicion of a nematode problem, green manure crops should be selected in the light of the most recent information obtainable from the State agricultural experiment station and the U. S. Bureau of Plant Industry, Soils, and Agricultural Engineering, Washington, D. C., concerning nematodes and host plants.

Legume green manure crops may develop poorly, or fail, unless inoculated with nodule-forming bacteria. The State agricultural experiment station or the local county agricultural agent is usually the best source of information on inoculation.

To function effectively as cover crops for keeping down weeds, plants sown in rows at wide spacing (such as cowpeas, velvet beans, and soybeans) usually have to be cultivated until the plants in adjacent rows have grown almost together. Otherwise weeds will come up and go to seed between the rows, to the detriment of pine seedlings the following year.

Winter cover or catch crops, or green manure crops sown early in the spring, may attract egg-laying adults of cutworms, and give rise to outbreaks of these destructive insects. Seedbeds near such crops, and the crops themselves, should be inspected daily, and poison bait should be spread upon the slightest indication of a rapid increase in cutworm population (p. 85).

Sowing pine too soon after turning in a green manure or similar crop may result in severe damping-off (especially if the green manure is a legume), nitrogen-starvation (especially if the green manure is a nonlegume (574, 575)), or other injury. Davis and coworkers recommend turning under such crops at least 1 month before sowing pine (223). This period may perhaps be shortened by a few days in the case of very light winter cover or catch crops, such as Austrian winter peas, or even oats, turned under when spring temperatures have become high enough for quick decomposition. Extreme caution is advisable, however,

and as a rule the period should be lengthened rather than shortened.

Turning under a green manure crop, such as velvet beans, in the fall, especially if no winter cover or catch crop is grown, may result in avoidable erosion and also in leaching of much of the nutrient material in the green manure crop. There is some evidence that it is better to leave the cover crop on the surface of the ground all winter and to turn it under in the spring (453, 710) just long enough before sowing to avoid risk of injuring the pine seedlings. Such deferred turning under has worked well in a few nurseries and deserves thorough trial under various local conditions.

Composts, Organic Supplements, and Other Soil Amendments

Abundant soil organic matter is credited with lightening and loosening heavy soils, decreasing crusting and erosion, increasing moisture-absorptive and moisture-retentive capacity (especially of light soils), increasing cation-exchange capacity, reducing loss of nutrients by leaching, preventing injury to young plants by high concentrations of nutrients, and reduction of *Sclerotium bataticola* (p. 93) (60, 97, 115, 662, 709, 783, 792). So enthusiastically is soil organic matter regarded by many that there is danger of its being expected to cure ills with which it has no connection—poorly stored seed for example. Undeniably, however, heavy applications of organic matter have conspicuously improved many southern nursery soils.

In some instances green manure crops have produced the improvement attributed to increased organic matter. In one nursery, a sheet-eroded knoll incapable of producing pine seedlings was made highly productive by growing and plowing under two crops of cowpeas a year for 2 years. Such cases are exceptional, however. In general, turning under the best of green manure crops in alternate years, without applying additional organic remains from other sources, seems likely to do little more than maintain soil organic matter at the existing level (115, 331, 502, 533, 662, 709, 783). Auteh questions whether green manure crops can do even this (60).

Increases in organic matter great enough to put the nursery soil in optimum condition may therefore depend in many cases upon the addition of vegetable remains produced elsewhere than on the seedbed area. This is true particularly of localized "galled spots." In southern pine nurseries some form of compost has been widely and successfully used for such additions.

Compost consists of organic remains allowed to decompose in piles or pits, alone or in mixture with soil, inorganic fertilizers, or both. Many different substances have been used fairly successfully for compost—stable or barnyard manure, stable litter, weeds, grain straw, woods leaf litter, to-

bacco waste, pulpmill waste (Masonite process), bagasse, and sawdust. Moss peat, recommended by many authors, ordinarily is not available in the South at reasonable cost. Pine cones, though available from seed extracting plants at many nurseries, are not recommended, as they seem to decompose too slowly even when shredded.

Muntz increased the producing capacity of a heavy nursery soil by 25 to 50 percent or more (measured in terms of numbers of seedlings per square foot and percentages attaining "plantable-grade"), by applying 1 inch of rice straw compost, or 23 tons per acre, dry weight (533).

This heavy and expensive application of compost has been found, in practice, to be excessive. Region 8 of the U. S. Forest Service has made much lighter applications of the same compost (estimated at one-eighth, one-quarter, and one-half inch, or 3, 6, and 12 tons dry weight per acre), sometimes directly before sowing pine, sometimes only before sowing the green manure crop grown in alternate years. Both methods of application have been distinctly beneficial. Several State nurseries have found similar treatments satisfactory. Applications in excess of 1 inch reduced germination, increased mortality of very young seedlings, and distorted the roots of older seedlings by leaving too much irregularly distributed compost near the surface (533). In the larger scale, lighter applications such troubles have been rare, though there have been some chlorotic patches when the compost has been applied immediately before sowing the pine. Legumes, such as velvet beans, seem to suffer less injury than pine seedlings from imperfectly decomposed compost or from irregular distribution of the compost in the soil.

The process of preparing the rice straw compost used by Muntz and Region 8, with other pertinent data and comments, is given on page 225. The chief obstacle to using compost in southern pine nurseries has been the difficulty of getting raw material at sufficiently low cost, but some compost can be made at almost any nursery for use on small areas of the least productive soil, such as sheet-eroded spots, or patches of coarse sand or heavy clay.

Frequently it is suggested that either organic amendments other than composts, or inorganic amendments, be used to lighten heavy soils or to increase the fertilizer- and moisture-holding capacities of coarse sands. Substances recommended or tried have been clay (on sands), topsoil (on clay), sand (on clay), and (on a great variety of soils) charcoal, moss peat, bagasse, chopped grain straw, chopped pine needles, hardwood leaf litter, stable or barnyard manure, tobacco waste, pulpmill waste (Masonite process), and sawdust (51, 60, 341, 408, 722). Results have been highly variable and some of the suggested treatments would be impracticable on any large scale.

Good topsoil has improved both sands and clays in some instances, and sandy topsoils have improved clays, but their use is seldom feasible over

large areas. Very finely divided charcoal may be physically beneficial to excessively heavy and to very light soils in some circumstances, but this has not been demonstrated in southern nurseries. Applications of undecomposed organic matter without accompanying inorganic fertilizers have frequently done more harm than good. In one direct comparison, chopped rice straw, chopped pine needles, granulated moss peat, bagasse, hardwood sawdust, fine hardwood charcoal, and fine quartz sand, applied without fertilizer and worked into the soil before sowing, all affected the four principal southern pines adversely as compared to untreated checks or to additions of compost or of virgin topsoil. With the exception of sawdust, the materials mentioned offer little promise in southern pine nurseries.

Sawdust, however, *applied with suitable amounts of fertilizers*, appears to be an excellent means of building up desirable quantities of organic matter in southern pine nursery soils without injuring the seedlings. It appears to leave no toxic residues, although it may sometimes alter soil acidity. It is easy to measure, apply, and work into the soil. It is almost universally available at little cost. So far as is now known, either pine or hardwood and either fresh or weathered sawdust may be used. It has given good results with a variety of crops, and has worked well with southern pine seedlings both when applied shortly before sowing the pines and when applied before sowing the preceding green manure crop (13, 275, 444, 452, 550, 724, 740).

Sawdust contains very little of the three principal mineral nutrients—perhaps only 4 pounds of nitrogen, 2 pounds of phosphorus (as $1\frac{1}{2}O_2$), and 4 pounds of potassium (as K_2O) per ton, air-dry (724). Most of the total weight of sawdust consists of lignin, which decomposes slowly under almost any condition and is therefore capable of adding long-lasting, finely divided organic matter to the soil, and of cellulose, which decomposes very quickly when attacked by micro-organisms under certain conditions and furnishes abundant energy for their growth.

In a pile, sawdust decomposes slowly, because decay fungi, although they have an abundant source of energy, lack mineral nutrients. When sawdust is spread on or mixed with the soil, it decomposes much more rapidly because the decay organisms can get from the soil the mineral nutrients they need. They get them, however, at the expense of the pine seedlings or other plants growing in the soil. These become stunted or die for lack of the nutrients tied up in the bodies of the micro-organisms. The nitrogen needed by the seedlings is especially likely to be reduced below safe levels in this way. When the sawdust has been completely decomposed, most of the micro-organisms die for lack of food, and the mineral nutrients they contain again become available to the seedlings. The soil is likely to be greatly improved physically by the decomposition process

and the finely divided organic matter from the dead micro-organisms, and by the gradual breaking down of the lignin in the sawdust. The whole process is like that described by Pinck and co-workers and by others for straw (520, 574, 575).

Nitrogen may be applied with the sawdust in almost any form—inorganic nitrogen fertilizers, dried blood, or stable manure. The exact quantities of nitrogen and of other mineral nutrients that must be added undoubtedly vary with local circumstances, especially current soil fertility level. Turk recommends adding elemental nitrogen equivalent to 2 percent of the air-dry weight of the sawdust, or about 225 pounds of sodium nitrate or 180 pounds of ammonium sulfate per ton (721). Pinck and coworkers recommend adding 1.2 to 1.6 percent of nitrogen to wheat straw (574), the chemical composition of which somewhat resembles that of sawdust.

General recommendations cannot yet be made for rates of fertilization in connection with sawdust applications in nurseries, but the following treatments with pine sawdust have given excellent results (including high plantation survival) in one southern pine nursery and promising results in several others:

When used before sowing pine, sawdust is applied at the rate of 15 tons (air-dry weight) per acre (this is approximately three-fourths of an inch deep) after applying 2,000 pounds of 20 percent superphosphate (400 pounds of P_2O_5) and 400 pounds of 50 percent muriate of potash (200 pounds of K_2O) per acre. The sawdust and fertilizers are plowed or disked into the soil together, to a depth of about 6 inches but not more than 8 inches. Beds are made up and pine seed sown in the usual manner. Beginning about June 1, or a little before if sowing has been early or seedlings begin to yellow for lack of nitrogen, 4 applications of ammonium nitrate, each of 120 pounds (40 pounds of nitrogen) per acre, are made at about 1-month intervals. These top dressings may be applied dry or in solution, but if they are applied in liquid form the beds must be sprinkled *immediately* and *thoroughly* to wash the fertilizer solution off the foliage and prevent burning. If continuous production of pine without intervening green manure crops is desired, the same quantities of phosphorus, potassium, and nitrogen, but with only 10 tons of sawdust per acre (about one-half inch deep) are suggested for the second and later years.

When production of pine is postponed until the second year after sawdust is put on, and a green manure crop is grown the first year, sawdust, 20-percent superphosphate, and 50-percent muriate of potash are applied as in the preceding paragraph, together with 600 pounds of ammonium nitrate (200 pounds of nitrogen) per acre. All are plowed or disked in together to a depth of about 6 but not more than 8 inches, and the green manure crop is sown in the usual manner. At the correct stage of development the green manure crop is

turned under, to be followed by fall-sown longleaf pine or by a winter cover crop preceding spring-sown pine of any species. For subsequent alternate-year green manure crops, equal amounts of inorganic fertilizers but only 10 tons of sawdust per acre are suggested. The heavy fertilization of the green manure crops should make direct fertilization of the pine seedling crops unnecessary, but if the pine seedlings yellow for lack of nitrogen, one or more nitrogen topdressings are added as needed, at a rate not exceeding that in the preceding paragraph.

In the foregoing treatments, carriers other than those listed may be used to add equal amounts of phosphorus, potassium, and especially nitrogen (777). For the same amount of sawdust, however, different soils may require more or less of any of the three nutrient elements than is specified here. The best way of learning the correct combination for any soil is by means of small test plots (p. 27) treated with one-half to three-fourths inch of sawdust and with fertilizers at the rates specified here and at somewhat lower and higher rates.

Mycorrhizae and Soil Management

Under a wide variety of conditions, mycorrhizae are helpful or essential to good mineral nutrition of southern pines. In particular, instances have occurred in which southern pines have languished or died until accidental or deliberate inoculation of the soil with suitable fungi has led to the formation of mycorrhizae, whereupon nutrition and subsequent growth of the pines has greatly improved. (60, 223, 231, 307, 308, 309, 400, 441, 442, 500, 584, 808, 809.)

Mycorrhizae occur spontaneously all over most southern pine nurseries, and usually most luxuriantly on the best stock. Under such conditions, artificial inoculation of the soil with fungi is uncalled for. If, however, southern pine seedlings develop poorly in nurseries on land long in field crops, or never in pine, or beyond the borders of the southern pine region, the roots should be examined for mycorrhizae. If mycorrhizae are lacking, inoculation should be tried, using soil from beds where mycorrhizae have already begun to develop, or from thrifty pine stands nearby, or possibly using pure cultures of mycorrhizal fungi if suitable soil cannot be obtained in the vicinity.

Immediate Recommendations

1. Erosion should be controlled. Mechanical packing, working of heavy soils when very wet, mixing of heavy subsoil into surface soil, excessive watering, and other procedures which may injure the soil physically should be avoided or reduced, in every possible way.

2. Soil organic matter should be built up to and maintained at a 1.5 to 2.0 percent level by the use of green manure crops, composts, or organic soil amendments. Soils very low in organic matter

may require annual or alternate-year applications of 10, 20, or even 40 tons of compost or organic supplements per acre.

3. Fertilizers and other substances added to the soil preferably should be chosen to produce and maintain a pH concentration of slightly above 5.0, but not above 6.0.

4. Unless they result in succulent or oversize stock incapable of good plantation survival, additions of nutrient elements to the nursery soil should at least equal and possibly greatly exceed the average annual quantities required locally for agricultural crops. Phosphorus and nitrogen are especially likely to be required.

5. Any nutrient element added in inorganic form before sowing pines should be applied cautiously, in small to moderate quantities; periodic additions during the growing season, or moderate to heavy applications to the green manure crops instead of to seedlings, may be desirable supplements or alternatives.

6. Applications of lime should be avoided unless there is definite evidence of need for them, and then, for choice, they should be made before green manure crops rather than before pines. Large applications of easily soluble inorganic nitrogen carriers, such as sodium nitrate, or of easily decomposed organic nitrogen carriers, such as cottonseed meal or dried blood, should not be made when or just before sowing pines, and probably should not be made shortly before lifting.

7. In preference to being left bare for periods of some months, nursery soil should be sown to cover and catch crops that will reduce erosion, keep down weeds, and prevent deterioration of soil structure and leaching of nutrients. Even a cover of weeds may reduce erosion and leaching and return a net benefit if disked in before producing seed or rhizomes.

8. Green manure, cover, and catch crops may have to be selected for their resistance to nematodes. During the winter and spring and until about July, such crops must be watched closely as a source of cutworm outbreaks.

9. Green manure, cover, and catch crops must be plowed in long enough before pines are sown to permit decomposition. One month is about the minimum safe period. Much longer is necessary with very heavy crops.

10. Large applications of organic matter, such as straw, sawdust, or even nonleguminous green manure crops, should not be turned in before a pine seedling crop without adding enough nutrients, especially nitrogen, to supply the micro-organisms decomposing the cellulose.

11. Fertilizers should not be incorporated in compost to the extent of more than about 4 percent by weight of nutrient salts, based on the air-dry weight of the compost material.

12. Materials and practices deserving of local trial are as follows: Previously little-used raw materials (especially sawdust) for composts and organic supplements; slowly soluble carriers of

nutrient elements, especially for green manure crops or for application before sowing pines; application of inorganic nutrient carriers periodically during the growing season, *but with care to wash them off the foliage promptly if applied in liquid form*; moderate late-season applications of potassium (which seem to improve survival); building up soil organic matter by applying sawdust and nitrogen to legume green manure crops; and leaving late-summer green manure crops on the ground as a mulch over winter instead of turning them under in the fall.

13. In the rare event of there being no mycorrhizae on the seedling roots, inoculation of the beds with mycorrhizal soil or cultures should be tried as a means of improving seedling development.

14. The final proof of the effectiveness of any nursery soil treatment, over and above its cost and its visible effect on the soil, is the plantation behavior of the seedlings it produces. The size and appearance of seedlings are not reliable evidence of their quality. Any drastic change in fertilizer treatment requires planting of the treated seedlings to verify their capacity for high initial survival.

NURSERY COSTS AND RECORDS

Costs of producing stock at U. S. Forest Service nurseries are broken down into the following components: Seed, seedling production, lifting and packing, soil fertility maintenance, building and equipment maintenance, building and equipment depreciation, and administration. Illustrative are data based on 196 million seedlings of four species produced in three U. S. Forest Service nurseries during 1937-41, largely with CCC labor at 25 cents an hour and WPA labor at variable but still low rates (table 22). All three nurseries were operated at approximately full capacity (20 to 25 million trees a year for the Ashe and Stuart; 3 to 5 million a year for the Ozark), under fairly well stabilized practices and with a fairly high degree of mechanization. Each nursery was operated by an experienced technical nurseryman whose time was charged to administration when not directly chargeable to specific operations. The data are the most complete and detailed available on the cost of large-scale production of southern pine nursery stock.

The percentages of total nursery costs charged to individual items of nursery operation (table 22) should be particularly useful guides to nursery management. Like costs in dollars, these percentages varied from nursery to nursery. For instance, the percentage cost of administration was much higher at the Ozark Nursery than at the Stuart because at the Ozark the salary of one technical nurseryman was prorated over only one-fifth as many trees. Under present practices, percentage costs of seedling production might be expected to decrease somewhat because of econo-

mies resulting from chemical weeding, and percentage costs of soil fertility maintenance to go up because of more attention to this important item. Such variations are logically to be expected. Except for these predictable variations, however, any great increase in the percentage cost of a particular item, over the percentages given for that item in table 22, should serve as a danger signal.

TABLE 22.—Average nursery costs per thousand plantable trees, Region 8, U. S. Forest Service, nursery years 1937-41 1

Species, nursery, and item of cost	5-year ² weighted average cost per thousand trees	
	Dollars	Percent
Longleaf and slash pines: ³		
Ashe Nursery:		
All, exclusive of seed.....	2.18	100.0
Seedling production ⁴53	24.3
Lifting and packing.....	.66	30.3
Soil fertility maintenance.....	.14	6.4
Building and equipment maintenance.....	.21	9.6
Building and equipment depreciation.....	.35	16.1
Administration.....	.29	13.3
Stuart Nursery:		
All, exclusive of seed.....	2.48	100.0
Seedling production ⁴83	33.5
Lifting and packing.....	.53	21.4
Soil fertility maintenance.....	.27	10.9
Building and equipment maintenance.....	.44	17.7
Building and equipment depreciation.....	.30	12.1
Administration.....	.11	4.4
Loblolly pine:		
Ashe Nursery:		
All, exclusive of seed.....	2.13	100.0
Seedling production ⁴50	23.5
Lifting and packing.....	.67	31.4
Soil fertility maintenance.....	.14	6.6
Building and equipment maintenance.....	.21	9.9
Building and equipment depreciation.....	.32	15.0
Administration.....	.29	13.6
Shortleaf pine:		
Ozark Nursery:		
All, exclusive of seed.....	4.99	100.0
Seedling production ⁴	1.42	28.5
Lifting and packing.....	1.09	21.9
Soil fertility maintenance.....	.23	4.6
Building and equipment maintenance.....	.83	16.6
Building and equipment depreciation.....	.73	14.6
Administration.....	.69	13.8

¹ Based on the 196 million trees of table 6; costs of seed are excluded.

² 4-year costs only in the case of loblolly pine.

³ Separate nursery costs were not kept for longleaf and slash pine.

⁴ Seedling production consisted of bedmaking, sowing, bird patrol, watering, cover removal, cultivation, hand and mechanical weeding, and spraying. Weeding was usually the largest single item (in some years larger than all others combined), and spraying one of the lowest.

For example, a disproportionately high percentage cost of seedling production should prompt the nurseryman to : (a) Scrutinize his operation for poor organization of work, waste motion, and failure to mechanize (731); (b) check the effects, upon cost per thousand trees shipped, of low tree percent; (c) make sure tardy or inefficient weeding has not run up his weeding costs (731); and (d) check the effect of culling on costs (fig. 30).

In the same way, a great rise in the percentage cost of lifting and packing should lead to a check on: (a) Organization and labor efficiency, including the possibility of reducing costs by installing mechanical grading tables ; (b) packing methods and cost of packing materials; and (c) the possible effect of sparse stands or excessive culling on lifting cost per thousand trees shipped.

By attention to such details, good nursery cost records, itemized for each species and geographic seed source as indicated in table 22, can be made a powerful tool for reducing both nursery costs and total planting costs.

One thing should be emphasized, however. Economies should never be carried so far as to reduce the technical excellence of the nursery operation. It is unwise, for example, to gamble on storing longleaf seed at air temperature until late spring sowing, merely to save a small charge for cold storage. Nor should a spraying be omitted, a weeding deferred, or any other sound practice trifled with, just to save a few cents per thousand trees. Above all, in permanent nurseries it never pays to make immediate savings in cash outlay at the expense of soil fertility. Often such economies boomerang by actually increasing the cost per thousand trees shipped, or by reducing the survival or growth of the planted trees.

Nursery records should be complete enough to supply the following data concerning any shipment of stock for which they may be required : Species and geographic source of seed (required

for all lots shipped) ; class, age, size (both average and range), and grade of seedlings, and specific rules by which graded ; occurrence of insects or diseases possibly affecting plantation survival, and degree to which controlled; length of root pruning; and dips or sprays applied at lifting. For each seedling crop as a whole there should be recorded the temperature, humidity, and rainfall under which it was grown. Each year, records, as guides to future operations, should be kept of date and rate of sowing; duration of covering; the initial catch of seedlings; weeding, including methods, effectiveness, and injuries to the seedlings; watering dates and amounts; nature and dates of injuries from pests, resulting percentages of mortality and culls, and the nature and effectiveness of control treatments; the final stand, expressed both as percent of seedlings originally established and as number per square foot; and the percentage of plantable seedlings in the final stand. For intelligent application of treatments and purchase of supplies, there must be some records of the dates of development of secondary needles and winter buds, life of equipment, quantity of moss used per bale, numbers of seedlings packed per bale, and the like.

Nursery soil maintenance and treatment records and maps should include : Method of ground preparation; fertilizers, soil amendments, crop rotations, and green manure crops (species, fertilization, weight per acre produced, and stage and date of turning under) ; soil fumigants; chemical weed control ; weed populations (species, amount, and whether allowed to form tubers or go to seed); outbreaks of soil insects and diseases, with exact locations, dates of appearance, treatment, and control ; location, severity, and control of erosion; periodic measures of pH concentration and of soil organic content ; and seedling crops removed, with dates, numbers per square foot, and approximate total weights per acre.

PLANTING

The surest means of attaining success in planting is to keep all phases of the process in balance (313, 430). A moderate amount of special protection and care after plantations have been established is often more important than special refinements of planting methods. In all situations the best planting techniques depend for complete success upon correct choice of species, seed source, and spacing in relation to the planting objective, and upon the delivery of satisfactory nursery stock. Some failures may be unavoidable, and are best offset by budgeting funds for replanting (p. 164). Such replanting is cheaper than a general overrefinement of planting technique in an attempt to prevent all failures.

This chapter supplies general information on planting technique. Men familiar with the individual sites to be planted are in the best position to diagnose local conditions and fit accepted or new methods to them. In doing so, the survival and growth of nearby plantations are invaluable guides.

PLANTING SURVEYS

Most large tracts require planting surveys 1 to 3 years in advance of planting if they are to be reforested with best results at minimum cost.

Modified to suit local conditions, the planting survey system used by the U. S. Forest Service (736) should meet the needs of large-scale planters of southern pines. In this system, preliminary reports are drawn up describing the general area considered for planting. These reports allow the area to be narrowed down to those tracts which are to be planted in the next 1 to 3 years, and for which an intensive survey may be necessary.

Each preliminary report is compiled under the following headings : (a) General description of the tract, its location and boundaries, and approximate gross acreage; (b) history of tract, with special emphasis on logging, burning, grazing damage, agricultural use, erosion, and other influences which have made planting necessary ; (c) kind, quality, and estimated degree of natural forest reproduction, with stocking expressed as percentage of all 1/1000-acre quadrats occupied, not in terms of total seedlings per acre; (d) approximate stand of brush and weed trees (expressed as in c above) , with notes on size and on probable impediment they offer to natural reproduction and to planting; (e) condition of site—especially soil type and drainage—and apparent capacity to grow

timber ; (f) rodents, insects, and diseases characteristic of the area ; (g) extent and nature of use by livestock, and modifications necessary to protect planted trees; (h) fire history and hazard, and steps necessary to control fires effectively; (i) probable cost of intensive planting survey ; (j) recommendations for or against making an intensive survey; and (k) sources of the information presented.

The preliminary report is based as far as possible on existing information and personal knowledge. Only such field inspections are made as are essential to confirm doubtful points (such as extent of natural reproduction, or presence of insects or diseases), or to cover areas not described in existing records. Aerial photographs are useful sources of information, but must be checked by field examination wherever pine seedlings, especially longleaf, may exist but are not visible from the air.

For old fields, uniformly denuded tracts of former longleaf pine land, and the like, clearly in need of planting and presenting no complications, the preliminary report is made complete and final by including the net acreage to be planted and the numbers of trees required.

The principal object of the intensive survey of more complex tracts is to learn the net acreage to be planted; to calculate as closely as possible the amount of nursery stock needed for each tract; to locate all roads, firebreaks, sources of water, impassable ground, and other features that may affect planting (including the feasibility of machine planting) ; to estimate the fencing, firebreak construction, and road construction necessary, with costs and locations ; and to determine the need for ant eradication, gopher control, prescribed burning, and the like, with costs and locations.

Four principal kinds of evidence are considered in classifying land : (1) Immediately or potentially merchantable stand of timber species ; (2) established natural seedlings of merchantable species; (3) potential natural reproduction from existing trees capable of bearing seed ; and (4) presence of brush or weed trees that might hinder planting.

No definition of merchantable stands will be attempted here. There is, however, an increasing tendency to plant openings in sparse or irregular sapling stands, rather than to wait for them to be filled by natural reproduction (p. 140).

With regard to natural reproduction already on the ground, Region 8 of the U. S. Forest Service has defined plantability in terms of percentages of

all 1/1000-acre quadrats occupied by one or more established seedlings, as follows : Land with less than 11 percent of all quadrats occupied is given the highest priority and that with 11 to 24 percent of the quadrats occupied receives second priority. Land with 25 to 49 percent of the quadrats stocked is regarded as possibly plantable. No attempt is made to plant areas throughout when 50 percent or more of all quadrats are stocked.

Seldom, however, except in old fields, does entirely bare land exist uniformly over one "forty" or square mile. Instead, irregular areas of all four classes of stocking, from an acre or less to several hundred acres in size, are interspersed. In such cases, it is accepted practice to bring the stocking of all of these, including even the best stocked, up to about 1,200 trees per acre (assuming 6- by 6-foot spacing) while the crews are on the ground. Therefore, on all areas selected for planting, the man who orders the nursery stock must know not only the net acreages of each of the four stocking classes, but also the average number of quadrats per acre still remaining to be stocked in each.

In predicting natural reproduction, it is wise to count on little from fewer than 5 to 10 seed trees per acre, to check all areas of possible reproduction by making a rapid reconnaissance the summer or spring before planting, and to have alternative planting areas prepared if reproduction actually has taken place.

Region 8 of the U. S. Forest Service has hitherto classified land as unplatable if 50 percent or more of all 1/1000-acre quadrats have been occupied by brush or weed trees capable of suppressing or killing out the planted pines. Because of urgent need to restore pines to many brushy areas and because of recent advances in the technique of killing undesirable trees (p. 145), this criterion may have to be amended. Nevertheless, it remains a useful index to probable costs of site preparation and planting, and to plantation survival and growth.

The data on merchantable or near merchantable timber, actual and potential reproduction, and brush and weed trees are collected along paced lines run by compass at 20-chain intervals through uniform areas such as denuded longleaf pine land and at 10-chain intervals on more varied sites. The cruise lines are run at right angles to taped base lines laid out parallel to main topographic features and tied to section corners or other established points. Every 2 chains on cruise lines 20 chains apart, and every 4 chains on lines 10 chains apart, 3 concentric plots are taken, as follows :

1. A one-fifth-acre circular plot (radius, 52.7 feet), on which seed trees are counted.
2. A one-fiftieth-acre circular plot (radius 16.7 feet), on which saplings and poles 4.5 feet high to 8 inches d. b. h. are counted.
3. A 13.2-foot square, subdivided into four 1/1000-acre quadrats each 6.6 feet on a side, each of which is recorded separately as being occupied or not occupied by (a) an established seedling or

seedlings of desirable species and (b) a bush or weed tree. (Any quadrat is counted as occupied if it contains a sapling, or if more than half of it lies under the crown of a pole or seed tree.)

With either line-plot spacing described, this system gives for every forty acres the seed trees on 2 acres, the saplings on one-fifth acre, and the presence or absence of natural seedlings and of brush on 40 separate 1/1000-acre quadrats. These data are converted into the averages required to summarize the intensive survey.

Pertinent features lying between cruise lines are sketched on field maps (scale usually 4 inches to the mile). On the same maps are shown areas infested with ants or gophers, as a guide to crews controlling these pests, and any other information important to have during planting. Data on seed trees, stocked and unstocked quadrats, etc., are recorded on suitable tally sheets, by line and plot numbers corresponding to those shown on the field maps. The data from the field map sheets and tally sheets are summarized on planting-plan maps (scale usually 2 inches to the mile), in tables of net acreages to be planted and of quantities of nursery stock required, and in a detailed written statement following essentially the outline used for the preliminary report.

THE PROBLEM OF INITIAL SURVIVAL

The earliest indication of how successful a southern pine plantation may be is its initial 's survival. Final results may be acceptable even when initial survival is only fair, provided later mortality is low and growth is good. Each decrease in initial survival, however, increases the average cost of the trees that reach merchantable size, and correspondingly decreases profits. By irregularly opening up the stand, low initial survival may increase fusiform-rust infection or otherwise reduce the quality of the products. It may have legal complications, as in payment of benefits for agricultural conservation practices. Lastly, there are minimum levels of initial survival below which nobody can accept plantations as successful.

The planter is more immediately concerned than anyone else with the whole problem of initial survival. His judgment in accepting stock and competence in planting it largely determine whether initial survival will be high. If it is low, he is the first to discover the fact, and is in the best position to learn the reason. If an error in planting technique causes failure, only the planter can correct it. Even when the trouble lies in the quality or condition of the stock delivered from the nursery, the nurseryman can learn of and correct the trouble only if the planter calls it to his attention. For

⁴⁸ Survival the first October to December after planting, unless otherwise specified. The survival in June often is a satisfactory index, but becomes misleading if summer mortality is high.

these reasons the planter must understand the effects of both nursery and planting practices upon initial survival.

Planting costs money and effort. Death of any large percentage of the planted seedlings cannot be glossed over; it is conspicuous and disturbingly final. Nobody likes it. Therefore much investigative effort throughout the southern pine region has concentrated upon influences thought to affect initial survival. The general results of these investigations may be summed up as follows.

Except possibly in the Piedmont, initial survival of planted southern pine has been much more variable, and often much lower, than is generally realized. In many instances it has been 60 percent or less (194, 279, 582). In controlled experiments over an 11-year period, survivals of stock planted under good to ideal field conditions (p. 104) ranged as low as 28 percent.

Although necessary to it, high initial survival does not insure high survival when the crowns close or when the trees reach merchantable size (582). Under the plantation management practices that have so far prevailed in the South, this has been most frequently true of longleaf pine, which, in the absence of prescribed burning to control brown spot, has tended to suffer continuing mortality between the second and tenth or sometimes between the tenth and twentieth years (fig. 8, p. 20). Planted loblolly (fig. 8), slash (fig. 8), and shortleaf pine are more likely to maintain a nearly constant level of survival from the end of the first year until after the crowns have closed, as have also pines in other regions (282, 322, 508, 633, 686, 800). In zones of heavy fusiform rust (fig. 4, p. 8), however, slash pine may suffer continuing mortality like that of longleaf. Other exceptions are discussed under plantation injuries.

Incorrect planting is not the only, and may not be the most frequent, cause of poor initial survival. Assuming arbitrarily that all failures are the planter's fault often results in costly annual losses which could easily be prevented by correcting some error in planting policy or nursery practice.

Exaggerated notions of the effects of planting technique on initial survival have sometimes led to overrefinements of the planting process, including those of tool design and manipulation. Within wide limits, design and use of tools have little influence on survival; their principal effects are on efficiency of labor output.

The most widespread, frequently occurring, and generally feared cause of low initial survival in southern pine plantations is not fire, animals, insects, or disease, but drought (161, 194, 348, 384, 474, 525, 632, 666). This has been found true of direct-seeded southern pine also (470), and of planted American pines in general (218, 263, 405, 479, 564, 617, 633, 647, 788). Drought, in the sense of loss of more water from the tops than can be replaced through the roots, is insidious in that it may affect seedlings not only through dry winds,

heat, and lack of rain, but also through unfavorable soil texture, lack of soil organic matter, freezing of the soil, competing vegetation, physiological condition of the planting stock, injury to roots during lifting, foliage sprays applied at lifting time, too high setting of the seedlings in planting, planting slits left open at the top, and doubtless in other ways. It is the more troublesome and baffling because the planter can neither escape dry years or briefer dry spells, nor (especially in erosion or flood control) confine his efforts to the moister sites. For these reasons, the majority of attempts to explain or improve poor initial survival must take into account the numerous different ways in which drought may have injured the seedlings.

The ability of planted southern pines to overcome drought and attain high initial survival seems to depend, perhaps even more than that of pines planted in other regions, upon formation of considerable new root tissue promptly after planting (p. 108) (384, 474, 628). The climate of the southern pine region and the inherent characteristics of the southern pines themselves encourage such tissue formation; the nurseryman may modify it favorably or unfavorably, directly or indirectly, in many different ways; the planter has little chance of affecting it except by flagrant abuse of the stock.

Influences which affect initial survival through choice of species and in similar ways have been discussed on pages 4 to 23 or are treated under grades of nursery stock or plantation injuries. The following sections discuss the way site preparation, season and weather, condition and care of stock, and methods of planting affect initial survival. These are influences which the planter can circumvent or control, either through his own knowledge and efforts, or with the help of the nurseryman. Most of the information presented is from studies on cutover longleaf pine land at Bogalusa and Alexandria, La. (pp. 198-200). The studies included 430 different treatments affecting initial survival, applied to 1,170 separate lots of stock totalling 143,000 seedlings of the 4 principal southern pines.

SITE PREPARATION

The common ways of preparing sites before planting southern pines are by burning, by furrowing, and by scalping spots.

In rigorous studies on the Johnson Tract (p. 200) in several different years, burning immediately or one year before planting, or furrowing the site or scalping spots, produced neither large enough nor consistent enough increases in initial survival to justify general use on cutover longleaf pine land. In a few instances these measures reduced survival significantly.

Excellent survival on thousands of acres of unprepared sites both within and outside the longleaf pine types, from Georgia and Florida west-

ward to Arkansas and Texas, supports the conclusion that site preparation is generally unnecessary to satisfactory initial survival in the southernmost part of the southern pine region. The same seems true of most southern pine planting sites in the Central, Piedmont, and southern Appalachian regions (283,322, 463,513), and presumably in the Atlantic Coastal Plain also.

Site preparation may nevertheless reduce costs of planting or of plantation protection enough to be worth while even though it does not increase, or actually somewhat decreases, initial survival. Moreover, on some adverse sites, site preparation may be more important to good initial survival than it is on the commoner sites on which it has been systematically studied. The different methods of site preparation and suggestions for their use which follow, however, should be examined critically in the light of local conditions, and tried experimentally before large-scale adoption.

Burning

Burning is the cheapest form of site preparation. It usually costs only a few cents an acre. The essentials of prescribed burning are outlined on page 163, and pertinent details concerning the effects of burning are available in the literature (104, 141, 142, 179, 286, 290, 328, 329, 335, 385, 506, 625, 536, 651, 652, 653, 709, 726, 745, 750, 788).

On many sites, burning either immediately or a year before planting makes hand planting easier, and burning immediately before makes machine planting very much easier. Burning immediately before planting gives the planted trees almost complete fire protection through the first growing season and may reduce fire hazard through the following winter. It frequently enables planted slash or loblolly pine seedlings to overtop gallberry or waxmyrtle without further aid. Burning off old, heavy grass rough immediately or even 1 year before planting may prevent serious injury of planted trees by rodents, especially cotton rats.

On sites already partly stocked with natural longleaf seedlings, prescribed burning immediately before planting usually does not kill the natural seedlings, and may even save them from brown spot. It also enables the planter to see which planting spaces are already occupied. If longleaf seedlings are planted, it delays and reduces their infection by brown spot.

These advantages of burning must be weighed against several disadvantages.

Burning kills small slash and loblolly pine seedlings already established on the site, and may kill longleaf after it has first started height growth. It kills back small established shortleaf pine seedlings, though they usually sprout after fire.

The earlier growth of grass on burned than on unburned areas may cause cattle to concentrate on the planting site. The cattle sometimes browse

the planted pines severely for lack of other roughage or green feed and may also injure them by trampling.

Sometimes burning immediately before planting causes serious mortality among the planted seedlings from severe freezing or, when dry weather follows planting, from extreme exposure to sun and wind. Burning should therefore be used with caution in localities where freezing or dry spells in the winter or early spring are to be expected.

Furrowing

Plowing furrows, although cheaper than scalping spots by hand, is more expensive than burning; in one large-scale operation, furrowing at 8-foot intervals for planting at 6- by 8-foot spacing made up 8 percent of the total planting cost (666). Purely as a means of improving initial survival, it is a doubtful investment on the great majority of southern pine planting sites. In most places it has been abandoned as unnecessary even though (in addition to any effects it may have on survival) it makes bar or mattock planting quicker and easier, simplifies control of spacing, and helps protect the trees from fire for the first year or two after planting (194, 283, 321, 463, 513, 750).

Furrowing is used, and apparently to good advantage, on sites heavily vegetated or deficient in rainfall (210, 449, 513). Moist sites occupied by dense stands of gallberry and palmetto are a case in point, as are drier sites occupied by Bermudagrass, carpetgrass, or lespedeza (321). It has also improved both initial survival and later growth on flat, very wet sites, either poorly drained "crawfish flats" or the distinctive low pockets known locally as "savannas" (523). On these poorly drained sites the furrows are located to improve drainage as much as possible, and the trees are planted, not in the furrows but on the furrow slices, as has been done on similar wet sites in the Lake States (699).

Except on excessively wet ground, furrows on southern pine planting sites usually are made only 2 or 3 inches deep, just deep enough to prevent regrowth of grass from the roots. On sandy soils, deeper furrows result in too much movement of sand into the furrows; where shallow surface soils overlie stiff subsoils, deep furrows may place too much of the seedling root system in the less fertile, less penetrable subsoils. Furrows should be plowed at least 2 or 3 months before planting, to let rain settle the loose soil. They often remain plantable for a year and sometimes for 2 years after plowing. Narrow furrows made with a turning plow are preferred for longleaf because they minimize silting; wider furrows, made with a scooter stock, middle breaker, disk, or special fire-line plow usually are preferred for other species. Furrowing on or near the contour is preferable except on poorly drained sites, and is essential on steep slopes or any easily erode soil.

Scalping

Scalping consists of removing the surface vegetation from spots 15 to 20 inches across (8 to 10 inches under Central States conditions (513)), cutting just deep enough to prevent regrowth of the grasses from the roots. In mattock planting, scalping usually is done with the mattock at the time of planting; in bar planting, it usually is done in advance, with mattocks or heavy hoes. It has been substituted for furrowing in a generally successful attempt to reduce erosion and silting, but usually costs more because of the hand labor involved. With occasional exceptions (321) it has resulted in much the same initial survival as has planting in plowed furrows or in unmodified rough (249, 283). It is not recommended except where local experience or tests show that it meets a need for reducing competing vegetation and increases initial survival enough to justify the extra cost.

Subsoiling

Breaking up stiff subsoils or existing hardpans with a "bull tongue" or "ripper," in conjunction with furrowing, has been tried in a few places, but the results do not justify recommending this practice as a means of increasing initial survival (283, 321).

Strip Plowing

The plowing of broad strips or of the entire site is too expensive for general use. Although it has sometimes increased early height growth, it has rarely improved and has sometimes reduced survival (194, 283, 321, 463). Because it may increase height growth, it should be avoided in planting loblolly and slash pines where risk of fusiform-rust infection is high (pp. 160 and 168).

Special Measures on Severely Eroded Land

In extreme cases, seedlings cannot even be set in place on eroded soils until gully banks have been plowed or blasted down, check dams or soil-collecting trenches have been built or dug across gullies, or natural hollows or holes dug with post-hole diggers have been filled with topsoil from other areas (320, 321, 322, 488, 489, 491, 492). These and other special methods of preparing eroded sites are, however, expensive, and it seems probable that site preparation has often been overdone. Much erosion-control planting has been astonishingly successful without it, and in many instances over a wide territory (283) special measures other than mulching - have had no apparent effect on survival.

Mulching of the kind discussed here consists of "applying on the ground a thin, uniform coating

of ** pine branches, leaf litter, grain straw, *Lespedeza sericea* stems, or cane bagasse. It does not include the practice, often used ** in the South, of throwing brush haphazardly into gully bottoms and ditches, or of smothering the ground with straw as is commonly done for winter protection in the North" (264). Mulch may be applied broadcast over the site well in advance of planting-this may make the soil much looser and moister at planting time-or may be applied broadcast or around individual trees at or after planting. McQuilkin spread Virginia pine litter or broomsedge (*Andropogon* sp.) 2 inches deep in 18-inch circles around planted trees; Hendrickson mulched the entire site with pine straw (321, 471). The degree of mulching can be adjusted to local needs, and methods developed for road-bank fixation (5, 347) may be useful on very rough sites.

On bare and particularly on eroded or actively eroding sites, mulching has greatly increased both survival and early growth of southern pines on different soils in many different localities (210, 321, 322, 415, 471). Natural litter accumulation-"self-mulching"-under pines on moderately eroding sites has conspicuously improved growing conditions in the same way. Gibbs indicates that, in establishing plantations on eroding land, mulching improves survival more than does plowing, cultivating, fertilizing, subsoiling, ridging, furrowing, gully-bank sloping, or the construction of check dams (283). Mulch greatly reduces rainwash (385, 490, 726) and frost-heaving (264, 405, 471, 798). It adds much-needed organic matter to adverse sites (693, 709, 788), restores beneficial soil fauna. (352), and may encourage the development of beneficial mycorrhizae (231, 309, 541) where soil abuse has destroyed them. Mulching has greatly benefited both soil and trees in plantations on wind-eroded soils in the North, and in some instances has been found essential to survival on such sites (43).

Brush Elimination

Elimination of brush in advance of planting may be necessary on some sites to give reasonable chances of good initial survival as well as to permit planting at economical speeds. Details are discussed in the section on planting among hardwoods (p. 141).

Allocation of Treatment to Site

The planter can improve average initial survival at minimum cost by confining site preparation and other preplanting treatments to the trouble spots. The principle is the same as that of assigning two different species or stock grades to different soils even though both are equally adapted to the climatic and other hazards of the area as a whole (210, 283, 471, 472, 488, 632), and as that under-

lying attempts to develop special drought-resistant stock for adverse sites (474, 479, 552, 646, 647).

Furrowing, for example, can be confined to portions of old fields occupied by Bermudagrass, carpetgrass, or lespedeza; furrowing and planting on the furrow slice, to savannas; prescribed burning in advance of planting, to gallberry thickets or to areas of grass rough old and heavy enough to harbor cotton rats. Where only parts of an area are heavily infested with rabbits, use of slash or loblolly stock sprayed with rabbit repellent, or late-season planting of these species, can be confined to these infested parts. Where both longleaf and slash pine are to be planted on an area infested throughout by rabbits, the longleaf can be planted at the beginning and the slash at the end of the season (p. 153). Since frost-heaving is worst with small stock, on heavy soils, and on sites unprotected by vegetation, average survival in the northern part of the southern pine region can be increased by using only large stock and planting only on predominantly grassy and sandy sites until the danger from frost is over for the year (9, 210, 286, 471, 513, 616).

SEASON AND WEATHER

Throughout most of the lower South, the optimum planting season extends from about December 1 to March 1. In southern Georgia and Alabama and northern Florida the optimum season ends a month or 6 weeks earlier (fig. 4), but in the northernmost parts of the southern pine region, and especially at high elevations, it may extend through April.

In practice, the beginning and ending dates of planting are most likely to be determined by: (a) The occurrence of enough fall or early winter rain to soften and thoroughly moisten the soils of the planting sites; (b) spring temperatures and other influences (possibly including *vigorous* top growth of seedlings) that make trees planted after a certain date unlikely to survive well; and (c) in the northern parts of the southern pine region, a protracted period of freezing weather that separates late fall from spring planting seasons.

Lifting and Shipping Dates

Unless prolonged winter rains make the nursery soil too wet for lifting, shipping ordinarily can be adjusted to the needs and convenience of the planter. Within the acceptable period for planting, the nurseryman must neither lift so far in advance of shipment that the seedlings will deteriorate in nursery storage (p. 102), nor lift in freezing weather. Aside from these two obvious points, most discussion of the effect of lifting and shipping dates upon survival has centered upon the apparent dormancy or nondormancy of the seedling tops at lifting time.

Top Dormancy

The best evidence suggests that, while near dormancy of tops may be desirable, nondormancy alone seldom explains low initial survival. Dormancy or near dormancy of southern pine seedling tops seems to result from a combination of temperature, length of day (353, 573), and stage of development of the stock itself. During the optimum season for planting, all three of these influences normally are such as to cause near dormancy, but not necessarily complete dormancy. Southern pine seedlings seldom need be culled merely because the tops are in a state of active growth (p. 110).

A sudden drop in initial survival percent has sometimes coincided with a resumption of seedling growth in the nursery, notably in slash pine in Florida about 1937. But slash pine planted late in March, after the tops had not only opened their buds but had made 2 to 3 inches of new growth, has also survived extremely well, notably at Bogalusa, La., and in Jackson County, Miss., in the 1920's. In the 1937-38 slash pine grading study previously described, there was no consistent association between dormancy and survival (fig. 33); any effects of dormancy were overshadowed by seedling size and especially by the effects of the environments in which the different lots of stock developed.

In any event, overwinter changes in the condition of the winter buds seem characteristic of southern pine nursery seedlings; slash pine especially is likely to elongate and open existing buds and to form new ones during the lifting and planting season (fig. 24). In 1937-38 and 1938-39 studies of the effect of date of planting upon initial survival, the average survival percentages of southern pine seedlings planted at 2-week intervals during the periods November 23 through March 15 fluctuated far less than did the percentages of seedlings having visibly nondormant tops.

The 1937-38 study showed that planting sometimes may be safely extended at least 4 to 6 weeks beyond the general breaking of top dormancy in the spring (fig. 35). In this study the significant variations in survival within different species during the period November 23 through March 15 were not associated with identical planting dates, nor was there any consistent association of decreases in survival with increases in percentage of seedlings having nondormant tops. In the 1937-38 study the lowest survival for any species planted between November 23 and March 15 was 67 percent; in the 1938-39 study, the lowest for any species planted between November 4 and March 10 was 87 percent. In the 1938-39 study, longleaf survived April and late March planting conspicuously less well than did the other 3 species. Other less exacting and comprehensive studies on the Johnson Tract and at Bogalusa, La., have given results essentially in harmony with those described.

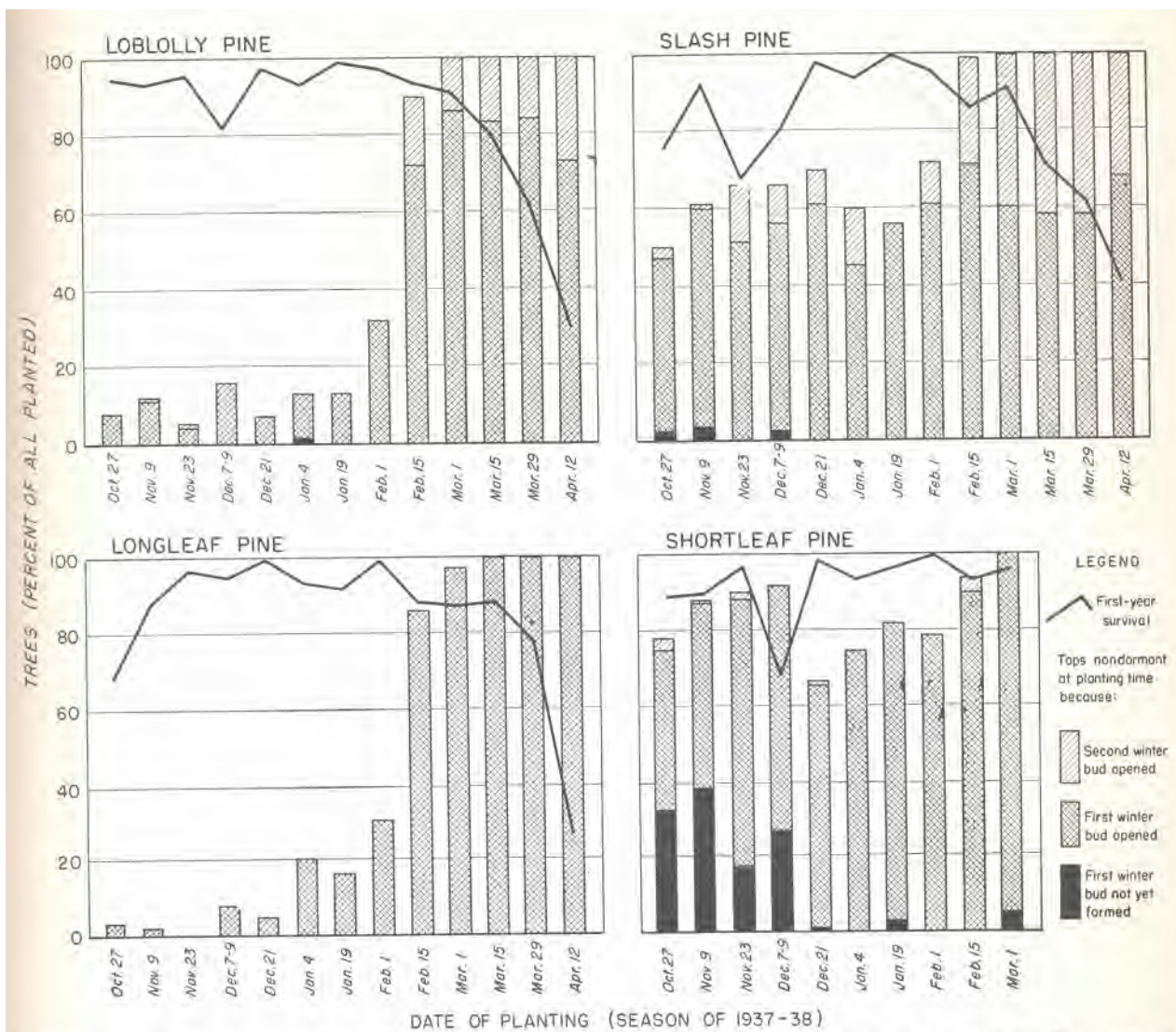

FIGURE 35.—Effects of date of planting upon percentages of southern pine planting stock with visible nondormant tops, and upon first-year survivals, J. K. Johnson Tract, La.

Although these studies show a reasonably good chance of high survival on cutover longleaf land in Louisiana from planting in the December 1 to March 1 season or even considerably beyond it, they give no absolute assurance. In a year of extraordinary weather conditions, severe late fall or early winter drought might reduce survival; or excessive fall rain might reduce it by lowering the physiological quality of the nursery stock (p. 109). Neither can it be expected that these results will apply exactly, throughout the lower South, on lighter, sandier soils in zones of lower spring rainfall (p. 7). Under such conditions initial survival seems to fall off if planting is continued past mid-February or even mid-January (194), and the optimum planting season seems to be December.

Where protracted cold weather splits the planting period into two seasons, a fall and a spring, general experience with the southern pines indicates much better initial survival from planting

in the spring (161, 162, 210, 361, 449, 471, 513). Part of this superiority results from decreased frost-heaving, but part may result from the more prompt resumption of root growth (p. 123) after spring than after fall planting. A similar favorable development of new root tissue after spring planting has also been noted in the Lake States (405, 622).

As long as weather and the physiological condition of the stock remain favorable, planting after rather than before January 15 to February 15 is likely to increase the initial survival of loblolly, slash, and shortleaf pines wherever rabbits are abundant (p. 152).

Weather During Planting

Two comprehensive direct tests on the Johnson Tract, within the normal planting periods of different years, showed no consistent, significant dif-

ferences in survival as a result of planting longleaf and slash pines on sunny days, on cloudy days, just before rain, just after rain, and in the middle of long dry periods. Although not conclusive, these results suggest strongly that, within wide limits, weather at planting time is not an important cause of initial failure, and should not, without clear supporting evidence, be made an excuse for failures from controllable causes.

Considerable evidence from several localities in different years indicates, however, that freezing of the seedling roots during planting, or freezing of the ground for several or all of the first 10 days after planting, seriously reduces initial survival. This form of loss has been noted particularly with slash pine but may affect other species also. Its occurrence suggests that planting be stopped and stock be heeled-in or otherwise protected when temperatures drop below freezing or a cold wave approaches.

CONDITION AND CARE OF STOCK

The condition of the stock when planted affects initial survival as directly as does site preparation, weather, or planting method. The planter's responsibility for keeping stock in good condition from arrival until it is planted is equalled by the nurseryman's responsibility for producing seedlings of high quality and shipping them in good condition and properly packed. To detect mistakes by either the nurseryman or himself, the planter must check the condition of the seedlings both on arrival and during planting.

Root Length

Because the root systems of 1-0 southern pine seedlings are too big to dig up, pack, or plant in their entirety at reasonable cost, root pruning is an essential part of lifting and packing. Correct root length is therefore largely the nurseryman's responsibility. The planter should sample the stock on arrival to see that root lengths in general are satisfactory, and inspect it in more detail during planting to make sure that appreciable percentages of the roots are not too long or too short. He must also see that the roots are not broken or cut short during heeling-in or planting.

Two studies of slash and longleaf pine on the Johnson Tract have strongly confirmed the practice of pruning root systems to 7 or 8 inches for planting on cutover longleaf pine land ; of accepting seedlings with root systems snapped off as short as 5 inches ; and of culling seedlings with root systems shorter than 5 inches. These studies, on somewhat different soils and in different planting seasons, gave remarkably consistent results. Pruning to 10 inches gave consistently and in some instances significantly poorer survival than prun-

ing to 6,7, or 8 inches." Pruning to 4 inches gave satisfactory survival in one season but not in the other; root systems cut this short clearly cannot be depended on for good results. Pruning to 3 or to 2 inches resulted in very significantly decreased survival in both years, and also made correct planting slow and difficult; pruning even to 2 inches, however, did not cause complete mortality. These findings are in general supported by data presented later (table 23). Experience throughout the southern pine region has shown that they are also applicable to loblolly and shortleaf pines and to a majority of southern pine planting sites.

Loss of Lateral Roots

Loss of lateral roots by breakage is one of the most frequent and important causes of low initial survival. In two studies on the Johnson Tract in different years, loss of all lateral roots very seriously reduced survival, particularly of slash pine. and of longleaf pine especially on poor (sandy or droughty) sites, regardless of how much of the taproot was retained (tables 23 and 24) ; it also greatly reduced the subsequent growth of such longleaf seedlings as survived (229). Survival was high even with the greater part of the taproot removed, provided a good system of laterals was retained above the point where the taproot was cut (table 23). Loss of only *half* the laterals seriously reduced the survival of longleaf pine on poor sites, and caused near failure of slash pine (table 24).

Laterals are most likely to be lost in the nursery, but heavy losses may also occur during several phases of planting. Loss in the nursery is most likely to result from operating mechanical lifters in soil that is too dry, or at too high speed in any soil, and from careless or too rapid freeing of the roots from the earth by hand after the lifter has passed. Two very common causes of root injury during planting are vigorous instead of gentle separation of seedlings that have been packed tightly together in bales or heel-in beds, and rough removal of seedlings from a container in which they have been carried upright (fig. 37, *A*, p. 134) instead of on their sides (fig. 37, *B*). Unless carefully trained and closely watched, workmen sometimes deliberately strip off lateral roots to make bar planting easier.

The most conspicuous evidence that laterals are being lost consists of masses of developing root tips, mycorrhizal rootlets, and detached whole lateral roots in the soil of the seedbed, or in packing

²²⁹ Almost identical results have been reported with gnyaudé. In this species the number of new roots initiated on the old taproot, after lifting, was proportional to the length of the taproot, up to a limit of 7 inches, but on taproots 9 and 12 inches long there was a significant decrease or delay in their formation (278). An identical pattern of new root formation may well have caused the pattern of survival of both slash and longleaf pines on good sites but without lateral roots, in table 23.

material, heel-in beds, or planting trays. The loss is hard to detect on the seedlings themselves except by examination with a hand lens after washing. Half to three-fourths of the laterals may be removed from a previously intact root system without altering its general appearance enough so that even skilled graders will be aware of the damage.

TABLE 23.—*Effects of lateral roots on first-year survival of planted southern pines with root systems pruned to specified lengths*

Treatment	Slash pine		Longleaf pine	
	Good site	Poor site	Good site	Poor site
No modification other than roots pruned to:	<i>Percent</i>	<i>Percent</i>	<i>Percent</i>	<i>Percent</i>
10 inches	99	100	100	99
8 inches	100	96	99	98
6 inches	99	94	99	86
4 inches	99	97	99	90
2 inches	92	86	85	86
All lateral roots removed and roots pruned to:				
10 inches	38	3	60	80
8 inches	44	1	88	63
6 inches	56	1	78	76
4 inches	18	2	73	45
2 inches	22	1	36	1
Taproot pruned to 3 inches and other roots to 8 inches	99	99	100	91

TABLE 24.—*First-year survival of southern pines planted on good and poor sites after removal of different proportions of lateral roots*

Portion of lateral roots removed ¹	Slash pine		Longleaf pine	
	Good site	Poor site	Good site	Poor site
	<i>Percent</i>	<i>Percent</i>	<i>Percent</i>	<i>Percent</i>
None	77	40	81	61
One-half ²	36	24	80	39
All	6	1	42	11

¹ Entire root system pruned to 8 inches in usual manner; lateral roots, in the proportion indicated, then pruned from the main root.

² This treatment left enough lateral roots so that the loss would ordinarily pass unnoticed on the grading table.

Packing and Transit

Inadequate or improper packing, an obvious cause of low initial survival, has been discussed (p. 100). Even when the planter transports the stock, the nurseryman must anticipate its probable treatment in transit, pack it accordingly, and often

instruct shipping agents or truck drivers how to handle it.

Drying and heating are the two principal sources of injury during transit. If the stock has been properly packed, drying need not be feared except under extraordinary circumstances. Heating, however, is an ever-present danger whenever more than a very few thousand seedlings are shipped together. When it occurs, part of the stock is always lost outright, and the survival of the rest usually is greatly reduced. Stock which has heated in transit ordinarily can be recognized by its musty or fermented odor, discoloration of foliage or roots, often some mold, and, usually, perceptible warmth to the touch upon arrival. Precautions against heating have been given on p. 100.

Stock Storage

Even under the most favorable conditions, some stock must be stored for brief periods at both the nursery and the planting site. Bad weather and other interruptions of the planting schedule increase both the quantity stored and the duration of storage. Ordinarily the nurseryman has the better facilities for storage but the planter is better able to minimize the time any one lot of stock is stored. Heeling-in has always been a principal means of storage. The U. S. Forest Service bale (p. 227) has also been widely used, especially for storage between receipt at planting headquarters and delivery to the local planting site. Uncertainty concerning the effects of these and other storage methods upon initial survival has, however, resulted in attributing many plantation failures to stock storage, and in specifying elaborate and often impracticable refinements of heeling-in.

During 1934-35 through 1940-41 more than 15 thousand seedlings, half longleaf and half slash pine, were stored in differently treated lots of 100 seedlings each, for various periods up to one month, in heel-ins, bales, tubs, and commercial cold storage, and out-planted on the Johnson Tract, in an attempt to get practical answers to recurrent questions about stock storage. The results showed conclusively that :

1. Stock in good condition to start with can be heeled-in safely, during the ordinary winter planting season, for periods of at least 21 to 28 days (directions for heeling-in are given on p. 226). Supplementary observations showed, however, that heeling-in for periods as long as 70 days, especially toward the end of the planting season, may seriously reduce initial survival.

2. Some widely publicized specifications for heeling-in are unnecessarily exacting; in particular, sandy soil and daily watering are not essential, and bundles of 50 or 100 seedlings need not be opened before heeling-in. In one experiment, longleaf and slash seedlings were heeled-in for 28 days in 14 different ways : with and without shelter

from wind and sun ; with and without artificial watering ; on well-drained sandy soil, and in heavy clay flooded daily to deprive the roots of oxygen ; for all 28 days in the field, and with the 28 days variously divided between nursery and field heel-ins ; not only bundled, but with the test seedlings separated from the walls of the trench by an extra layer of bundles on each side. In all treatments, however, the root systems and up to one-fifth of the tops were completely covered with soil, leaving the tops at least four-fifths exposed to the air. Of the lots of seedlings stored in these various ways, the two poorest survived 89 and 90 percent respectively, and 23 of the 28 lots had initial survivals above 95 percent. The comparable random check lots from the same beds, lifted and planted the same day the stored stock was planted, survived 90 and 93 percent.

3. Stock can be stored satisfactorily in U. S. Forest Service bales for periods up to 4 weeks if the bales are kept moist and are not allowed to heat. In one study, longleaf and slash were stored for varying periods up to 29 days in 90-pound bales left on the ground, one series screened with burlap and one fully exposed to sun and wind; neither series received any water except from infrequent rains. When the bales were opened, the top one-tenth to one-third of the seedlings in those left on the ground for 16 to 28 days were dry ; these dry seedlings were discarded without testing. The lowest survival of moist seedlings from such bales was 61 percent ; the next lowest, 77 percent ; moist seedlings from several bales, including one bale unsheltered for 29 days, survived better than 90 percent. In a supplementary study of longleaf stored for 3 weeks the bales were watered every few days; no seedlings were lost through drying and initial survival was 99 percent.

4. Even 1 to 3 days storage in water in tubs appeared to reduce survival significantly below that of heel-in or bale storage, and longer storage in tubs was fatal. In one study, average survivals (longleaf and slash pine combined) were : Fresh check, 68 percent; 1 day in tub, 53 percent ; 3 days, 51; 7 days, 15; 14 days, 4; 21 days, 2; and 28 days, 1 percent.

Less conclusive but still noteworthy results of the 1934-35 through 1940-41 storage studies were :

a. Cold storage at 35° to 41° F., in small sphagnum and burlap bales, gave erratic results, especially for periods of 3 to 13 weeks. Such storage was not so thoroughly tried as other methods, or in direct comparison with them, but seemed less reliable, as well as less convenient and more expensive.

b. Rather thorough testing in two different years showed no consistent ill effects from "double-heeling"—that is, from dividing storage between nursery heel-in and planting-site heel-in instead of heeling-in the stock in one place only for the entire period. This is reassuring, as much stock naturally has to be heeled-in at the nursery and again at the planting site.

c. There was a distinct tendency for stock that had been heeled-in for 2 to 4 weeks to survive better than stock heeled-in for only 1 to 3 days, or than unstored checks. In a few instances the superiority was very significant. To a less extent, the same tendency was apparent in stock stored 2 to 4 weeks, under favorable conditions, in bales. This finding is consistent with the good survival often obtained with nursery stock accumulated in the heel-in for 2 or 3 weeks before the shipping season. It also lends weight to the theory that prompt formation of new root tissue after planting improves survival (p. 123) . (Since seedlings lifted during a period of active root growth (fig. 24) may be expected to start callusing over the primed tips if not actually to form new roots at the point of pruning during 2 to 4 weeks' favorable storage, they presumably have a head start, in this respect, over unstored, freshly pruned lots.) The finding also supports the suggestion that root pruning in the seed beds shortly before lifting (p. 132) may improve initial survival. Improving average survival by systematically heeling-in all stock for 3 weeks before planting should not, however, be attempted commercially until success has been confirmed by exacting tests.

These storage studies included no tests of incomplete covering of the roots in the heel-in beds. It was felt that the harmfulness of such exposure was sufficiently proved by the root-exposure studies, and by depth-of-planting studies described later (p. 137) .

Although the studies were carried out in the lower South, on cut-over longleaf land, with longleaf and slash seedlings only, the findings should apply generally to all southern pines and throughout the southern pine region. In the northern part, however, care must be taken to keep seedlings from freezing in bales (8).

Root Exposure

Some exposure of seedling roots to sun or wind at the nursery during lifting and packing, and in the field during distribution and planting, is unavoidable. Such exposure is never beneficial, but the emphatic warnings against even momentary exposure which appear in many popular planting leaflets exaggerate its harmfulness to southern pine seedlings and have occasionally led to unnecessary and costly culling of good stock. So long as reasonable precautions are observed, there is little reason why short exposure during either lifting or planting should seriously reduce initial survival.

In Louisiana, exposure of longleaf and slash pine seedling roots was tested under various combinations of sunlight, temperature, and wind, in January or early February of three different years. In these three studies, exposures up to 10 or 20 minutes had little significant or consistent effect on survival. In one study, all exposures up to and

including 20 minutes, regardless of degree of sunniness, gave reasonably satisfactory survivals (range, 90 to 62 percent). Beyond 20 minutes, however, survival of both species decreased seriously and fairly regularly with each successively longer period of exposure, particularly on sunny days, and exposure for 5 hours and 20 minutes on a sunny day reduced survival to 6 percent. In another study, slash and longleaf seedlings, the roots of which were exposed for 2 hours to full sun and a gentle wind on January 31, survived 48 and 67 percent; comparable unexposed checks survived 98 and 99 percent. Cummings (009), who exposed the roots of 1-0 shortleaf pine seedlings for 0 to 135 minutes on a late April day, in Indiana, got a strong, smooth curve of first-year survival running from about 93 percent for 0-minute exposure to about 20 percent for 135-minute exposure.

From the results of these studies, it is recommended that : (1) Effort be made to prevent the exposure of any roots to wind and sun for more than 10 minutes, especially on warm, windy, or sunny days ; (2) exposure of roots be kept as much below 10 minutes as economical handling permits ; (3) masses or piles of stock not be thrown away, even if accidentally exposed for an hour or two, provided the seedlings are to be planted on the operator's own land ; but (4) when stock from exposed piles or masses is being shipped, especially in small lots, all seedlings with visibly dry roots be culled before rewetting and packing the stock. Recommendations (3) and (4) are based on observations that, in exposed piles or masses, the seedlings on top (although they themselves dry out) shelter the roots of the seedlings beneath, and that seedlings that have dried on the top of the pile can be recognized (118, 209) and removed only if they have not been rewet after exposure.

Planting trays.—To prevent exposure of the roots during hand planting, most planters carry southern pine seedlings either in 10- or 12-quart galvanized iron water pails, or, on jobs large enough to justify special equipment, in Ehrhart trays (figs. 36 and 37, *B*). In pails, the roots are kept wet either by water or puddling mud, or by wet moss. In Ehrhart trays, they are kept moist by a layer of wet moss beneath and a piece of wet burlap lying under the moss and extending up over the seedling roots and part of the tops. The chief advantage of the trays is that they permit carrying the seedlings flat and lifting out each seedling with minimum breakage of lateral roots. With reasonable care, many other receptacles give good results (718, 750). Planting machines come equipped with special seedling receptacles or racks for standard containers. Seedlings in any type of receptacle usually require additional water at intervals of an hour or less.

Puddling.—This consists of coating the roots of seedlings with thin mud, about like medium-thick pea soup, before planting them. It can be done by dipping the roots in the mud and then carrying the trees in a tray of wet sphagnum moss, but is more

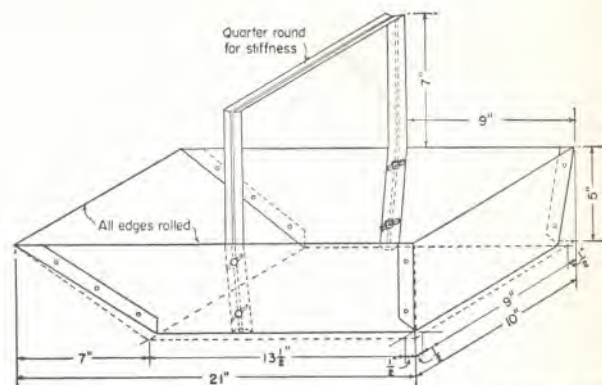

FIGURE 36.—Improved Ehrhart planting tray, made of 24-gage galvanized sheet steel and modified as suggested by Kellogg (367), used by Region 8 of U. S. Forest Service.

often done by carrying the trees upright in a pail of the puddling mud. When moss is unavailable, the mud does perhaps keep the roots more uniformly moist than does plain water. Puddling makes the trees unpleasant to handle, however, and means carrying more weight. Since it involves an extra operation, it adds to costs.

Planting instructions and circulars contain many contradictory and some extreme statements about puddling. Some pronounce it essential. Some say it kills the seedlings, a few attributing death to "chafing off of the root hairs" (p. 83) by the puddling mud. In studies on the Johnson Tract in two different years, puddling of two species in sharp quartz sand, in subsoil clay, in a mixture of sand and clay, in fertile topsoil, and in a sand-clay mixture inoculated with chopped mycorrhizal rootlets, increased survival significantly in only one minor instance, and decreased it significantly in none. In practice, puddling still is widely used in farm planting, but seldom in large-scale operations. Since unpuddled seedlings survive satisfactorily, puddling is judged unnecessary, except possibly where moss cannot be obtained to keep the roots moist during planting.

Mechanical Injuries During Planting

Except for breakage of lateral roots, which has already been discussed, mechanical injuries to seedlings during planting (including damage by workmen walking carelessly over newly planted areas and by the packing wheels of planting machines) consist mostly of : (1) Stem-bending, (2) crushing, (3) bark-scraping, (4) root-scraping, and (5) splitting of main roots.

Repeated tests have shown that these five types of injury reduce initial survival very little. In rigorous studies, even stepping hard on every tree immediately after planting did not significantly reduce the initial survival of either longleaf or slash pine. Moreover, in routine planting, all such injuries are relatively infrequent.

Two studies on the Johnson Tract in different years demonstrated clearly, however, that a combination of two or more types of injury, each negligible in itself, was likely to cause a serious reduction in initial survival. This was as true of minor mechanical injuries as of serious root exposure, loss of laterals, or certain serious errors in planting discussed later. The results of these studies are a strong argument against taking chances with any form of injury in either nursery or field, lest the effect of an avoidable injury aggravate the effect of a later unavoidable one.

Special Conditioning of Stock

When initial survival is low despite correct application of established nursery and planting practices, the question naturally arises as to whether some special treatment of the stock before it leaves the nursery would improve results. Although none has been developed to the point of commercial application in the South, five such special treatments deserve mention. They are : (1) Root pruning in the seedbed, with a period of growth between pruning and lifting; (2) fertilization between the end of the growing season and lifting; (3) use of foliage coatings to reduce transpiration immediately after planting; (4) needle pruning to reduce transpiration immediately after planting; and (5) root inoculation or treatment of the seedlings with growth-promoting substances or other chemicals to improve root formation after planting.

Root pruning in place, an appreciable time before lifting, offers some promise of success (306, 682). The feasibility of so pruning southern pine seedlings, by means of a special blade on the mechanical lifter, has been demonstrated for all but very heavy nursery soils. June, July, or August root pruning of slash, longleaf, and shortleaf seedlings has produced no substantial benefits (345), but theoretical considerations (fig. 24) (152) and the results of one preliminary study suggest that more benefit may result from late-season than from summer root pruning in place. Root pruning at 6 to 7 inches, 4 to 8 weeks before scheduled lifting, with undercutting at 10 to 11 inches at lifting time, seems worthy of small-scale trial. Dangling laterals of seedlings would still require pruning to 7 or 8 inches at the grading table.

Although excessive late-season fertilization, especially with nitrogen, seems to produce succulent stock that survives poorly, light to moderate applications of mineral nutrients from September or October to 5 weeks before lifting give promise of increasing initial plantation survival. Preliminary studies suggest that, for such late applications, fertilizers with a high ratio of potash to nitrogen are most likely to be beneficial. Such treatments are worth small-scale trial, particularly in nurseries the stock from which survives poorly, or for the production of stock for unusually adverse sites.

Some fungicidal foliage coatings increase transpiration; others decrease it (258, 336, 337). An otherwise unsuccessful rabbit-repellent spray has been found to increase initial survival of planted slash pine, and the initial survival of planted longleaf has been significantly altered by varying the sticker applied with bordeaux mixture at lifting time. Presumably these sprays affected survival through their effects on transpiration. Foliage sprays or dips to increase initial survival by reducing transpiration immediately after planting have been developed commercially (270, 708), and are used in transplanting ornamentals (479). Applications of some sprays to forest tree seedlings for this purpose have been ineffective or harmful (302, 646). S/V Ceremul C, however, is reported to have increased initial survival of planted ponderosa pine (708), and both lanolin-monoethanolamine stearate and commercial Do-wax have been reported to reduce transpiration and increase survival of planted loblolly, longleaf, and other pines (479, 552). Further testing of foliage coatings for southern pine seedlings is justified, especially where the stock must be planted in areas of low winter or early spring rainfall (fig. 4) or on excessively droughty sites.

Because most of the foliage of longleaf seedlings may be cut off with a mowing machine without injuring stems or buds, it is frequently proposed that it be pruned just before lifting, to reduce transpiration and increase initial survival, especially on dry sites. Several large-scale tests of close pruning of the needles have resulted in lower survival of pruned than of unpruned longleaf seedlings. In two experiments, complete defoliation of both longleaf and slash seedlings at or before lifting time has significantly reduced survival, and the more seriously the earlier the pruning was done, up to 12 weeks before lifting. Removing *half* of the total number of needles, however, up to 12 weeks before lifting, either did not affect the survival of longleaf and slash seedlings, or improved it. Several small unpublished studies (including one by Bailey Sleeth, Bureau of Plant Industry, Soils, and Agricultural Engineering) suggest that cutting off only the outer parts, up to three-fourths, of all longleaf needles, instead of whole needles as in the earlier tests, may similarly increase initial survival.

Various concentrations of indoleacetic acid, indolebutyric acid, naphthaleneacetic acid, and related growth-promoting substances applied to the roots or tops of southern and other pines in a number of studies have in general failed to improve survival, and in several instances have reduced it (62, 261, 474, 552, 768). Plank has reported improved survival of planted slash pine seedlings as a result of treating the roots with indolebutyric acid (576), but a Chi-square analysis of his published data shows that, because of the small numbers of seedlings tested, the improvement can hardly be considered significant. In two rigorous studies on the Johnson Tract, in differ-

ent years, no significant changes in the survival of slash or longleaf pine seedlings were produced by treating the roots with commercial preparations of indolebutyric acid, or with potassium permanganate solution or dilute sodium nitrate solution, or by puddling the roots in mud containing chopped mycorrhizal rootlets. In one of the studies and in an earlier study the application of commercial fertilizers in the puddling mud or in a flour paste, even at such low rates as 0.6 gram of 6-10-7 fertilizer per tree, killed 66 to 99 percent of the seedlings within 48 hours after planting.

PLANTING METHODS

In choosing planting practices for local conditions, the planter should keep three general rules in mind.

First, practices and techniques should be accepted or modified only to the extent that their influence on initial survival permits. Some, like depth at which the seedling is set, affect survival directly and significantly ; these permit little range of choice or modification. Others affect survival very little ; tools for hand planting, for example, may be chosen primarily to keep costs low rather than for their effects on survival.

Second, in choosing or modifying practices and techniques, the planter should realize that some are much easier to control than others. In hand planting, for instance, he can control depth of setting almost perfectly, but in machine planting control of depth is difficult.

Third, in cases of doubt about the effects of planting methods and techniques on initial survival, their probable effects on the water intake and water losses of the planted seedlings should always be considered (p. 123).

Hand Versus Machine Planting

Before World War II, all commercial planting of bare-rooted southern pine nursery seedlings was with hand tools. Hand tools must still be used on many eroded, steep, rocky, brushy, or partly stocked sites, and may always be more economical than machines for small-scale planting under certain conditions. On vast acreages, however, especially of cutover longleaf pine land and of abandoned but unguilted old fields, machine planting is feasible and is likely to be cheaper than hand planting. In Florida, for example, about 6 million acres, or 85 percent of the total plantable area in 7 forest types, has been reported as plantable by machine (445, 446, 447, 448).

Advances in design have made machine planting practicable in the southern pine region only since 1946. Since new machines are constantly being developed, it is inadvisable to attempt a discussion of machines and their operation here; details should be obtained from the rapidly growing literature on the subject (113, 219, 235, 245, 301, 335, 339, 361, 374, 375, 376, 674, 695, 719,

720, and later publications) . Machine-made holes or slits in which trees may be planted by men on foot (579, 769) are another means of reducing planting costs.

Exhaustive studies of hand planting give every reason to expect as good survival from machine planting, provided that the machine used is adapted to the site in question (674) and the seedlings are set at the correct depth. The initial and fourth-year survivals of slash and longleaf pines in the earliest recorded test of machine planting in the South (249), with machines now outmoded (674, 718), were comparable to those of hand-planted checks. In later studies, machine planting has resulted in nearly as good survival as hand planting, and sometimes better (25, 301, 536, 674) . The chief obstacle to high survival in machine planting usually is the difficulty of setting the seedlings at the right depth (p. 137) . Most planters allow for losses from this cause by planting one or two hundred more trees per acre by machine than by hand ; the saving effected by machine planting more than offsets the cost of the extra trees.

Ball planting (p. 22), under certain ideal conditions an alternative to planting bare-rooted nursery stock, ordinarily results in very high survival.

Rates of planting by different methods are discussed on page 146.

Choice of Hand Tool

Survival studies have shown conclusively that the hand tool for planting southern pines may safely be chosen on the basis of labor efficiency. Systematic time studies and general experience have shown that, under most southern conditions, a wedge-bladed metal bar weighing about 10 pounds is the most efficient tool. In particular, studies of more than 4,000 trees planted on cutover longleaf land during 1924-25 through 1935-36 showed that mattocks gave no better survival than bars, if as good, and were much slower ; later tests (249) have confirmed these results. By far the greatest part of all southern pine nursery stock has been planted in slits made with bars (fig. 37). So far as is now known, mattocks, posthole diggers, or special planting tools need be substituted for planting bars only on certain stony, badly eroded, or very heavily vegetated sites on the borders of the southern pine region and in limited localities within it (161, 010,277, 321, 421, 449, 488, 513).

Apprehensions concerning adverse effects of slit planting on later survival and growth (391, 617, 618, 628, 785) seem unwarranted so far as bar-planted southern pines are concerned. Excavations of roots, and the evident vigor and thrift of thousands of acres of plantations already yielding pulpwood and naval stores, argue against any great lurking danger from bar planting these species.



F-225991, 463681

Two models of the planting bar, developed from earlier models with less satisfactory **D** handles and often without steps, have been in general use since about 1936. They are manufactured commercially (fig. 38) with an offset attachment of handle to blade, the patent on which is held by the Council Tool Co. Their essential features, in addition to rigidity, strength, and an optimum weight of 10 pounds, are a blade 10 inches long, 3 to 3½ inches wide, three-fourths of an inch thick at the upper end, with high-quality steel edge (square or rounded as preferred) and smooth finish; adequate but not unduly protruding grip and step; and convenient length. For planting in pairs, most workmen prefer T-handled bars 42 inches long; very tall workmen prefer 45-inch bars. For planting by each man independently, 42-inch T-handled bars are reasonably satisfactory, but 36-inch T-handled bars are better and 38-inch half-Z-handled bars are best. Despite published information (718, 746) to the contrary, the open end of the half-Z handle should be on the same side of the bar as the step, as in figs. 37, **B** and 38, to avoid snagging the planter's clothes.

A steel dibble, 17 inches over all, with a pistol grip, and weighing 5 pounds (277) is excellent for planting by men carrying and setting their own trees in heavy brush on deep, coarse sands. It is

inferior to a bar on heavier soils and more open sites, and has not come into general use. On most sites a shovel or any other tool that will make a slit permits planting nursery stock with good survival, although with less efficiency than does a bar.

On sites too stony or hard for bar planting, or when bars are unavailable, mattocks or grub hoes generally are used for planting southern pines. The chopping blade of the mattock seldom is needed, and a grub hoe with a 4-pound head and a blade 9 or 10 inches long is about right for most conditions. Most mattock or grub-hoe blades curve too much toward the handle for easiest planting, and can advantageously be straightened until the cutting edge comes only one-half inch above a level surface on which the rim of the eye lies flat. A grub hoe designed especially for tree planting is described in *Forestry News* (30).

For ball planting, one useful tool is the Council special seedling lifter and transplanter.⁴⁹ This tool (718, p. 470) consists of a slit steel cylinder, mounted on a handle with a T-grip and a treadle. The cylinder is forced into the ground and contracted with the treadle. The tool is then withdrawn with a plug of soil about 5 inches in di-

⁴⁹ Manufactured by the Council Tool Co., Wanaleski, N. C.

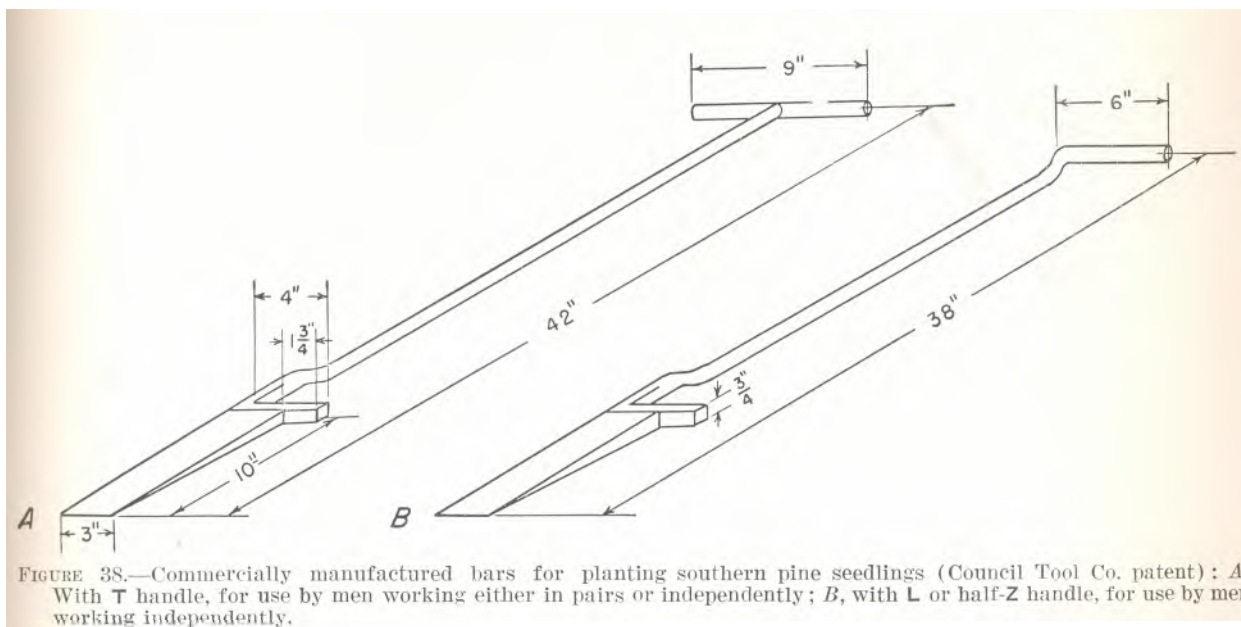

ameter and 6 inches long, weighing from 4 to 8 pounds. The tool works best in soil neither very heavy nor very light, and moist enough so that the plug holds together when released from the cylinder. Horton (338) describes and illustrates an ordinary square-pointed, short-handled garden spade with the two halves of a round-pointed shovel welded to the sides of its blade for similar ball planting.

Planting With Bar or Mattock

Debated alternatives in bar planting have included: (a) Setting the tree upright by the standard method (p. 228) versus making the planting slit at a 45° angle and closing it by stepping on it; (b) in the standard method, setting the tree in the center of the slit, or in the corner (which is alleged to give better control of depth of setting) and (c) planting with men working in pairs or with each man working independently and carrying and setting his own trees. Slant planting has been advocated as economical, and opposed as likely to cause serious mortality and to deform the roots of surviving trees; Munch's results in Europe, however, seem to refute the latter arguments (529). Small-scale tests of slant planting made with red pine in lower Michigan on sand plains gave poorer survival than the conventional bar-slit planting. Setting the seedling in the corner of the slit has been advocated as making planting more rapid and uniform, and opposed (without evidence) as reducing survival and distorting the roots of the survivors.

In mattock planting the debatable alternatives have been center-hole, side-hole, and slit planting (pp. 228-231), of which center-hole is the slowest and slit planting the fastest. Center-hole planting permits spreading the roots well, and has been both advocated and condemned because it leaves

the roots in contact only with soil which has been loosened in preparing the hole; one school of thought considers side-hole and slit planting better than center hole because they leave the roots at least partly in contact with soil in which undisturbed structure still permits capillary movement of water. Mattock-slit planting, however, like bar planting, is charged with killing or injuring trees by compressing their roots in one plane.

In two rigorous studies on the Johnson Tract, in different years, all these variations of bar and mattock planting were tested, with both slash and longleaf pine. The average initial survival did not differ markedly from tool to tool, nor was there any marked superiority or inferiority of initial survival from method to method of using either tool. Although the point has not been checked by excavating roots, none of the methods of using either tool has produced any discernible signs of abnormal growth or of lack of windfirmness during the first 10 years after planting. Negligible differences in initial survivals following center-hole and side-hole mattock planting of loblolly and shortleaf pine in the Georgia Piedmont have been reported (321). Evidently the method of using the tool, as well as the tool itself, may safely be chosen for maximum labor efficiency rather than for its effect on initial survival. The most efficient, in the vast majority of cases, is bar planting with each man carrying and setting his own trees.

Opening and Closing the Slit in Bar Planting

Failure to close the top of the planting slit greatly reduces initial survival. Except for wrong depth of setting (discussed later) it is likely to be the most frequent and serious error committed in bar planting. The importance of other

errors in opening and closing the slit have been somewhat overemphasized (748, 750, 752). Both rigorous studies and the good survival obtained in much routine planting have shown that most of these errors cannot possibly affect initial survival as adversely as was formerly thought, and that extreme care to avoid them may greatly increase costs without improving results.

Serious decreases in initial survival have been attributed to: (a) Opening the planting slit too widely (making "hour-glass-shaped" slits, alleged to prevent proper closure and to leave fatal air-spaces around the roots); (b) allowing leaves, grass, and other trash to get into the planting slit; (c) closing the planting slit without straightening out the seedling roots ("planting with U-roots," popularly but erroneously believed to be the principal cause of plantation mortality); (d) failure to close the bottom of the planting slit completely; (e) failure to close the top of the planting slit completely; and (f) making the closing slit too close to the planting slit or failing to fill the closing slit by means of a second closing slit or a thrust with the heel.

The effect of each of these "errors" in bar-planting technique, except (b), was tested on the initial survival of longleaf and slash pine on the Johnson Tract, in from one to three studies apiece. Results of "incorrect" planting were compared with those of correct, standard two-man-crew bar planting, with a single closing slit about 3 1/2 inches behind the planting slit and the closing slit in turn closed with the heel. The soils on which these tests were made were moderately stiff, especially at the bottoms of the slits, and therefore might be expected to accentuate any adverse effects of improper planting (628). In all treatments the seedlings were set at the same depth as that in which they had grown in the nursery. Table 25 summarizes the initial survivals resulting from the different types of faulty planting and from correct planting of checks in two of these studies, in different planting seasons. In a study in 1934-35, slash pine survived 69 percent when planted with U-roots; 65 percent when no closing slit was used, the top of the planting slit was closed with the heel, and the bottom was left unclosed; and 62 percent with standard bar planting. With longleaf in the same study, each of these 3 treatments resulted in 86 percent survival. In these three studies contrasts among treatments are valid only within each planting season.

Despite some inconsistencies, particularly in the 1935-36 study, these results show several important things.

1. Exaggerated or "hour-glass" opening of the planting slit by excessively working the bar handle back and forth, although it wastes time and effort, is an unimportant cause of poor initial survival.

2. Planting with U-roots, far from causing certain death as has sometimes been charged, usually has a negligible effect on initial survival. In these studies, it gave survival about as good as or better

than the average survival of comparable checks in five cases out of six. This is not to condone planting with U-roots, or to deny that such planting may later increase windthrow (p. 149), but it does suggest looking for more likely causes when survival is poor. It is not illogical to assume that U-root planting may sometimes slightly increase survival by keeping all roots in contact with the best topsoil. Rudolf similarly reports little reduction in survival from U-root planting in the Lake States, and notes that the greatest amount of moisture, over a 7-year period, was in the top 6 inches of soil (617, 618).

TABLE 25.—Effects of slit opening, root placement, and slit closure on initial survival of bar-planted southern pines

Treatment ¹	Survival in 1935-36 study		Survival in 1936-37 study	
	Slash pine	Long-leaf pine	Slash pine	Long-leaf pine
Standard 2-man-crew bar planting	Per-cent ² 71	Per-cent ³ 42	Per-cent 96	Per-cent 82
"Hour-glass" (excessively opened) slit, but well closed with bar and heel	73	42	87	89
U-roots ⁴ in normal slit	56	42	94	88
Closing slit within 1 inch of planting slit; heel not used	70	38	89	81
Slit closed at top only, with bar; heel not used	68	51	86	51
Slit closed at bottom only, with bar; heel not used	76	21	57	35

¹ Roots normally placed in slit in all treatments except specific test of U-roots.

² Average of 3 check treatments surviving 63, 78, and 71 percent.

³ Average of 3 check treatments surviving 39, 54, and 34 percent.

⁴ Roots doubled in the middle and left with the pruned ends pointing upward after planting, though not projecting above ground.

3. The relatively high survival of all four lots of seedlings planted with a closing slit only 1 inch from the planting slit, and without filling this closing slit by forcing earth in with the heel, shows that a *second* closing slit is an unnecessary refinement. In bar planting at 6- by 6-foot spacing, making a second closing slit requires at least 2,400 waste motions per acre.

4. Incomplete closing of the bottom of the planting slit, although in the 1936-37 study it decreased survival of both species and especially of longleaf pine below that for four other treatments, did not decrease survival significantly in the other two studies. These results have important bearings on both hand and machine planting. They show that no time-consuming special pre-

cautions need be taken to close the bottom of the planting slit in bar or mattock planting ; following the directions on pages 227 to 231 insures sufficient closure. They also show that very firm packing of the soil against the bottom of the root system is not essential to successful machine planting. In the earliest test of machine planting in the South it was noted that the machine packed the earth less firmly than did hand tools, yet machine planting gave fully as good survival (249). Modern machines, although sometimes criticized for insufficiently firm packing, have also given as good survival as hand tools.

5. Failure to close the *top* of the planting slit reduced very significantly the average survival (both species combined), in both years this faulty technique was tested, even though slash pine survived it fairly well in 1935-36. With longleaf pine, leaving the top of the planting slit open caused near failure in 1936-37 and failure in 1935-36. In the 1935-36 study it was the only fault which reduced average survival (both species combined) below the range of similar average survivals of check lots planted correctly and exactly alike (table 25, footnotes 2 and 3). In the 1936-37 study it again resulted in much lower survival than any other fault. Unlike the others, therefore, it must be counted a serious error. By the same token, a planting machine that fails to close the soil firmly against the *top* of the seedling roots must be regarded with suspicion.

Reexamination of the trees in the 1935-36 study 4 1/2 growing seasons after planting showed that longleaf pine survivals had decreased below those in table 25 by from 4 to 9 percent, and slash pine survivals by from 2 to 13 percent. There was no consistent relationship between decrease in survival and error in planting technique, and nothing to indicate any serious effect on survival after the first year as a result of any of the planting faults studied. It should be remembered, however, that the faults other than the failure to close the top of the planting slit might still affect survival after the first 5 years in plantation, or reduce windfirmness, or cause root infection (325, 616, 617, 618). These errors in planting technique should therefore be avoided as far as possible without increasing the cost of planting.

Depth of Setting

In ordinarily well-conducted planting operations, *setting southern pine seedlings at the wrong depth probably reduces initial survival more often and more seriously than any and all other errors in planting technique combined.*

Seedlings should be planted at the same depth as that at which they grew in the nursery—that is, with the nursery ground line at the surface of the soil of the planting site. (With all southern pine seedlings except longleaf, a distinct change in color, from dull green above ground to yellow

brown below ground, marks the position of the root collar or nursery ground line ; with longleaf, the under side of the lowest needles may be taken as the ground line.) The surface around the newly planted tree should form neither a mound nor a hole (513), especially in bare, freshly burned, or easily eroded surfaces. One of the chief disadvantages of furrowing as a means of site preparation is that furrows are likely either to wash out or fill in after the trees have been planted.

If seedlings cannot be planted at exactly the same depth, planting them a fraction of an inch deeper than they stood in the nursery is preferable to setting them too high ; some authorities say one-fourth of an inch deeper (513), or up to 1 inch in special cases (210). Overdeep setting in general is thought to increase root and root-collar infection (302). The practice of setting longleaf seedlings approximately one-half inch *higher* than they grew in the nursery to prevent silting (718, 748, 750, 752) generally does more harm than good, and should be abandoned.

These recommendations are supported by wide experience with all species and by experiments with both longleaf and slash pine, in each of two different years, on the Johnson Tract. In these studies there were few significant differences among the initial survivals of seedlings set at nursery depth or deeper, but almost without exception, the initial survival of seedlings set one-half inch too high, or higher, was significantly or very significantly reduced (table 26). (Except for higher mortality among seedlings set more than 1 inch deep, a subsequent study of both hand- and machine-planted trees confirmed exactly the relationships shown for longleaf in table 26 (674).)

TABLE 26. *Effect of depth of setting on first-year survival of bar-planted southern pines*

Seedling treatment ¹	Survival in 1935-36 study		Survival in 1936-37 study	
	Slash pine	Long-leaf pine	Slash pine	Long-leaf pine
Set deeper than they grew in the nursery, by—				
2 inches	83	80	95	82
1½ inches	80	70	98	83
1 inch	80	82	96	95
½ inch	81	83	96	90
Check: set at same depth as in nursery	83	73	92	74
Set higher than they grew in the nursery, by—				
½ inch	58	44	91	59
1 inch	35	34	78	56
1½ inches	23	10	56	40
2 inches	26	7	59	30

¹ Root systems pruned uniformly to 7½ inches before planting; planting slits closed in normal manner.

The high initial survival of some of the deeply set seedlings must be accepted with reservations, because of the possibility of a delayed adverse effect of deep setting, particularly of longleaf pine. The bad effects of setting seedlings too high are beyond question. With most lots of seedlings set more than 1 inch too high, these effects amounted to plantation failure. In these and parallel experiments, slight differences in depth of setting produced far greater differences in initial survival than any details of bar planting except failure to close the top of the planting slit (table 25).

It is thought that the main cause of mortality in high setting is loss of water through exposed root tissue. This seems a more likely explanation than insufficient depth of root tips. In the two studies just described, for example, the seedlings were root-pruned to 7 1/2 inches. The four lots set 2 inches too high therefore had their root tips 5 1/2 inches below the soil surface. Their average initial survival was 30 percent. Essentially comparable stock was planted under parallel conditions in two studies of root pruning. Four lots of these seedlings root-pruned to 5 inches had their root tips one-half inch less far down than the four lots set 2 inches too high, but, being set with their root collars at ground level, had no root tissue exposed, and had an average initial survival of 56 percent.

Since depth of setting has these important effects on survival and the greatest single difficulty in correct machine planting has been in setting the seedlings at the right depth, efforts to improve both design and operation of planting machines should be concentrated on setting the seedlings at the depth at which they grew in the nursery, or (table 26) *slightly* too deep rather than too high.

Skill of Individual Planter

Lack of planting skill, although it undoubtedly reduces initial survival in many cases, is far less of an obstacle to success than is often assumed. In the first place, the blank or nearly blank rows frequently attributed to poor planting by individual workmen are as likely to have resulted from injury to particular bundles of stock during lifting or storage, or from the depredations of a hog or rabbit traveling systematically down a row. Secondly, individual deficiencies in planting ability can almost invariably be overcome by training and supervision.

Two experiments on the Johnson Tract, in different years, revealed no significant differences in the survival of longleaf and slash seedlings planted by different men who had been equally well trained in correct planting (p. 227). It was also found, in studies of the effects of faulty planting upon survival, that it is hard for well-trained, experienced men to plant incorrectly even if they want to.

Fertilizing the Planting Spot

There has been much speculation about the desirability of fertilizing the planting spot, but few reports of its effects on initial survival, particularly of southern pines, have been published. McQuilkin has reported decreased frost heaving, but also increased weed growth and decreased survival of planted red pine (especially of small seedlings) as a result of fertilizing planting spots (471). Others have noted reduced survival of shortleaf and other pines (either from increased competition by weeds or from direct injury by the fertilizer) without attendant reduction in frost heaving (207,332, 790). The closing slit in standard bar planting offers an easy method of fertilizing the individual tree, but even this involves considerable expense for fertilizer and labor, and should not be tried on a large scale until thorough testing has shown benefits in proposition to costs.

Even if it increased initial survival significantly, fertilization sufficient to increase early growth of planted loblolly and slash pines probably should be avoided in zones of serious fusiform-rust infection (p. 160).

Control of Spacing

In most planting in the southern pine region, control of the spacing chosen (pp. 18-22) should not be maintained so closely as to increase greatly the cost of planting, but merely well enough to avoid wasting growing space or overcrowding the planted trees. Exceptions are demonstration and experimental plantations, in which precise spacing and alignment are desirable or essential, and plantations in brush or on eroded land, in which control of spacing must be worked out to fit local circumstances.

In hand planting on unprepared or on burned sites, some planters rely entirely on the skill of the workmen to keep rows reasonably straight and uniformly spaced. Others maintain the direction and width of the planting strip more exactly by lining up flags in front of both the first and the last man in the planting line, leaving the men between to space their rows by eye. Crews of 12 to 20 men (the number increasing with the skill of the men and the openness of the site) can plant at satisfactorily uniform spacing with two rows of flags. On the less brushy sites, it has been found possible to keep almost equally good spacing by using only one line of flags, set to mark the new row next to the last one planted on the preceding strip. When the site is prepared by furrowing, flags are seldom needed, as each successive furrow is spaced by eye, with occasional check measurements, from the preceding one. When spots are scalped in advance of planting, the flags are used by crews preparing the spots. On unprepared sites, some planters have their crews plant

abreast. Region 8 of the U. S. Forest Service has found it quicker to have the crew move down the strip at an angle of 45 degrees, the lead man planting on the flag line, and the man on each succeeding row planting one space farther back (736). The faster workers should always be at the forward end of the crew.

Regardless of the method of keeping the rows straight and well placed, the distance between trees within each row is kept by pacing, checked occasionally with a measuring stick. Trees in adjacent rows need not be directly opposite each other; location with respect to good or bad planting spots or already established seedlings is often better if they are not. An exception is planting in equilateral triangles (p. 22), in which control of spacing is maintained by planting trees squarely opposite each other in rows twice as far apart as the specified distance between rows. On the return trip the crew completes the triangles by planting a tree in the middle of each of the rectangles formed by the trees planted on the way out.

Where seedlings, saplings, or larger trees are already established, the specifications of Region 8 of the U. S. Forest Service for hand planting at 6 by 6 spacing are essentially as follows: (a) In approaching a pine seedling or small sapling already established on or within 3 feet of the row, plant the last spot before it if the spot falls more than 3 feet from the established pine; if it falls within 3 feet, do not plant; (b) in either case, plant the next seedling at a point 6 feet from the naturally established pine, but on line with previous planted seedlings; (c) plant no seedlings directly under the crowns of larger established pines; and (d) plant no seedlings directly under the crowns of undesirable hardwoods more than 15 feet high or 4 inches d. b. h. unless the hardwoods are to be girdled or removed.

In machine planting on relatively level ground, the rows should be made as straight as the presence and visibility of obstacles permit, both to keep spacing uniform and to minimize crushing of the seedlings by the packing wheels when the planting machine changes direction abruptly. On rolling or hilly ground, rows should follow the contour, approximately, to prevent soil wash (335). The tractor operator maintains the correct direction and spacing of rows by eye. The planter riding the machine usually depends on a sense of rhythm for correct spacing within the row, and except on rough ground a skillful man usually can set seedlings at least as regularly as a man on foot. Unlike the hand planter, however, he cannot skip places for established seedlings, since the machine prevents his seeing them in time.

Demonstration plantations, to catch the public eye and emphasize the desirability of planting, must not only survive and grow well and produce an economically attractive yield, but also "look like plantations" without the help of explanatory

signs. Rows must therefore be distinct in at least one direction, preferably at right angles to a road, and should be distinct in two. Such plantations are most conveniently spaced by means of wires or light chains, marked at proper spacing intervals with paint or bright rags; ropes are less desirable because they may link or stretch during planting.

Accurate spacing pays in experimental plantations because it permits finding the seedlings readily at reexamination time by measuring from stakes at the ends of rows, or from adjacent trees, and makes unnecessary the expensive staking of every tree. This is particularly true of longleaf planted in heavy grass. It has been found easiest and most economical to lay out plot boundaries with compass and steel tape, setting stakes opposite each other on two sides of each plot to mark both ends of each row of trees (758). The trees are then planted at bright paint marks at proper intervals on a cord stretched tightly between the two stakes marking each row. No trees are planted on the boundary, however, lest they later hide the corner Posts.

PLANTING AMONG PINES OR HARDWOODS

Except for planting on severely eroded sites, interplanting and underplanting are perhaps the most difficult and expensive operations the planter of southern pines has to face. Yet these means of bringing ragged natural stands⁴¹ of pine seedlings or saplings to full stocking and of converting low-value hardwood stands to pine are technically and economically feasible over large areas in many forest types.

Immense amounts of inter- and under-planting need to be done. The data summarized in table 1 (p. 1) suggest that 40 percent of the area most likely to be planted in the southern pine region will require one or the other of these procedures in some degree, and that on 30 percent, or about 4 million acres, the work is likely to involve complex technical problems. Later data indicate more than 1.7 million acres of scrub oak in need of planting in Florida alone (445, 446, 447). Ross, from a study in Randolph County, Ala., concludes that the need for stand conversion is particularly urgent on many farms if farm woodlands are to yield the financial returns they should (609). Other studies in Alabama have substantiated Ross' findings by showing that, on an average for four largely agricultural Alabama counties, pine was failing to reproduce in half the woodlands for lack of seed source and in a quarter of them because of competing hardwoods or of hardwoods and scanty

⁴¹ *Replanting or replacement planting to bring plantations with poor initial survival back to full stocking is discussed on pp. 164-168.*

seed source combined (119). Closely similar conditions exist in much of the Piedmont (79) and in parts of the Coastal Plain (fig. 39) from Maryland to Texas.

Planters in the South, as in the Lake States, have hitherto tended to plant the easy, open areas first, and, where they have underplanted brush, have too often made the erroneous assumption that "the overstory would protect the planted trees during early life, and then obligingly open up at the proper time and allow them to pass through and grow unmolested" (616). As a result, less explicit information is available than one might desire concerning interplanting, underplanting, and effective stand conversion in the southern pine region.

Planting Among Pines

Especially in the longleaf type, but in many areas of other types also (506), there are hundreds of thousands of acres with no seed source immediately in sight, with too few seedlings to make an operable stand, and with such large openings among established seedlings or saplings that many trees can be planted without fear of competition from established pines. Since seedlings planted in the openings will normally reach pulpwood size before the widely separated seedlings already established produce much seed, planting will gain at least a pulpwood rotation on whatever percentage of the area is now in openings (194). Although precise evidence is lacking concerning the *maximum* degree of stocking it pays

to increase by planting, and the *minimum* size of opening in which planted trees can escape serious competition from pines already established, the U. S. Forest Service standards for plantable areas and for planting next to established seedlings (pp. 121 and 139) may be helpful guides on these points.

The earlier in the life of the established seedlings and saplings such interplanting is done, the greater is the likelihood that the planted trees will escape serious competition, and the greater the financial returns are likely to be. Planted pines seem to survive less well next to pine saplings than next to oaks of the same size, particularly on sandy soils. This has been shown by slash pine planted among scattered longleaf 2 to 4 inches in diameter on light soils in Alabama. Openings in understocked old-field shortleaf pine stands apparently repay interplanting with shortleaf only if they are at least twice as wide as the height of the established trees among which they occur (511).

Interplanting one species with another may be advantageous for the insurance offered by mixed stands (p. 12). Slash pine (and, on sites favorable to it, loblolly pine) interplanted among young natural longleaf just starting height growth, has a better chance of keeping up with the natural seedlings than planted longleaf would have. Planted slash and loblolly may similarly keep pace with young natural shortleaf. In northeastern Florida (194) and even in the face of severe rust hazard at Bogalusa, La., slash pine has been interplanted extensively in young, under-



FIGURE 39.—Scrub oak stand (left) requiring conversion by planting to make the site as productive as that in properly managed natural longleaf pine (right). Both areas were logged in the same operation 25 years previously. Bogalusa, La.

stocked, natural longleaf stands to insure an earlier yield of pulpwood and a well distributed source of slash pine seed for future natural reproduction.

Pruning established trees during or after the interplanting of a sparse natural stand may appreciably increase the value of the products obtained from them (p. 171). Pruning the established trees severely enough to check their growth somewhat (p. 172) has been suggested as a means of improving the survival, growth, and form of the planted trees, but its effectiveness with southern pines remains to be demonstrated.

Planting Among Hardwoods

The conversion of low-valued hardwood stands by planting pines may be accomplished in several ways, dependent upon the character of hardwood stands. Where hardwood brush is open and offers little competition to the planted pines, planting can be straight through and release from the hardwoods may never be needed. Dense brush requires some form of broadcast control treatment, usually best applied before planting. Open stands of large-size hardwoods may be fairly well converted by planting only in the openings and leaving the hardwoods at least temporarily untreated. Dense stands of large hardwoods ordinarily will have to be opened up prior to planting by killing or removing the hardwoods individually ; if this cannot be done, the pines should be released as soon after planting as possible.

Whatever method is dictated by the condition and size of the hardwoods, the details are dependent upon the way the climate, the site, and the hardwoods themselves affect the survival and growth of the planted pines.

On dry sites with scanty or irregular rainfall, hardwoods are more likely to compete with the pines for water than for light ; partial shade cast by hardwoods may be beneficial to the pines at least during the first year after planting; and sudden removal of all shade from pines that have been growing under hardwoods for several years may seriously reduce survival (64, 228, 382, 387, 396, 418, 436, 470, 506, 510, 511, 513, 545, 616, 645). On moister sites, where growth of all vegetation is rank, the hardwoods may reduce survival and growth of underplanted pines mostly by cutting off the light (387, 389). Hardwoods sometimes kill longleaf seedlings that have not started height growth by smothering them under fallen leaves.

The sprouting habits of the competing hardwoods materially affect the details of stand conversion. Sprouting varies greatly with climate, site, species, and age or size of hardwood, and method and season of hardwood treatment (112, 106, 127, 130, 134, 420, 429, 673, 690, 698). As a rough general guide, less sprouting results from wide girdling and very much less results from poisoning with ammonium sulfamate than results from burning, pulling, cutting, or single girdling;

hardwoods larger than about 10 inches d. b. h. generally sprout much less vigorously than smaller ones ; and cutting or girdling southern oaks in the summer may reduce the number and vigor of the sprouts more than does girdling at other seasons.

As a rule, all the southern pines but longleaf make increasingly greater height growth each year for perhaps the first 5 years after planting or after release, and maintain their maximum rate of growth for the next 5 or 10 years thereafter. Even longleaf does the same once vigorous height growth has begun. By contrast, the growth rate of most hardwood sprouts is greatest for the first 1 or 2 years after they start. For these reasons, planted pines tall enough to stand level with the tops of sprouts at the end of the first growing season after release, and smaller pines not too close to the sprouts, have a good chance of overtopping the sprouts. Aided by relatively long periods of height growth each year and perhaps by their ability to elaborate and store food overwinter, when all but a few species of competing hardwoods are leafless, southern pines frequently are able to grow up through light to moderately heavy overtopping hardwood stands without release. Loblolly, slash, and shortleaf seedlings severely weakened by extreme competition with hardwoods before being released, and longleaf pine under any circumstances (because of its stemless juvenile habit and natural delay in starting height growth) are least likely to overtop hardwood sprouts or untreated hardwoods successfully (99, 344, 418, 478, 513, 747)

Cutting hardwoods back to the ground kills part of the roots (801). Killing back the hardwood tops by burning or girdling should have the same result, and poisoning the tops is believed to be still more effective in killing roots. Even though they permit the hardwoods to sprout, these treatments therefore probably make more soil moisture as well as more light available to the planted pines.

Planting in open brush.—Fewer than 500 5-foot sprouts per acre or fewer than 300 5- to 15-foot hardwoods per acre are a negligible obstacle to planting. On sites occupied by such small quantities of brush, about as many pines may be planted per acre as would be planted on open land. They may be planted at regular spacing or, preferably, with some adjustment of spacing to avoid setting pine seedlings within 1 foot of hardwoods less than 5 feet high, within 3 feet of hardwoods 5 to 15 feet high, or under the crowns of larger hardwoods. Machine planting is satisfactory if the equipment is heavy enough to get through the brush. Cutting, girdling, or poisoning of hardwoods at planting time or afterward usually is unnecessary, especially if spacing has been modified to avoid the hardwoods.

Broadcast treatment of competing brush.—Broadcast treatments are most applicable to dense stands of slender-stemmed plants like gallberry, waxmyrtle, or blackberries, or of young oak or

gum sprouts, but may be used with rank stands of palmetto and with oaks 3 to 4 inches in diameter. After treatment, planting is done at uniform spacing. Treatments include burning (p. 124) ; heavy furrowing (p. 124) ; spraying the brush with ammonium sulfamate or other herbicides ; and thorough chopping of the brush with heavy rollers armed with longitudinal blades. Chopping with rollers has been highly effective in reducing gallberry and palmetto, and even scrub oak up to 4 inches in diameter (698,795). Disking in advance of planting may similarly permit successful planting of pines in dense gallberry and palmetto (194).

A modification of burning when scrub oaks of any size are present is to cut the oaks in August, burn the cut oaks and new sprouts in August 1 year later, and plant during the winter following the fire (169). Repeated annual fires for several winters before planting may very greatly reduce oak brush of the smaller size classes ; they may do so, moreover, without eliminating all natural longleaf seedlings already partially occupying the site (122,166) .

Fire is a flexible tool. A single hot fire may be used before planting to kill back fairly large hardwood sprouts on areas on which there are few or no naturally established pine seedlings. Less

severe fires may be used to reduce brush, before planting, where it is desired to save established natural longleaf seedlings, or may be used to reduce brush in longleaf plantations 3, 2, or occasionally only 1 year after establishment, and even in established shortleaf stands in which the pines have reached 2 inches d. b. h. (141, 244, 430). Burning to control hardwoods without excessively injuring intermingled pines requires, however, much judgment, skill, and care (p. 163) .

Preempting openings.—On many sites occupied by hardwoods too large for broadcast treatment, the brush can be converted to operable pine stands by preempting all openings of about a hundred square feet or more (fig. 40) with planted pines and leaving the actual brush thickets unplanted (fig. 41) . The method is particularly appropriate where the very size of the operation rules out such intensive treatments as girdling or poisoning individual hardwoods. Its chief disadvantage is that, because of their small size and irregular shape, the openings must be planted by hand instead of by machine. The method is inapplicable where medium to large hardwoods occupy more than about 70 percent of the site.

Pines planted to preempt openings in brush should always be spaced as closely as safety from



F-465230

FIGURE 40.—Sunny, grassy, unquestionably plantable opening in interior of scrub oak stand shown in figure 39. The grass was heavy enough so that cattle had grazed it ; the surrounding scrub oaks were too dense to underplant without girdling or poisoning.



FIGURE 41.—Seven loblolly and slash pines surviving out of 9 planted 5 1/2 years previously, at close spacing, in minimum plantable opening in 10- to 20-foot-high oak and hickory brush at Talladega, Ala., by the Alabama Agricultural Experiment Station.

stagnation permits (pp. 18-22). Close spacing makes full use of the growing space not encumbered with brush and helps offset the loss of production on the unplanted brushy portions. At 5.5- by 5.5- or 5- by 6-foot spacing, for example, as many trees can be planted in the openings on an acre 47 percent open and 53 percent occupied by brush as can be planted at 8- by 8-foot spacing on an acre entirely free from brush, and plantable openings totalling only 30 percent of an acre will take more than 500 trees at 5- by 5-foot spacing.

Where most of the openings to be preempted are small, loblolly, slash, or shortleaf pines, because of their better early height growth, have a better chance of catching up to and crowding back the surrounding hardwoods than has longleaf. With this exception, species should be chosen for site as in any other planting, and on many dry sites where openings are large enough, longleaf may be the best choice.

Successful preemption of openings requires good local knowledge of how large an opening seedlings need to survive and grow well, and of how close to a wall of hardwoods pines can be planted effectively. Both these things vary widely from place to place. For example, Liming has shown that in the Missouri Ozarks planted shortleaf pine within 7 to 10 feet of unmodified oak stands may grow at only half the rate of seedlings 40 to 45 feet from the stands, and that measurable adverse effects of the hardwoods may extend outward for at least 25 or 30 feet (4/8). By contrast, on an area in Alabama covered with heavy hardwood brush 10 to 20 feet high, loblolly and slash seedlings planted under the edges of hardwood crowns but receiving full light from one side, grew fast enough to overtake the hardwoods (fig. 41), and Wahlenberg has reported aggressive growth of natural loblolly seedlings in Arkansas in openings only 15 feet in diameter (717).

For the central, Piedmont, and southern Appalachian regions, Minckler and Chapman recommend confining planting to openings where direct sunlight reaches the ground (fig. 40) and say that if its diameter is about twice the height of the surrounding trees the opening may be planted, usually without future cutting to free the planted pines (513). Through much of the longleaf type, planted seedlings of longleaf and especially of slash pine seem to survive and grow satisfactorily as close to scrub oaks as *Andropogon scoparius* and the commonly associated grasses are able to survive in moderate density (fig. 40), but, unless released, are likely to fail where the oaks have thinned out or killed the grass.

Planting should be limited to openings large enough to take four or more seedlings at the closest spacing acceptable for the species and site. Planting smaller openings is inefficient, and pines planted singly or in twos or threes seem to compete less successfully with surrounding hardwoods than do larger groups.

In many instances, preempting of openings will be most successful if done early. It is true that scrub oak stands open up with age, and it may be true that young vigorous hardwoods of no great height compete more severely with individual pine seedlings than do older hardwoods; data on this second point are scanty. Nevertheless, patches of hardwood are likely to become larger and openings smaller each year for many years. The hardwoods grow taller also, and become correspondingly harder for the planted pines to overtop. Therefore it may pay a planter with both brush-free and partly brushy tracts to use the former (which can be planted at any time) for grazing (145) until he has finished planting the latter, or at least to plant some of both classes each year, instead of planting all his brushless areas first.

Treatment of individual competing hardwoods.—Underplanting scrub oaks and associated hardwood species with southern pines at regular spacing and cutting, girdling, or poisoning the

hardwoods just before or soon after planting may often convert the hardwoods effectively to pine (figs. 42 and 43) even when the hardwoods are 20 feet high or 6 to 8 inches d. b. h. and shade 60 to 80 percent or more of the ground (121, 396, 418, 420, 467, 690, 800). Both planted and naturally reproduced southern pines benefit clearly, in survival and especially in growth, when free of or released from hardwood competition (33, 132, 134, 673, 747). Cutting, girdling in various ways, and poisoning are applicable to practically all competing species except palmetto and such slender-stemmed species as gallberry, which in open stands require no treatment and in dense stands are most economically and effectively treated broadcast.

Effective release by cutting or girdling the hardwoods need not be prohibitively expensive. Although increases in the growth of pines planted or naturally reproduced under hardwoods generally are greater the greater the degree of release (99, 127, 396, 418, 513, 690), it is by no means always necessary to cut or girdle all the hardwoods. Often only those hardwoods competing strongly with or actually overtopping the planted pines need be treated. McPherson treated such hardwoods on a representative brushy site at a cost of 1.7 man-hours per acre; Liming advocates reducing the basal area of overtopping hardwoods

to less than 27 square feet per acre; Stahelin suggests complete release where labor is abundant, hardwood can be sold for fuel, and pine can be sold for pulpwood, but only partial release where labor is scarce and sawlogs are to be the principal pine product (418, 467, 690). Combining release of planted pines with domestic or commercial utilization of scrub oaks or other competing hardwoods is sometimes an ideal solution of the problem; it should often be possible on farms (33, 800) and sometimes on larger holdings (207), especially with the increased use of hardwood for pulp (185). Planting of shortleaf pine following cutting of oaks for fuel, with subsequent cutting of sprouts, has been an established practice in New Jersey for more than 20 years (522).

With either cutting or girdling, average cost per tree increases with diameter of tree (175). Double-hack girdling (cutting into the sapwood and prying out the chips in a ring 3 inches wide) is most effective in killing hardwood tops and may reduce sprouting, but is considerably more expensive than single-hack or frill girdling. Special girdling tools (212, 213, 317, 416) may be more efficient than axes under some circumstances. Unless the pines to be released are very small, girdling usually is done knee to waist high to save expense. As a rule, it is most economical to cut



F-465232

FIGURE 42.—Loblolly and slash pines planted at regular spacing under dense, 10- to 20-foot-high oak and hickory brush near Talladega, Ala., and released $3\frac{1}{2}$ growing seasons after planting and 2 seasons before picture was taken.



FIGURE 43.—Slash pine planted at regular spacing under dense 12- to 15-foot-high hardwoods at Auburn, Ala., and released 4 years after planting and 81/2 years before picture was taken.

hardwoods less than 4 inches in diameter and to girdle those 4 inches in diameter and larger. The lingering shade cast by girdled trees does no harm and may reduce mortality from too sudden exposure of the pines, and damage to pines from falling tops of girdled hardwoods is negligible (132, 418).

The time at which competing hardwoods are cut or girdled often materially affects the success of stand conversion. Often the main difficulty in releasing planted southern pines is the impossibility of deciding whether cutting or girdling the hardwoods at any given time will actually let the pines outgrow the inevitable sprouts.

Underplanted slash and loblolly pines have responded to release by cutting or girdling the hardwoods from 2 to 3 or 4 years after planting, but have not always benefited from such release at time of planting. Shortleaf may repay release any time up to 10 years, but Liming recommends

Planting the Southern Pines

release at time of planting. Investigators of underplanting, stand conversion, and related problems near the borders of the southern pine region (99, 127, 161, 396, 417, 418, 420, 522, 545, 800) have in general recommended earlier release than have those in the interior portions of the region (33, 121, 132, 134, 382, 436, 467, 673, 690).

Correct timing of cutting and girdling to release planted longleaf pine is particularly difficult. If the hardwoods are cut or girdled before the longleaf has started active height growth, their sprouts are almost sure to overtop the longleaf; yet without treatment of the hardwoods the longleaf may never start, or even survive (690).

The simplest and surest way out of the time-of-release difficulty is to poison the hardwoods. Although poisoning may not kill all competing hardwoods and prevent all sprouting, it should, if correctly done, reduce both original hardwoods and new sprouts sufficiently to give the pines, including even longleaf, a permanent advantage, and to make the exact year of treatment less important than in the case of cutting or girdling. There is increasing evidence, however, that poisoning the hardwoods just before or immediately after planting is most beneficial to the pines.

Ammonium sulfamate (trade name, Ammate) and sodium arsenite have been found highly effective for poisoning competing hardwoods in the southern pine region, but sodium arsenite is too dangerous to both men and animals (including livestock and deer) to be recommended. Ammonium sulfamate is not poisonous to animals and is harmless to handle unless left in contact with the skin for a long time; it is, however, very corrosive to metals. The somewhat higher costs of poisoning competing hardwoods by applying ammonium sulfamate in cups or frills or on notched stumps, or sometimes as a foliage spray, as compared with those for cutting or girdling, appear to be more than balanced by the better results. Ammonium sulfamate has been applied commercially by these methods over many thousands of acres. Latest directions for applying it and other promising hardwood poisons may be obtained from the Southern Forest Experiment Station (20, 112, 148, 187, 459, 548, 565, 566, 567, 571).

PLANTING COSTS, RATES AND RECORDS

Planting Costs

The most comprehensive figures available on the combined costs of preparing sites and transporting and planting southern pine seedlings are those of the U. S. Forest Service for the period 1937-38 through 1941-42. These show planting costs (averaged for groups of ranger districts or of national forests) ranging from \$1.06 to \$11.49 per thousand trees, or 45 to 55 percent of total

seed, nursery, and planting costs (table 6, p. 24). Planting costs per thousand trees for individual Forest Service planting sites, such as might match individual farm or small industrial planting jobs, varied much more widely than these averages for groups of sites. Although the Forest Service planted at 6- by 6-foot spacing (1,210 trees per acre), the presence of some established seedlings and unplanted brush reduced costs per acre almost to those per thousand trees.

Smith published what are believed to be the earliest reasonably complete cost accounts for large-scale commercial planting of southern pine (666). He reported the average cost of planting on 5,200 acres of cutover longleaf pine land in southwestern Louisiana during 1925-26 through 1930-31, mostly with slash and loblolly seedlings, as \$1.60 per acre, or 43 percent of the total for seed, nursery, and planting combined. All planting was by hand, with bars. Most or all of it was at 6- by 8-foot spacing (about 900 trees per acre) in plowed furrows.

Comprehensive data are not yet available for large-scale hand planting at postwar wages, or for machine planting. It seems reasonable to assume, however, that hand planting which cost the U. S. Forest Service an average of \$2.43 to \$4.87 per thousand trees during the CCC program might cost \$5 to \$10 per thousand at postwar wages. Cost figures available on machine planting range from \$2.19 to \$4.08 per thousand trees on old fields and from \$3.87 to \$8.33 per thousand on cutover land, and are reported to be from less than half to about three-quarters of the cost of hand planting on comparable sites (219, 301, 335, 674).

In erosion-control planting and in planting among established pines or hardwoods, higher costs than those quoted for cutover longleaf land can scarcely be avoided.

Prewar ball planting of wildlings with the Council special seedling lifter and transplanter cost \$9 to \$16.57 per thousand trees, depending largely on the distance the seedlings had to be transported and on the skill and experience of the crews (524).

Even when sites, planting methods, spacing, and wages are comparable, costs of planting, like seed costs and nursery costs, vary so much from place to place and from year to year that average costs of past operations can serve as only very general guides in planning new work. Failure to allow for differences in site, methods, spacing, or wages may make planting costs recorded on one job seriously misleading in estimating costs for another.

Rates of Planting

Rates of planting, in terms of trees per man-day or man-hour, are more useful than planting costs in planning new operations or judging efficiency. While rates vary with the training and organiza-

tion of the crew, they are independent of wages paid and (except in extreme cases) of the spacing used, and are related rather directly to the difficulty of planting particular sites and to the methods used. While no comprehensive data on rates are available, the following are among the more reliable examples.

During the 1920's 100 trees per man-hour, exclusive of the time of foremen and tree carriers, was considered the ordinary minimum rate for men working in pairs and planting good stock on open cutover longleaf pine land. The rate was exceeded by the best planters in early commercial planting when soil, weather, and the sizes of seedlings all were favorable, but was not maintained on very wet or heavy soil, in brush, in cold or rainy weather, or with very small seedlings (750). Farm planting was probably slower as a rule, even on favorable sites.

On the national forests during the CCC program, output was considerably improved by having the barman carry and set his own trees, and by rigorously training all planters in correct use of the bar (p. 228). Under normal working conditions rates as low as 100 trees per man-hour were rare on cutover longleaf pine land; rates of 120 to 140 trees per man-hour were common even where some brush and some heavy soil was encountered; a few of the best squads on the easiest sites averaged 270 to 300 trees per man-hour throughout the planting season. These figures are output per man-hour, in terms of averages for all men in the planting squad, including 1 nonplanting leader and 1 or 2 nonplanting tree carriers to each 15 to 17 barmen. The usually high survival of the trees planted by the fastest crews is attributed to the fact that only by nearly perfect planting can planters avoid fatigue and maintain maximum speed.

Coulter reports 500 to 700 nursery seedlings bar-planted per man-day (63 to 88 per man-hour) in farm and commercial planting in Florida (194). These rates probably are conservative for many Florida conditions.

Minckler and Chapman give the following approximate rates (in trees per man-hour) for planting under various conditions in the central, Piedmont, and southern Appalachian regions (513):

Rough, rocky land, mattock-hole planting	38
Smooth land, bar or mattock-slit planting	70
Smooth land, bar or mattock-slit planting in furrows	100

The rates for mattock-hole and mattock-slit planting are slightly below others reported for the Central States (391).

Planting machines, operated by either two or three men including the tractor driver, are variously reported to plant 938 to 1,750 trees per machine hour, with seasonal averages near the lower figure (25, 219, 301, 335, 674).

Seedlings transported from 300 yards (in wheelbarrows) to as much as 1 1/2 to 3 miles (in wagons or trucks) have been lifted and planted with the Council special seedling lifter and transplanter at rates of 184 to 500 trees per man-day (194, 706).

Records

Minimum plantation records should include location, boundaries, area, date of establishment, species, and geographic source of seed. It is also desirable to include the arrangement and spacing of trees the average number planted per acre ; the

class, age, and grade of nursery stock; the exact method of planting used; any insects or diseases carried into the plantation on stock; any dip or spray used at lifting or planting time; and the condition of the site at time of planting, together with any hazard present and control measures used. After establishment, desirable records are locations and dates of pest outbreaks, with mortality percent and nature and effects of control measures; and locations, dates, nature, and results of releases, thinnings, and prunings. Less often needed are records of survival, growth, and yield by periods.

PLANTATION CARE

All southern pine plantations require care from the time the trees are planted until they are cut. They must be protected from a host of enemies—wildfire, sheep and goats, hogs (in the case of longleaf and often of slash), insects, and disease. Heavy mortality the first year or two, as from severe drought, may make replacement planting advisable. Too close spacing or unexpectedly high survival may necessitate precommercial thinning. Commercial thinning is likely to be necessary in any event, and pruning may be wise in some cases.

This section describes plantation injuries and their control, replacement planting, pruning, and first thinnings. Fertilization and cultivation are touched on also, though primarily because of their sometimes harmful effects.

PLANTATION INJURIES AND THEIR CONTROL ⁴²

During the period of adaptation right after planting, and again when the crowns close and leaf surface and the requirements for moisture and nutrients reach a maximum, plantations are likely to suffer worse and more varied injuries than natural stands (94, 108, 302, 616, 623). Because the great majority of southern pine plantations are still very young, the injuries which have attracted most attention to date have been those characteristic of the earlier of these two critical stages. Ills affecting plantations when the crowns close are beginning to appear, however, and may be expected to increase, and some forms of injury may occur at any stage of plantation development.

Indirect control—that is, correct choice of species, seed source, site, planting method, and silvicultural treatment after planting—may minimize injuries by some insects and diseases (94, 108). Often, however, such injuries result because the correct procedures have not been applied, and other injuries occur regardless of such procedures.

⁴²Cooperators in the Bureau of Entomology and Plant Quarantine, the Bureau of Plant Industry, Soils, and Agricultural Engineering, the former Bureau of Biological Survey (now the Fish and Wildlife Service, Department of the Interior), the regional office and national forests of Region 8 of the U. S. Forest Service, the State forest services, the State agricultural experiment stations, and private industry have contributed to this section a mass of invaluable unpublished data, memoranda, letters, and reports far too great to cite or acknowledge in detail. Specialists in the Bureau of Entomology and Plant Quarantine and the Bureau of Plant Industry, Soils, and Agricultural Engineering have reviewed and approved the text in its present form.

In such cases the causes of injury must be controlled directly, if that be possible, and all commercial material salvaged. If the planter fails to act, he risks losing plantations or products that could profitably be saved.

This section gives the available information on the nature and control of injuries of potential as well as of demonstrated importance. It also discusses some trivial injuries, to permit distinguishing them from serious ones on which protection effort should be concentrated. Within each natural group—climate, soil, animals, insects, and diseases—it deals with injuries as nearly as possible in the order of their appearance after planting. Chemicals or poisons suggested as controls are described in detail on pages 202-213.

Fire

Uncontrolled fire is one of the greatest hazards to planted southern pine, even to longleaf the first year after planting and again just after height growth starts. Every precaution should be taken against wildfire, despite the usefulness of prescribed burning to prepare planting sites, control brown spot (p. 162), and reduce accumulated fuel, and despite the fact that occasional plantations have survived uncontrolled fires with little injury.

Climate

Freezing seldom if ever kills southern pines reproduced naturally anywhere in the southern pine region from parents of local geographic race, except while they are in the cotyledon stage (169, 601). In several instances, however, freezing either of the roots of 1-0 seedlings during lifting or planting, or of the soil around the roots within 1 to 2 weeks after planting, has been the apparent cause of serious mortality, particularly of slash pine.

When the roots freeze during lifting or planting, death seems to result from direct injury to the root tissues. When the soil freezes after planting, death seems attributable to excess of water loss over intake, particularly since mortality has been heaviest on bare or nearly bare sites and comparable seedlings frozen in the heel-in nearby have escaped injury. With both types, the symptoms have been the same: a yellowish or grayish bleaching of the foliage, accompanied by drooping and followed by browning and death of the seedlings, all within a very few weeks or even days after the freeze.

Control consists of not lifting and planting during freezing weather, and of stopping planting on advance notice of hard freezes; less directly, of avoiding exposure of planting sites by furrowing, scalping, or burning.

Frost heaving is the lifting up and exposure of part or all of the seedling root system by soil movement accompanying repeated freezing and thawing. It sometimes kills moderate to large percentages of newly planted seedlings and occasionally affects seedlings after 1 year's growth in plantation. It is intensified by bare, heavy, or poorly drained soil, and by the use of small seedlings (162, 286, 361, 471, 513, 798). It can be avoided or controlled by maintaining vegetative cover (as by not burning sites before planting), planting in the spring after the worst frosts are over, using large stock, and mulching the trees on bare planting sites with pine needles, grass, or straw.

Heat, although popularly assumed to be a serious hazard to newly planted southern pines, seems to have caused no such damage in the South as it has in the West and North, and particularly in the Lake States (616, 641). Definite evidence of heat killing of southern pines, even in the first year, and specific symptoms of their injury by heat, have not been reported.

Drought, not only from lack of rain but also from other circumstances which increase water out-go over water-intake, is one of the most widespread and serious hazards to young southern pine plantations (194, 666).

Obviously, many of the circumstances which result in drought-killing (p. 123) are most likely to affect the seedlings during the first growing season after planting (fig. 8, p. 20). Several of them, like root injury, frozen ground, and soil excessively dry at planting time, have caused visible injury within the first few days after planting and serious mortality within 1 to 2 months.

The symptoms of mild but long-continued or chronic drought are abnormally slow growth, accompanied in the more severe cases by yellowing or fading of the foliage, and the browning and death of some needles. The oldest needles and those only partly developed may show the effects of drought more than those which have recently reached full development. Reduction of vigor by drought intensifies attack by some insects and diseases; severe tip-moth attack on loblolly pine on badly eroded sites, and heavy brown-spot infection of slash pine planted in the hard subsoil of old borrow pits, are characteristic examples. In the most severe or protracted droughts all the foregoing symptoms are intensified and part or all of the seedlings die.

In young seedlings not yet well enough established to resist, the characteristic symptoms of severe but not necessarily prolonged drought are drooping of the foliage (sometimes accompanied by bleaching to yellowish or grayish tint); wilting or shriveling of newly formed immature

needles; failure of buds to open or to continue elongation; browning of all the foliage and death.

Some of these symptoms are hard to tell from those of other injuries. Occurrence in connection with shortage of rain or soil moisture, or in the presence of nonaffected deep-rooted competing plants (lespedeza, for example) often confirms them, however. Such supplementary evidence should be considered when drought injury is suspected.

Defense against drought consists of any and all nursery and planting practices which will enable the seedlings to take in more water through their roots than they lose through their tops. These have been discussed in the sections on planting.

Wind damage, as distinct from glaze (ice) and snow damage, has not been reported as particularly serious in southern pine plantations. Trees less than 5 feet high usually escape. Taller trees suffer variously from branch breakage, trunk bending, trunk breakage, and windthrow follow-in°. failure of the roots to hold. Slash pine seems to be the worst sufferer (177), apparently because of its shallow root habit, heavy crown, and perhaps (378) because of low strength as a result of very rapid growth. Slash pines with trunk cankers of southern fusiform rust seem much more likely to break off at the canker under the impact of strong wind than under the weight of ice or snow. Slash pines planted with U-roots sometimes develop globes of root just under the soil surface, which form "ball and socket joints" when the soil is wet, and let the trees go over in high wind. Experimental evidence and wide observation both show, however, that the danger of windthrow from planting U-roots has been exaggerated.

Young southern pines of all species, but perhaps especially slash pine, straighten up again remarkably even though their trunks have been bent within a few feet of the ground by wind, ice, or snow. They do it, however, by forming compression wood on the under side of the bend, to the detriment of practically all products, even pulpwood (379). Such bent and recovered trees, generally recognizable by a slight curvature near the base, should be among the earliest removed in thinnings.

Glaze (ice) and snow injure or kill planted southern pines by breaking branches, bending or breaking the trunks (fig. 44), or partly or completely overthrowing the trees.

Slash pine is most susceptible to glaze injury, and shortleaf least. Smaller trees, including some less than 5 feet high, are especially likely to bend or lean, and trees more than 15 feet high to suffer branch and trunk breakage. Glaze and snow, unlike wind, apparently have little tendency to break rust-infected trees at the canker.

The extent and seriousness of damage vary enormously from locality to locality, year to year, and plantation to plantation (34, 322, 378, 379, 458, 512, 534, 538). Damage is more frequent



FIGURE 44.—Ice damage to planted slash pine near Alexandria, La. A and B, Bending and partial recovery of young trees immediately after and 8 months after storm, respectively. C, Top breakage of older tree in storm 3 years before picture was taken. D, Permanent deformity resulting from bending of older tree.

toward the north, but sometimes occurs on the gulf coast. Glaze seems much more injurious than snow, presumably because accompanying wind intensifies glaze damage while it may shake snow off the crowns. The worst and most frequent damage has been reported from the central and northern parts of Georgia, Alabama, Mississippi, Louisiana, and eastern Texas, where ice storms are common, rather than from more northerly locations where snow is commoner than glaze. In single storms of large extent, damage may be much more severe toward the northern edge of the storm area. Even in severe storms, damage is generally spotty.

Branch breakage, unless extreme, is seldom fatal. Trunk breakage below the living crown is fatal; trunk breakage low down in the live crown, usually so. Breakage high in the crown may leave the tree alive and growing, but fit for short-length, low-grade products only (fig. 44, C). Trees less than 15 feet high, especially if leaning only moderately, often recover remarkably (fig. 44, A and B), but at the cost of forming compression wood. The larger the trees the more likely they are to be permanently deformed. Glaze or snow damage

sometimes results in mortality from attacks of *Ips* beetles (p. 156) the following summer.

In localities of high hazard, all reasonable precautions should be taken to minimize possible damage. These include (a) substituting other species for slash pine to the fullest extent feasible, and (b) maintaining full stands of stout-stemmed, long-crowned trees by planting at relatively wide spacing (6 by 7 to 8 by 8 are suggested), removing the shorter-crowned, more slender trees in thinning, and perhaps pruning no trees artificially (371, 528, 534, 627). Excessively wide spacing should be avoided, however, lest glaze damage leave too few well-formed trees for profitable management (534). Mixing other species with slash as insurance against glaze damage is questionable; in at least one loblolly-slash mixture the bending of slash by glaze increased the injury to the intermingled loblolly (34).

Merchantable trees that are severely injured should be salvaged before warm weather, or at least within the first growing season after injury, but moderately injured trees may often advantageously be left at least until the next scheduled thinning.

Hail storms are relatively infrequent and usually limited in extent. The lighter ones affect planted pines very little, but an occasional heavy fall of large hail stones may severely damage the particular part of a plantation it hits—killing some trees by defoliation followed by *Ips* beetle (p. 156) attack, slowing down growth of the survivors, and causing bark scars that take years to heal (703).

Soil

Excessive soil moisture tends to reduce the rate of growth of planted southern pines, especially loblolly (583), from the first year onward. Occasionally it causes severe mortality, either directly or through the formation of a very shallow root system which fails to supply the tree when protracted dry weather greatly lowers the water table. The injuries are limited to flat sites, visibly wet during most planting seasons, and further distinguished by pitcher plants, sedge, sometimes sphagnum moss, and usually by crawfish burrows. Yellowing of the needles is a common symptom of injury; on trees one to about three years in plantation, hypertrophied lenticels frequently develop just above and just below ground. Injury may be avoided or reduced by substituting slash pine for loblolly or longleaf, by plowing furrows and planting on the furrow slice, or, where economically feasible, by draining the site.

Soil erosion reduces the growth of planted pines, deforms them, or kills them outright. Injury may begin with the first hard rain after planting. It continues in varying degree till erosion has been arrested. It is most likely to occur where erosion-control planting is undertaken. In one case, loblolly plantations on severely eroded soil survived only half as well and produced only one-fifth to one-quarter as much volume in 16 years as others where erosion was slight (102).

Injury can be reduced to some extent by preserving existing vegetative cover ; by not furrowing the planting site or by furrowing on contours only ; by using fairly large stock of high physiological quality, and, frequently, by mulching (p. 125). Wherever southern pines planted on eroding sites have managed to live and make a little growth each year for 2 to 4 years, they have exhibited a remarkable ability to mulch themselves with their own needle fall, to the great improvement of the site and of their own growth rate thereafter (282, 321).

Silting consists of the washing of soil against the stem, foliage, or buds of planted seedlings. The presence of water-deposited soil above the seedling root collar is clear evidence that silting has taken place. It may affect planted longleaf pine any time before active height growth begins, but is likely to affect other species mostly during the first year after planting, and then only if the seedlings are unusually small or soil wash is extreme.

Setting seedlings one-half inch higher than they grew in the nursery is no longer recommended as a control measure. On land not actively eroding, silting can be minimized by contour furrows, substituting scalped spots for furrows, or planting in unburned or 1-year-old rough.

Low soil fertility appears to be one of the commonest causes of poor growth of planted pines, especially on very sandy soils and on subsoil exposed by erosion, and possibly (780) on very acid soils. Indirectly it may cause mortality, as by delaying the height growth of longleaf seedlings until brown spot kills them. No practical control is known. For reasons stated elsewhere (p. 168), artificial fertilization is not recommended.

Animals

Hogs, especially those with some razorback ancestry, eat the starchy bark of southern pine seedlings. They prefer longleaf, and, over the southern pine region as a whole, range hogs probably have ruined more longleaf plantations than drought, pocket gophers, leaf-cutting ants, and brown spot combined. To this species hogs are infinitely more destructive than fire. They root out small seedlings entire (fig. 45, A), sometimes at rates of 6 per hog per minute and of 200 to as many as 1,000 per hog per day. They seem to prefer machine-planted to bar-planted seedlings, presumably because they are easier to find and to uproot. They girdle the roots of larger seedlings, and strip the surface lateral roots of larger seedlings and saplings for distances of many feet (fig. 45, B). Although hogs damage slash pine less extensively than longleaf, complete destruction of 900 acres of slash pine within 1 year after planting has been reported. They occasionally injure loblolly pine. (333, 334, 746, 750.)

Although it does not completely solve the hog problem, fencing plantations, maintaining the fence carefully, and expelling hogs repeatedly until the trees approach pulpwood size will greatly reduce the damage (794). Where there are many hogs it is foolhardy to plant longleaf pine without fencing, though mixing another species with longleaf helps somewhat (pp. 12-14).

Sheep and goats sometimes kill loblolly, slash, and shortleaf pine seedlings during the first year after planting, by browsing on them. They may deform a good many and kill a few for a few years thereafter. Sheep retard the height growth of longleaf seedlings, often 25 percent or more, from the time height growth starts until the seedlings are 40 to 48 inches high, by biting off terminal buds, particularly in the winter and spring. Repeated biting also results in much forking of leaders, and eventually kills some trees. Sheep at the rate of even 1 per 47 acres have seriously damaged young longleaf stands by biting the buds ; sheep at the rate of 1 every 13 acres, in well-stocked stands of longleaf up to 4 feet high, have injured 86 per-

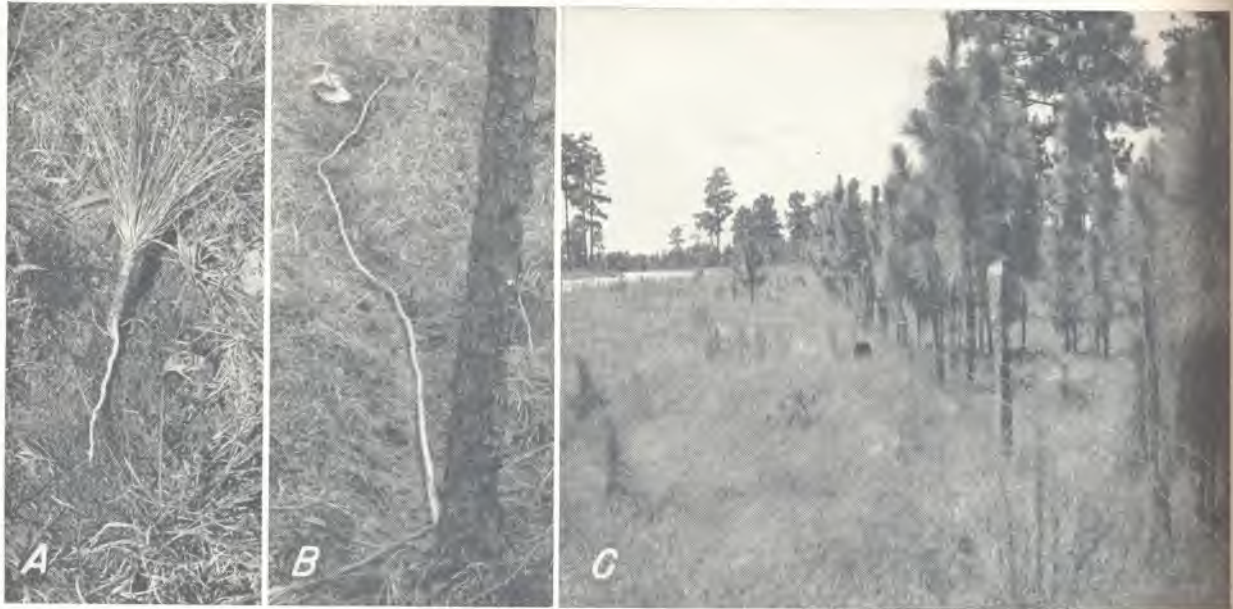

FIGURE 45.—Hog damage to southern pines. *A*, Small longleaf killed by uprooting and stripping of root bark. *B*, 14-foot slash pine with 16 feet of one lateral root uncovered and stripped of bark. *C*, Site to left of woven wire fence, with same soil, seed source, and fire history as that to right, practically cleared of longleaf seedlings by hogs.

cent of all seedlings. Goats bite out longleaf buds in much the same manner as sheep. (23, 476, 666, 746, 750.)

Both sheep and goats should be excluded from southern pine plantations until the buds and most of the foliage are out of their reach.

Cattle may kill newly planted southern pine seedlings by browsing or trampling them or accidentally pulling them up, kill or deform slightly older ones by browsing, and deform saplings up to 10 feet high by "riding them down" to rub insects off themselves.

Damage may be serious on limited areas of overstocked range, especially where cattle gather near gates, water, feed troughs, or salt, where newly planted pines are the only green food in sight, or where feeding of concentrates has made the animals hungry for roughage (1, 80, 194, 282, 283, 513, 750). Damage is particularly likely in small plantations on farms. Ordinarily, however, unless their presence leads to uncontrolled burning of the range, cattle do negligible damage to planted southern pines (081, 282, 283, 513, 666, 745, 750). Furthermore, even light grazing may appreciably reduce fire hazard by reducing the fuel, and may also, especially in the longleaf pine type, offer an attractive source of income from plantations until crown closure greatly reduces the forage (111, 145).

Cottontail rabbits (*Sylvilagus floridanus* alacer Bangs in the lower South; presumably *S. floridanus mallurus* Thomas in the Atlantic Coast States) and possibly also swamp rabbits (*S. aquaticus aquaticus* Bachman) cause frequent light and occasional severe injury to loblolly,

slash, and shortleaf pine seedlings. They bite off the side branches, buds, upper tops, or entire seedlings, usually the winter they are planted, sometimes the winter following. They bite them off cleanly, usually at an angle of about 45 degrees, in contrast to the irregular cut or break made by cattle, sheep, or goats. They seldom injure the needles, and, unlike hogs, rats, and some insects, do not strip or chafe the bark. Often, though not always, they leave the side branch or top uneaten beside the cut stub. They are much more likely to injure small seedlings than large ones. Damage may not start until cold weather in middle or late December has killed most late-season green vegetation, and often decreases abruptly during late January or early February. It is most likely to be extensive where rabbits are abundant and have good cover, such as heavy broomsedge (*Andropogon*) rough or heavy scrub oak or other brush. (6, 53, 402, 449, 509, 668, 776, 800.)

The seriousness of rabbit damage depends more on the mortality percent of the injured trees than on the percentages bitten. Recovery from injury during the second winter usually is good. Where the rabbits bite off the tops 1 to 4 inches above the ground during the first winter, or bite only buds or side branches, recovery frequently is good. If the seedling are large and of high quality, the site is moist, and the weather after planting is favorable, survival may be good even when seedling are bitten off within one-fourth inch of the ground, but there may be 10 to 30 percent loss of 1 height growth during the next 5 years, and some forking of main stems at the ground. On dry sites and in dry years, or with small planting

stock, biting off of 60 to 100 percent of the seedlings during the first winter has caused enough mortality to ruin plantations. (750, 776.)

Rabbit damage may be reduced by : (a) Substituting longleaf pine, which rabbits seldom if ever injure, for more susceptible species; (b) planting susceptible species after January 15 to February 15; (c) planting only large seedlings of these species ; and, in some instances, (d) burning over the site before planting. The U. S. Forest Service, in cooperation with the old Bureau of Biological Survey, found a copper carbonate-asphalt emulsion mixture (p. 213) effective in repelling rabbits, and applied it, just before lifting, to seedlings to be planted on sites where rabbit damage seemed likely to be severe.

Eastern pocket gophers (*Geomys* spp., locally known as "salamanders") apparently vary in importance as plantation pests. In the west Louisiana-east Texas part of their range (fig. 4, p. 8) , where *Geomys breviceps breviceps* Baird is the common variety, they have frequently killed most or all trees on areas of half an acre to several acres, and have caused average mortalities of 3 to 20 percent throughout thousands of acres. Damage by other varieties further east has not been recorded in detail, and may be less. Gophers eat the roots of pines they encounter in tunneling, consuming part or all of those of trees 5 feet or more in height, and often pulling smaller pines bodily into their tunnels and consuming them entirely. They often start killing trees within a few days or hours after planting. Often they kill too few trees, at first, to seem important, but increase in number and extend their depredations inconspicuously for several years until they have reduced the planted stand below the acceptable level. (53, 150, 201, 466, 666.)

Though seldom seen because they live and feed underground, pocket gophers, when found, are readily distinguished from other injurious rodents. They are stoutly built, with bodies about 7 inches and tails about 3 1/2 inches long. Their ears and eyes are small ; their front feet are strong, with long, stout claws well developed for digging; and they have fur-lined pouches opening in the sides of their faces, in which they carry food. The usual signs of their presence are mounds of earth, each a foot or more across, at intervals of a few feet along their irregular burrows; and pale or reddish brown dying or dead trees, often leaning, which are easily pulled up and which reveal only a blunt wooden point where the roots used to be. The burrow system is elaborate, with main and secondary tunnels, and separate storage and sleeping chambers. Most tunnels and chambers are only a few inches below the soil surface. In the southern pine types at least, pocket gophers prefer well-drained soil, coarse sandy soil, or soil with deep rather than shallow sandy surface soil layers above stiffer subsoil. They burrow most actively, and are most easily discovered and controlled, from November until May. (53, 201, 4E6.)

Planting the Southern Pines

Control is by strychnine baits, or trapping (p. 232). In Louisiana and Texas, at least, it should be applied wherever abundant fresh mounds are found on planting sites, without waiting to find evidence of injured trees. Preferably control should be started a year before planting, and in no case later than the first winter after damage appears. Until the trees are about 8 feet high, annual reinspection, with retreatment wherever gophers have remained active, is essential.

The *cotton rat* (*Sigmodon hispidus hispidus* Say and Ord) is the suspected cause of a partial or complete girdling, at or just under the ground line, which weakens or kills planted southern pines up to 2 feet high. The injury, which has been found from Georgia to central Louisiana, is invariably associated with old, heavy rough, known to be favorable to cotton rats (402). The damage is generally unimportant, but is sometimes severe in small areas. It has been noted most frequently on planted and natural longleaf seedlings still in the grass stage. It is easily distinguished from hog damage because the girdles are too narrow to be made by hogs and sometimes show clearly the marks of small rodent teeth ; also there is no rooting of the soil, but at most a shallow digging, as by small animals. Burning off the site in advance of planting is suggested as a safeguard where cotton rats are known to be abundant; longleaf plantations in which the injury occurs may be prescribe-burned.

Mice, although an obstacle in the nursery (p. 85) and to direct seeding, appear to be a negligible hazard to planted southern pines (506).

Insects

Early discovery and prompt action greatly facilitate control of any forest insect. These require frequent, observant travel through the plantations and, usually, advance provision of the equipment and supplies most likely to be needed. For an organization with a planting program of several thousand acres, hand sprayers or highly mobile truck-mounted sprayers sufficient to cover 100 to 200 acres of young plantation in 2 or 3 days would seem a minimum safeguard.

Correct diagnosis may be fully as important as prompt discovery of the trouble. Often the planter can identify insects closely enough to choose the type of insecticide to apply, but can follow up the first treatment more effectively if he learns the exact identity of the pest, together with details of its life history. This may require bottling, in ordinary rubbing alcohol, several specimens of the insects and typical examples of their work and mailing them to the Bureau of Entomology and Plant Quarantine, U. S. Department of Agriculture, Washington 25, D. C., or to the State experiment station. The specimens should be labeled with date and place of collection, and accompanied by the fullest possible description of the outbreak.

Insecticides suggested here are described on pages 202-208). Many are extremely poisonous to humans, and their use involves perhaps the greatest single hazard to workmen in the whole process of pine planting. The possible importance of spreaders and stickers (p. 211) should not be overlooked. A suitable soap spreader, for example, may double the effectiveness of nicotine (294). Although low costs per acre or per tree treated may justify control by airplane dusting or spraying on large planting operations, the total costs will be large. The investment may be wasted through errors in formulating or dispersing spray or in choosing the exact time of application. The planter should therefore consult specialists before undertaking such large-scale control.

Texas leaf-cutting ants (*Atta texana* Buckley, known locally as "town ants") defoliate planted longleaf seedlings, and remove the needles and buds and often the bark of planted slash and possibly of other pines, particularly during the winter months. Within their restricted range (fig. 4), these ants are a serious plantation hazard. Their depredations have necessitated the treatment of thousands of acres of national-forest planting sites in Louisiana and Texas. Failure to treat before or at the start of planting has resulted in injury of more than 50 percent of slash pine seedlings in some plantations, and sometimes in defoliation of all longleaf seedlings on a hundred or more acres within 24 hours after planting. Among longleaf seedlings defoliated by ants, mortality of 70 percent or more is common, and slash seedlings injured by them almost invariably die. (149, 198, 335, 549, 666, 677, 678, 776.)

The tiny mandibles of the ants leave the injured tissues of the seedlings more minutely irregular and frayed than do the teeth of any animals, and do not score, cut, or splinter the wood. The ants do not leave the central portions of the needles as do *Colaspis* beetles, or conspicuous excreta as do sawfly or *Tetralopha* larvae. They do not eat the needles, but carry them to underground chambers and grow fungi on them for food. They often leave 1/2- to 1-inch lengths of needles near the seedlings, and the ants themselves may be found actually defoliating the seedlings. They are more distinctly red than the common mound-building harvester ants, and of several different sizes (castes), the largest with enormous heads and jaws.

The injured seedlings usually are within easy sight of a colony or "town." The colony consists of groups of mounds. Each mound is 8 to 24 inches or more in diameter, craterlike till washed down by rain, colored (frequently red) by subsoil, and containing one or more burrows about half an inch in diameter. The closely spaced mounds of one colony may cover from a hundred square feet to 3 acres of ground. Lateral burrows and, beyond them, 1-inch-wide cleared trails leading through the grass, often extend a total of 800 feet or more beyond the outermost mound of the col-

ony. Colonies occur at the rate of 1 per square mile to 1 every 15 or 20 acres, usually on ridges or well-drained slopes (especially south or west slopes) with deep, sandy surface soil. In addition to the conspicuously darker subsoil in the mounds, abnormally thin grass among the mounds and often a dense, rank growth of dog-fennel (*Eupatorium caillifolium* Small) make all but the newest colonies conspicuous, especially in winter. (675, 761.)

Control is by fumigating the burrows with methyl bromide or carbon disulfide applied in winter (p. 223). Frequent scouting for colonies is necessary, as winged queens can start new ones by flying considerable distances after mating. Treatment must be thorough and checked later, as queens may escape fumigation and rebuild the population before newly planted trees, especially longleaf, are large enough to escape serious injury.

Adult weevils (*Hylobius pales* Hbst. and *Pachylobius picivorus* Germ.) attack planted loblolly and slash pine seedlings in the spring. They start with the tender bark near the buds and work downward to strip the bark from the stems and even from the roots to depths of 1 to 5 inches. In north central Louisiana they have caused up to 90 percent mortality in several extensive plantations established after clear cutting the previous fall to salvage fire-killed pine stands. From this and the known habits of *H. pales*, it is thought that the stumps and tops left after logging lead to concentrations of the weevils such as may prevent successful planting within 2 or 3 years after clear cutting. *H. pales* has also been found killing small natural longleaf seedlings in Florida. (198, 637.)

The larvae of the *Nantucket tip moth* (*Rhyacionia frustrana* Comstock) kill back the tips of planted and natural loblolly and shortleaf pines practically throughout the southern pine region by making longitudinal burrows in the terminal shoots and the ends of the main side branches. Slash pine is attacked nearly as often as loblolly and shortleaf, but (presumably because of its freer pitch flow) is killed back much less severely, and recovers much better. The Nantucket tip moth almost never attacks longleaf pine. (36, 93, 121, 228, 282, 283, 296, 521, 577, 750, 751, 800.)

Nantucket tip moth clearly is no problem in slash and longleaf pine plantations, but opinions differ widely concerning its seriousness on planted loblolly and shortleaf pines. Injury to young loblolly and shortleaf is conspicuous. It undeniably reduces height growth appreciably through the fifth and sometimes through the tenth year after planting, and causes some trees to crook or fork. Both deformation and loss of growth seem worst on the poorest sites and near or beyond the borders of the southern pine types. The insects seldom kill a tree, and, in general, visible evidence of injury practically disappears before the trees reach minimum pulpwood size. The tip moth

therefore seems to be a minor handicap rather than a major obstacle to planting.

The commonest evidence of tip moth injury is the dying or dead twig tips, visible in some stage practically throughout the year. The larval burrows are visible when the twigs are broken open; exit holes in or near the dead buds, often surrounded by pitch, are characteristic. Still living or recently dead twigs usually contain one or several small, light-colored maggotlike larvae apiece, or small, light brown pupae; the pupae wiggle at intervals when breathed on or held in the hand. During the flights of adult moths, empty pupa cases that are split open at the head end can be found in the emergence holes in or near the buds.

The adults are weakly flying moths about one-eighth of an inch long. Their wings, steeply sloping when at rest, are fringed at the end, and are silvery in color, irregularly crossbarred with brown, matching almost perfectly the sheaths around the bases of loblolly pine needles.

Eggs are laid on needles, buds, and the tender bark of new shoots, and the earliest sign of larval activity is a minute chafing or channeling of needles near the sheath, and of tender bark, as the larvae feed and begin to burrow. A little later, elongating shoots curve, develop pitch blisters where the larvae have entered, and give evidence of dying, and small larvae can be found in short burrows inside.

In the Gulf Coast and adjacent States the moths produce four generations a year, generally at about the time the pines are making new spurts of growth. One generation overwinters as pupae in the twigs; each of the other three completes its life cycle in not more than 8 to 10 weeks. In southeastern Louisiana peak flights usually occur in March, May, July, and September, with pupation following, respectively, in April and May, June, August, and over winter (751). At Stillwater, Okla., in 1946, peak flights occurred March 22, June 1' to 10, July 10 to 24, and September 5 (36). First flights in Tennessee, Kentucky, and southern Illinois begin about the end of February and in southern Ohio about the end of March; in Ohio there are apparently only two generations a year (296).

Control of Nantucket tip moth otherwise than by careful choice of species or species mixture, or by close spacing to improve the form of injured trees, seems generally unnecessary. In exceptional cases it may pay to spray large loblolly or shortleaf plantations on poor sites with DDT, provided care is used to catch the insects during oviposition and egg hatching. Infested stock intended for isolated and uninfected sites, particularly beyond the borders of the southern pine types, should be dipped in a miscible oil emulsion, alone or with nicotine, or sprayed with DDT at the nursery, but this precaution is useless in planting on sites on which the tip moth is already present.

Rhyacionia rigidana Fernald, a shoot moth somewhat larger than the Nantucket tip moth and

capable of killing back slash pine conspicuously, was identified on slash pine in Lanier County, Ga., in June and again in September 1929. Craighead and also Doane and coauthors mention it as attacking loblolly and Virginia scrub pine in the Atlantic States, and Craighead says it has either 1 or 2 generations a year (198, 232). The apparent lack of any later reports indicates that it is an unimportant pest in southern pine plantations.

Sawfly larvae partly or completely defoliate southern pines, planted or natural, from the age of 1 year onward. Potentially at least, sawflies are a considerable hazard to southern pine plantations because of their demonstrated ability to kill some trees and to reduce appreciably the growth of entire stands over large acreages (96, 246, 383, 626). The commonest species seems to be the red-headed pine (Leconte's) sawfly (*N eodiprion lecontei* Fitch), which attacks all the principal southern pines, but at least two other species attack loblolly, and at least three others attack shortleaf (198, 383, 417, 577, 626, 750).

Sawfly larvae eat needles down from the tip instead of cutting them off at the base as do leaf-cutting ants. Whereas ants confine their attacks to small seedlings and to the winter months, sawfly larvae feed on pines of all sizes, and usually in the warmer months, and in many localities beyond the range of the ants. Sawfly larvae frequently leave the needles only partly consumed, but, except when the larvae are very young, leave the basal portion, not a central core as *C olaspis* beetles do. The ground under sawfly-injured trees usually is liberally sprinkled with excreta, but, in contrast with *T etralopha*, the larvae leave no webs full of excreta on the trees.

Sawfly larvae look like the caterpillars of moths or butterflies, but have only 8 (occasionally only 6) pairs of fleshy jointless prolegs under the rear three-fourths of their bodies, whereas most moth or butterfly caterpillars have 10 pairs. Depending on their age and species, sawfly larvae vary from one-eighth inch to nearly 1 inch long. They are hairless, and usually striped or spotted; the larvae of the red-headed pine sawfly are variously spotted, and have orange, mahogany-red, dark brown, or nearly black heads (fig. 25, D, p. 86). They feed in groups; often two or three larvae work opposite each other on different sides of a needle, eating it off completely as they back downward from the tip. When jarred or startled, they rear back suddenly and remain motionless for a moment.

Sawfly larvae are easily controlled by spraying with DDT or arsenate of lead, but attempts to kill all sawfly larvae appearing in plantations are not recommended. Concentrations on single or scattered trees, or light outbreaks covering a fraction of an acre or even several acres, can do little harm in themselves. Close watch should be kept for large outbreaks, however, and places known to have been infested once should be watched for larger and heavier reinfestations. Any outbreak

large and heavy enough to cause economically serious losses, or threatening to progress to dangerous size, should be controlled promptly by spraying. If the sawfly population is indeed building up, each successive brood will cover more area, and be harder to control. If the current brood is discovered just as it is about to stop feeding and begin to pupate, one or two days delay may make spraying useless.

Pine webworms are the larvae of a stout, soft-bodied moth *Tetralopha robustella* Zeller. The ¾-inch long, brown-striped caterpillars often feed singly or in small numbers on the needles of southern pines, especially within the first 2 years after planting. The caterpillars have been reported in early summer, but more often in the late summer, fall, and midwinter, usually on the most recent foliage (that nearest the terminal bud) of slash and longleaf pine. Each caterpillar lives in a mass (sometimes a distinct tube) of excreta and webbing. These tubes are conspicuous, and make the injury look worse than it really is. The larvae are not heavy feeders, and rarely do much harm unless they are unusually abundant or the seedlings are very small and weak when attacked. They can be controlled with DDT or arsenate of lead.

The adults of *Colas pis pini* Barber, brownish beetles about three-sixteenths inch long, have attacked young planted pines of the four principal species at intervals since 1924, and also young and mature natural stands, at widely separated points from South Carolina and Florida to southeastern Louisiana. The largest and most frequent outbreaks—10 to 600 acres—have been reported from southeastern Louisiana and the adjacent portion of Mississippi. The adults emerge in June, and feed for considerable periods, usually on the outer ends of the current year's needles. First the outermost and then the remaining portions of the injured needles turn reddish brown. From a little distance an infested plantation looks as though a fire had run through it. Close examination shows that the beetles have eaten the edges of the needles but left the central portions; sawflies, by contrast, usually eat the entire needle as they go. Damage sometimes is mainly to the upper part of the crown. The visible external traces often disappear within a few months. Some decrease in growth has been suspected, but little or no mortality has followed attacks. The beetles are easily controlled with lead arsenate and presumably with DDT, but spraying hardly seems justified unless the outbreaks recur or increase the second year. (198, 679, 750.)

White-fringed beetles, whose economic importance necessitates rigorous inspections and quarantines affecting nursery stock (p. 87), appear to feed little, if any, upon pines. DDT has been found extremely effective against this insect, and, should attacks on pines develop, the latest specifications for control should be requested from the

U.S. Bureau of Entomology and Plant: Quarantine, Washington 25, D. C., or its local offices.

Bark beetles, especially the *southern pine beetle* (*Dendroctonus frontalis* Zimm.) and various species of *Ips*, become an increasing threat as planted southern pines approach maturity. Adults and larvae of these beetles cut egg chambers and galleries, respectively, through the cambium layer, removing part of the outermost wood and the inner bark. The beetles are most active in warm weather, and in fire-weakened drought-weakened, and otherwise injured trees. They seem more of a hazard in the Piedmont and in the 'Appalachian foothills than in the Coastal Plain. *Dendroctonus* occurs in serious epidemics at considerable intervals, disappearing almost completely between times; during epidemics it kills vigorous nature trees. It can be controlled by utilizing the trees and burning the infested bark of brood trees. Recent investigations have shown that broods in trees can be controlled by spraying the trunks with an oil solution of benzene hexachloride. *Ips* is a moderate hazard every year, and sometimes becomes seriously epidemic in drought years. It attacks mostly weakened or injured individual trees or groups, but sometimes kills vigorous young saplings. (198, 199, 232, 289, 703.)

Plantations damaged by fire, ice, hail, or lightning should be watched closely for *Ips*, especially from about March onward until cold weather the following winter. Signs of *Ips* are fading and browning of the tops, small pitch tubes on the trunks, and characteristic galleries under the bark, and, ultimately, small emergence holes through the outer bark. (*Ips* larvae are small, not to be mistaken for the larger "sawyers" or flat-headed borers that infest dead trees.) *Ips*-infested trees of merchantable size should be cut and salvaged; if they are cut and utilized while the larvae are still in them (that is, before emergence holes appear), enough of the insects may be killed to stop their spread. There seems little use in cutting infested trees below merchantable size.

From March till late fall, and occasionally over a mild winter in the lower South, tremendous populations of *Ips* build up in fresh tops and other residue of logging, including thinning for pulpwood. The beetles may then attack weakened standing trees nearby, and even thrifty trees of small size. Since commercial logging and thinning cannot be confined to cold weather, the beetles are an ever-present threat to the stands left. The threat, however, is usually negligible so long as the operation is continuous over considerable areas and fresh supplies of tops become available week by week during warm weather. A small, isolated cutting in warm weather often leads to *Ips* attack on living trees in and around the cutting. For this reason, isolated thinnings on experimental plots or in small farm plantings should be made in midwinter.

Insects of apparently minor importance. Several insects of minor importance have been reported in southern pine plantations or in young natural stands under conditions resembling those in plantations. Artificial control is not recommended unless local evidence shows appreciable injury and aggressive spread. They include :

Grasshoppers, which have been observed partly defoliating pine seedlings the first year after planting.

Scale insects, especially *Toumeyella parvicorne* Ckll. on young leaders, twigs, and needles, and *Chionaspis (Phenacaspis) pinifoliae* Fitch on the needles, reported in each of several Southern States. (Although these seem to do little harm when infestation occurs after planting, active

Toumeyella infestation on nursery stock late in the nursery growing season usually results in heavy mortality after planting.)

Aphids, on planted slash and loblolly pines up to 5 years old.

Larvae of the moth *Dioryctria amatella* Hulst. (primarily a cone borer), which have been found burrowing in the elongating leaders of the longleaf pine in Louisiana and Mississippi in the spring and in the late summer (198).

A *needle miner* of the genus *Recurvaria*, which has occasionally attacked young longleaf pine in Louisiana and Texas in April, August, and November.

The Zimmerman pine moth, *Dioryctria (Pinipestis) Zimmermani* Grote, a bark borer the larvae of which have attacked the trunks of planted shortleaf and other pines in Ohio and elsewhere (198, 577).

When the seriousness of insect attack on a plantation is in doubt, identification of one of these minor insects as the cause of injury may save unnecessary expenditures for control.

Diseases

Southern fusiform rust is the most serious disease so far encountered in the southern pine planting program. It is caused by *Cronartium fusiforme* Hedgcock and Hunt. This fungus infects slash and loblolly pines in the nursery and from the first spring after planting until they are at least 50 to 60 feet high, forming cankers on the branches and trunks. It also infects longleaf in the nursery and doubtless infects some planted longleaf before it starts height growth. Infection continues until after longleaf reaches merchantable size, though seldom as extensively as on slash and loblolly. Fusiform rust is rare on shortleaf pine (footnote 35, p. 92). (315, 654, 658.)

Seedlings infected in the nursery seldom survive planting (p. 91 and fig. 27). Infection incurred after planting kills many trees (fig. 46, C) and reduces the value of products from the survivors (fig. 46, F, G, and H). The rate of infection is high within most of a wide territory (fig. 4)

and in many restricted localities outside it, and has shown an alarming tendency to increase (fig. 46, A and C) in places where the hazard originally seemed slight.

The South's two favorite planting species, slash and loblolly pine, suffer most from the rust, and mortality is particularly heavy in slash. Thirty percent mortality, with 60 to 80 percent trunk infection among the surviving trees, is not rare in slash pine plantations still below minimum pulpwood size (fig. 46, B and C). Infection of both branches and trunks (fig. 46, D) continues as the trees grow. Infection is progressive; branch cankers, relatively harmless in themselves (fig. 46, E), grow into and dangerously involve the trunk (fig. 46, F), and trunk cankers may increase enormously in size (fig. 46, A, F, and G). In contrast to brown-spot and other needle infections, which are shed or burned with the needles, rust infections in the main stems can be eradicated only by cutting the trees. Except in the nursery, the rust is almost wholly unpreventable and uncontrollable by direct means. (282, 283, 303, 654, 658.)⁴³

*Cronartium fusiforme*⁴⁴ requires two different hosts, pine and oak, to complete its life cycle. Within a single growing season, infection passes from pine to oak, from oak to oak, and from oak back to pine again. On the individual pine, infection frequently extends downward along the branch into the trunk, but it cannot spread from one pine tree to another (315, 654, 655, 658).

The round of infection from pine to oak to pine occurs only in the spring—in the Gulf States, usually from about mid-March to mid-June. It begins with a tremendous production of orange *aeciospores* on branch and stem cankers on the pines, in March and April, rarely in late February. These infect the new foliage on various oaks. Oaks differ greatly in susceptibility. The red or black oaks, including southern red oak, bluejack, and blackjack growing on upland sites, are important alternate hosts. Water, willow, and laurel oaks, which grow along small streams throughout

⁴³ Its sweetpotato-shaped (fig. 46, E) or irregular cankers (on trunks, frequently with flattened or depressed (fig. 46, A and F), dead, often pitch-covered centers), and the tendency of its cankers to grow down along the branch into the trunk and to enlarge upon the trunk, usually distinguish fusiform rust from a much less serious rust caused by *Cronartium cerebrum* Hedgcock and Long. *C. cerebrum* is common on shortleaf, Virginia, sand, and spruce pines, and occurs on loblolly, and rarely on slash. Its cankers are always swollen globe galls, with distinct "collars" of bark both above and below the swelling, and are almost invariably confined to the region of original infection. *C. cerebrum* may kill or stunt some seedlings or small trees, but on large trees it commonly lives for years with little detriment to the pine. Its life history is closely similar to that of *C. fusiforme* (315).

⁴⁴ Save as specifically noted, the paragraphs on the rust caused by this fungus are based largely on unpublished memoranda and reports by Dr. Paul V. Siggers, U. S. Bureau of Plant Industry, Soils, and Agricultural Engineering.

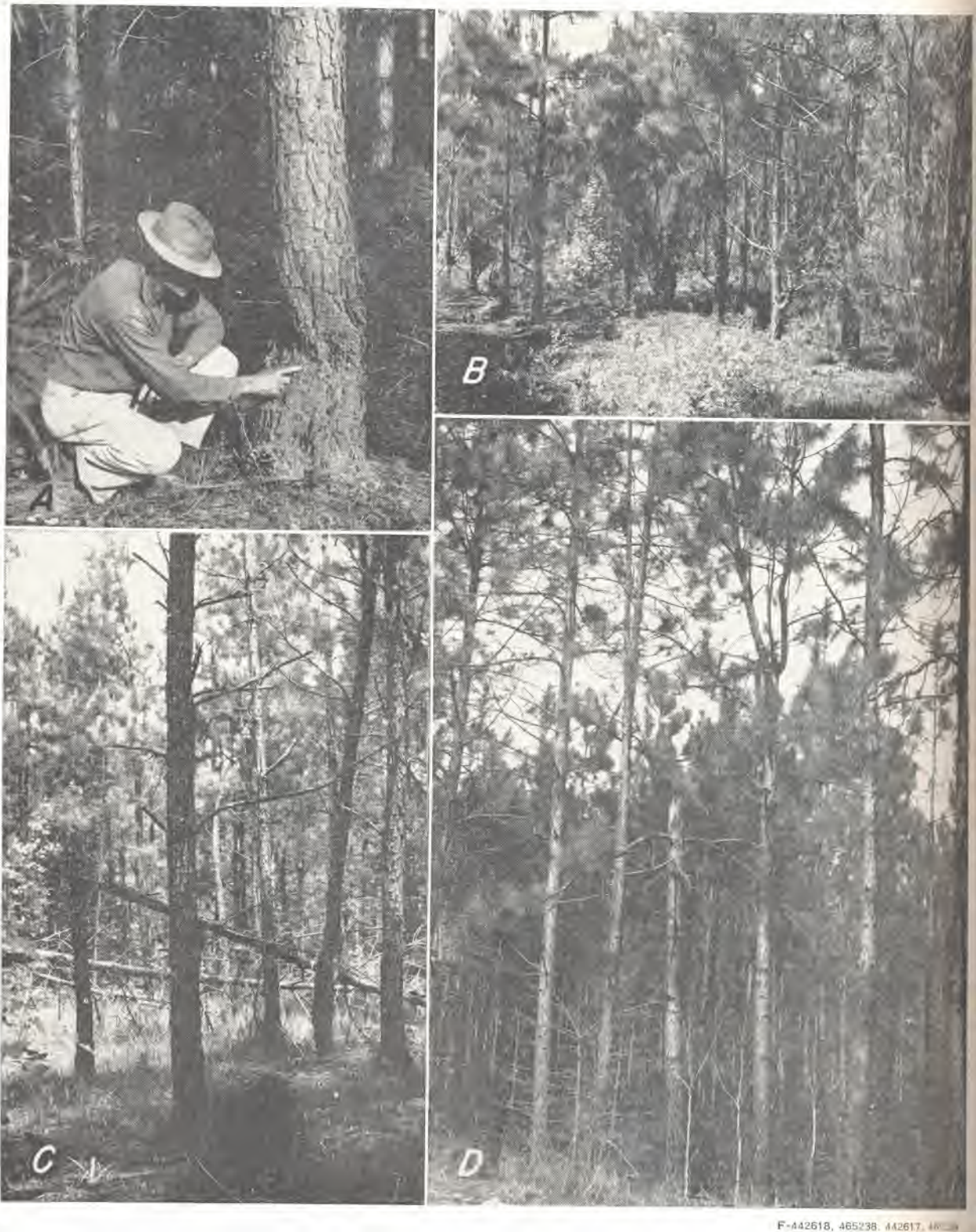

F-442618, 465238, 442617, 465239

FIGURE 46—Various stages of southern fusiform-rust infection and resulting damage on planted slash (A through E) and Harrison County, Miss., to Beauregard (A) and Rapides (C) Parishes, La



F-465240, 465241

planted and natural loblolly (*F* and *G*), and natural longleaf (*H*) pines, in various localities from Sumter County, Ala., (*E* and *G* courtesy Bureau of Plant Industry, Soils, and Agricultural Engineering.)

many of the pine types, are extremely susceptible and are a very important source of infection of the pines. The white oaks as a group, including post oaks, are the least important.

Infections on the oak result in multitudes of Yellowish spots on the lower side of the leaves. Within these spots are produced *urediospores*, which are capable of reinfesting oak leaves and forming new spots. They may very greatly increase the total number of spots on the oaks in a given year, thereby contributing indirectly to heavy infection of the pines. They do not, however, infect pines directly.

After a minimum of 7 to 10 days, *telia* are produced in tremendous quantities from around the bases of uredial fruiting bodies on the under sides of the oak leaves—both in the spots originating from urediospores and in those originating from aeciospores blown in from the pines. These telia are brown, bristlelike columns, sometimes one-tenth inch long, projecting downward from the leaf spots (fig. 26, **A**). They can be found in great numbers, often dozens and sometimes hundreds to a leaf, in April, May, and June.

The telia produce innumerable very small, thin-walled spores. These spores, the *sporidia*, become detached and are blown by the wind back to the pines, which they infect. Infection of pine can take place through the epidermis of newly germinated seedlings; this is the manner in which seedlings commonly become infected in the nursery. Larger pines may become infected through the epidermis of new shoots before the bark is formed, but most infection of planted pines is thought to pass into the twigs or stems through the needles. Infection takes place most easily in new needle tissue. Since new needle tissue is present both in needles just developing from elongating buds, and in needles of the previous year which are increasing in length at the base, infection occurs on stem wood of both the current and the previous year. In the Gulf States, the peak of pine infection is from about mid-April to mid-May, but infection may continue to some extent until at least the middle of June.

Infection of pines depends on the production of telia on the oaks and of sporidia on the telia, and on the dissemination of sporidia to and their germination on the pines. Once telia have formed on the oaks, abundant infection may take place on the pines whenever the temperature remains between 60° and 80° F. and the relative humidity remains at or very near 100 percent for at least 18 hours (655,657).

Susceptible pines are likely to suffer heavy (20 to 40 percent) or very heavy infection wherever there is a combination of (1) abundant oaks, especially of the more susceptible species, within 1 or 2 miles; (2) a March to June climate marked by 18-hour or longer periods of 60° to 80° F. temperature and essentially saturated atmosphere; and (3) even a light initial production of aeciospores, on natural or planted pines, to infect the oaks.

The second element in this combination is sometimes difficult to recognize in advance of planting, but frequently can be surmised or learned from weather records, and may be assumed if pines in the vicinity are heavily infected with rust, particularly if infection clearly has taken place in several different years.

Where the foregoing combination exists, or is likely to arise within 10 to 15 years after planting (as from gradual building up of oak thickets or of light infection in new pine plantations), the safest course is to plant the less easily killed loblolly instead of slash pine, or, better, to plant longleaf or shortleaf. If 10 percent or more of young longleaf pines near the planting site are infected with fusiform rust, it is better to plant longleaf than either slash or loblolly, because slash and loblolly are likely to be very severely damaged under conditions permitting such infection of longleaf. Eradicating the oaks to control fusiform rust in southern pine plantations, as currants and gooseberries are eradicated to control the closely related white pine blister rust, is impracticable.

Where the combination favorable to heavy infection already exists, the exact degree to which the pines become infected depends mainly on the abundance of new needle tissue during the production of sporidia on the oaks. Anything that causes the pines to elongate their buds and expose new needles (or to resume elongation of the previous year's needles) at an earlier date than usual is almost certain to increase infection.⁴⁵

Young pines elongate their buds considerably earlier than older ones—weeks earlier in some cases. In any given place and year, therefore, infection usually is most prevalent in 1- and 2-year-old plantations and progressively lighter in older ones. Geographic source of seed may affect date of bud elongation; Siggers has shown that the heavily infected trees of Georgia stock described in table 3 exposed new needle tissue earlier in the spring than the lightly infected trees of Louisiana stock.

Current or past cultivation or fertilization of the planting site similarly causes growth to start earlier in the spring and results in greatly increased rust infection (p. 168). Planted slash or loblolly pines should not be cultivated or fertilized in any locality in which southern fusiform-rust infection is appreciable.

Both earlier elongation of the buds and increased rust infection on the new growth of the main stems result from fire which partly defoliates but does not kill young planted slash pine. Similar increased infection (538) has occurred on planted loblolly pine partly defoliated by fire. Prescribed burning seems unlikely to increase in-

⁴⁵ Mere rapidity of growth after elongation has started has no such effect; see the faster height growth and lower infection of the Louisiana and Texas as compared with the Georgia stock in table 3, and consider the faster growth of 5-year-old trees as compared with that of the 1- and 2-year-old trees mentioned in the next paragraph.

fection on trees more, than 10 years old, however, and may be used for fuel reduction in stands of that age, without apprehension as to rust (658).

Fusiform-rust infection within 2 or 3 years after planting is not only heavier, but also more dangerous, especially to slash pine, than is later infection. Cankers affecting the main stem while it is still small are particularly likely to girdle it quickly and kill the tree. Trunk cankers on small trees are necessarily low down, where they will do the most harm even if the tree survives (fig. 46, B). Lastly, the side branches of very young trees are short enough so that infections even at their tips may run into the trunks.

Fusiform-rust cankers may be harmless as long as they remain confined to the branches. There is no evidence that such cankers reduce the growth of southern pines any more than, if as much as, branch cankers of white pine blister rust reduce the growth of western white pine (125). Branch cankers, however, especially on vigorous branches, grow toward the trunk at an average rate of about 3 and a maximum rate of 9 or more inches per year. Therefore any branch canker arising within a foot or 18 inches of the trunk (fig. 46, E) is likely to invade it, and even a canker originating 2 feet out may do so. Planting at somewhat closer than 6- by 6-foot spacing counteracts high fusiform-rust hazard not only by offsetting mortality and permitting wide choice of trees to leave in thinning (176), but also by shading many lower branches to death before the cankers on them grow into the trunks (477, 535, 658). Where percentage of trunk infection is low, ultimate losses from rust may be considerably reduced (particularly in young plantations spaced more widely than 6 by 6 feet) by pruning off (p. 172) side branches cankered within 12 to 18 or even 24 inches of the trunk. In extreme cases it may pay to prune in this way every year for several years, or in the winter following each spring highly favorable to infection (656). Such pruning is useless, however, on trees already infected in the trunk.

Even in plantations with a high percentage of trunk infection, judicious thinning (p. 171) will often salvage much merchantable wood.

Brown-spot needle blight, caused by *Soirrhia acicola* (Dearn.) Siggers, is a serious obstacle to planting as well as to natural reproduction of longleaf pine. It injures or kills part or all of the needles on trees up to 2 and occasionally up to 8 feet high. It occurs also on all the other principal and most of the minor southern pines, on southern pine hybrids, and on several exotics, from the Gulf States at least to Arkansas, Ohio, and North Carolina, and possibly to the northernmost ranges of loblolly and shortleaf pine (652). Infection is not, however, equally severe in all places (fig. 4), and the disease is rarely of economic importance except on longleaf.

Directly or indirectly, brown spot is the principal cause of the continuing mortality of longleaf pine during the 2d through the 10th to 20th

year after planting (fig. 8, p. 20); where uncontrolled, it has ruined large plantations. As has been shown both by records of infection classes determined at the start of the 4th growing season and by numerous experimental sprayings with fungicides, the disease greatly reduces the growth of seedlings which survive infection (figs. 47, 48, and 51), often to one-third and in extreme cases to one-twentieth of that of uninfected or lightly infected trees. Such delays in early height growth prolong the period of hazard from drought, vegetative competition, hogs, and the numerous other enemies of young longleaf, including brown spot itself. The disease, however, need be no such calamity as hog damage or several other ills. Ordinarily it does little harm to longleaf pines more than 18 inches high, and those above 30 inches high are safe from all but, the worst epidemics. Serious outbreaks in stands averaging less than 18 inches high can be recognized before they get out of hand, can usually be prevented or controlled at reasonable cost, and have been controlled on a large scale for many years. (165, 650, 651, 652, 653, 746, 750, 759, 794.)

Brown-spot infections of three different appearances are common: (1) Ordinary external spots; (2) external "bar spots;" and (3) internal killing of the needle tissue without distinct spots, but with yellowish flecks on the green part of the needle, followed quickly by yellowing and often finally by reddening or browning of the whole needle. The ordinary spots are straw yellow at first, later turning light brown, often with chestnut-brown borders when fruiting bodies form, or, in the fall, with dark purplish borders. Maximum length of a single spot is about one-eighth inch; it may or may not girdle the needle. The fruiting bodies

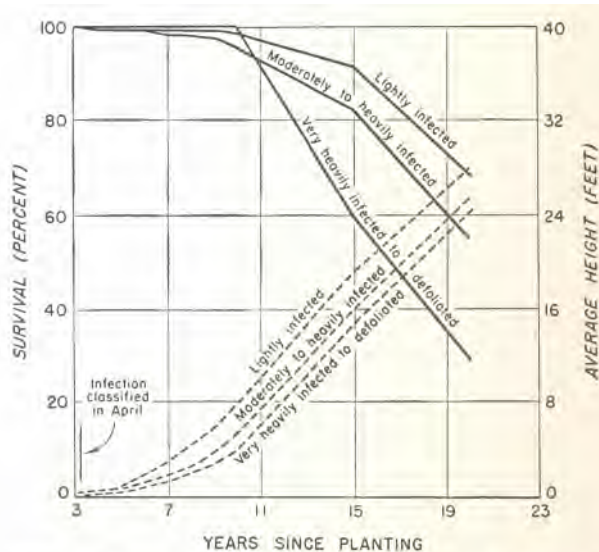

FIGURE 47.—Development of planted longleaf pine, unsprayed and unburned, at Bogalusa, La., by brown-spot infection classes determined at start of fourth growing season after planting. (Solid lines, survival percent based on trees alive when classified; dashed lines, average heights of survivors.)



F-465242

FIGURE 48.—Longleaf pine at Bogalusa, La., mostly stunted or killed by 15 years' uncontrolled brown-spot infection (row at left), and saved by semiannual spraying the first 2 years after planting (row at right).

appear as small, dark specks on the surface of the spot. Separate spots frequently run together, and eventually the needle tissue beyond and between groups of spots dies. Uninfected tissue shrinks more than do the spots, giving the dead needle a faintly mottled, embossed appearance. Bar spots begin as plain, amber-yellow bands encircling about one-eighth inch of the needle. Later, a circular, brownish spot about the size of a pinhead appears in the yellow band, usually remaining localized on one side of the needle, though sometimes encircling it. Both forms of spots have distinctly defined margins, a feature which distinguishes them from those caused by several other diseases. These two forms may appear at any season of the year. The interior infection that flecks, yellows, and kills the entire needle occurs in cool weather and usually is at a maximum from the first of March till the middle of April.

The fungus causing brown spot passes its life cycle entirely upon pines. Infection passes directly from one pine to another by ascospores or conidia.

Ascospores are produced in the winter and spring, usually if not always after the death of

most of the infected needle (652). They are not known to occur at other seasons, although observed patterns of infection suggest that they may do so. Ascospores are light, dry, and wind-borne. They characteristically cause light, scattered infections, sometimes at very great distances. They sometimes cause isolated spots on the foliage of tall trees, although by far the greatest part of all infection occurs within 18 to 30 inches of the ground. Ascospores are thought to be the principal means by which brown-spot infection invades nursery beds, plantations established with uninfected stock, and planted and natural stands freed of brown spot by burning.

Conidia may be produced by the fungus on diseased parts of still living needles at practically any time of year when two or more days of rain coincide with temperatures between 45° and 95° F. Apparently they may develop within 14 to 20 days of the initial infection of the needle. The conidia are produced in sticky masses. They are not wind-borne, except perhaps occasionally in water droplets, but are washed apart and splashed for short distances by rain. They carry infection to seedlings a few inches away (as in nursery beds) and possibly 2 or 3 feet (as to nursery stock planted close to occasional infected natural seedlings already on the planting site). They may be spread to considerable distances by animals or man, though this has not been proved. Principally, however, conidia intensify infection on seedlings already lightly infected. Under ordinary weather conditions and in the absence of direct control, infection in longleaf pine plantations established with uninfected or lightly infected stock may rise to averages of 14 to 25 percent within 6 months to a year after planting, of 30 to 77 percent within 2 years, and of 57 to 99 percent within 3 or 4 years. There is one record of a similarly rapid increase to 40 percent in the third year with loblolly pine, a species not ordinarily badly affected by brown spot (717).

Dangerous brown-spot infection of planted longleaf pine can usually be delayed and sometimes prevented altogether by spraying the stock in the nursery (pp. 93 and 97). Any appreciable number of infected natural seedlings present may, however, necessitate burning over the site before planting (p. 124) to get the full benefit of the nursery treatments.

Although spraying twice a year for 2 years may give feasible control of brown spot where infection builds up only moderately fast, spraying plantations often enough to control brown spot where infection rapidly becomes severe is too expensive for commercial use. Most incipient brown-spot epidemics on planted longleaf pine can, however, be controlled safely, effectively, and economically by prescribed burning (104, 105, 122, 141, 142, 165, 166, 169, 179, 227, 327, 338, 329, 423, 525, 650, 651, 652, 653, 660, 689, 746, 759, 794). The references just cited give details of technique, results, and costs for prescribed burning to control brown spot.

Costs usually include the loss of some seedlings from the fire itself, but in correctly timed and executed burns such losses usually are negligible in comparison with benefits.

The following are general guides in burning longleaf and mixed longleaf-slash pine plantations to control brown spot :

1. Prescribed burning ordinarily should be done in January or February unless local circumstances indicate that slightly earlier or later burning is preferable.

2. Burning should not be done at any fixed interval after planting—in the third winter, for example—but when and only when made necessary by the development of brown spot and rendered safe by the height and condition of the seedlings. An average foliage infection of or exceeding 35 percent—meaning that 35 percent of all the needle tissue produced during the current year is included in brown-spot lesions, dead needle-tips, and needles killed outright by the fungus (p. 166)—in December or late November indicates the need for burning the following January or February. Infection percentages of 12 to 20 percent in one winter often lead to more than 35 percent infection a year later, and give advance warning of the possible or probable need for firebreaks, allotments of funds for burning, and the like.

3. Longleaf seedlings $\frac{1}{7}$ foot to 4, 5, and even 6 feet high are much less able to resist fire than are seedlings which have not yet begun active height growth. This is particularly true of seedlings weakened by repeated heavy brown-spot infection (p. 167), and especially if they have large percentages of brown-spot-killed foliage at the time of the fire. The time to control brown spot by burning therefore is *before* any large percentage of the planted longleaf seedlings have begun height growth, and especially before the seedlings which have started growth have become weakened by the disease. Longleaf seedlings which have developed conspicuously tapering stems as a result of repeated brown-spot infection (fig. 50, p. 168) are likely to be killed by even light fires.

4. There is considerable evidence that, with proper care, longleaf pine seedlings one growing season in plantation may be prescribe-burned if necessary. Certainly, if longleaf plantations have become seriously infected during the second year after planting, it is far better to prescribe-burn them at the end of the second year than to wait till the end of the third. Postponing the fire one year means greater mortality from the brown spot, greater delay in height growth of the survivors, and more seedlings killed by the fire because they have started height growth or have been weakened by the disease.

5. Prescribed burns should be thorough enough to reach practically all infected seedlings, and hot enough to brown, though preferably not hot enough to consume, all needles as high up as infection extends on the seedlings. Light, patchy burns are ineffective in controlling brown spot.

6. The larger the area that is burned, the slower brown spot reinvasades, and the greater the benefits. Burns of 500 to 1,000 acres are none too large for most economical treatment and best effect. Smaller burns may be beneficial under certain circumstances, however, and it may sometimes be essential to prescribe-burn isolated longleaf plantations of an acre or less.

7. Under a variety of local circumstances, and chiefly where vigorous height growth is long delayed, a second or even a third prescribed burn may be necessary within 2 to 5 years to maintain the benefits of the first burn.

8. Slash-longleaf mixtures present a difficult problem in prescribed burning for brown-spot control. With care, however, slash pine can be prescribe-burned when 10, 6, or, in extreme cases, only 2 feet tall (407, 653, 660, 689). This at least leaves the way open for useful prescribed burning of mixed slash-longleaf plantations in which the longleaf needs, and can stand, burning in the third, fourth, or fifth winter after planting.

Needle cast, caused by *Hypoderma lethale* Dearn., attacks planted southern pines of all ages practically throughout their range, but has been reported most frequently from the Gulf States and on loblolly pine. Infection takes place directly from pine to pine, apparently in mid-summer on needles of the current year. The fungus attacks the needle tips first and progresses downward, turning the tissues light green or gray-green, and finally brown, until by the following spring at least 60 percent of the length of the needle is dead, or the whole needle has fallen. The disease does not cause definite spots as does the brown-spot organism, nor is the margin of infection sharply defined. *Hypoderma* produces black fruiting bodies on discolored portions of needles still green at the base. Heavy infection presumably reduces growth, but is not known to kill trees. Plantation spraying is not recommended, as outbreaks usually clear up spontaneously (110, 223).

Needle rusts of the genus *Coleosporium* infect planted southern pines, producing orange aeciospores in small but conspicuous white or pinkish fruiting bodies arising from small spots on the needles in the spring. They pass the rest of their life cycle on various herbaceous alternate hosts, usually composites. Their appearance on the pines is somewhat striking in years of abundant spore production, but so far as is known their effect is negligible, and no control is necessary or has been attempted. (110, 323, 577.)

Littleleaf, first reported in 1934-35, is a disease of shortleaf and to a lesser extent of loblolly pine. It occurs largely though not wholly in the Piedmont (fig. 4) and here it is the most important tree disease; it kills millions of dollars worth of pines annually, and constitutes one of the most serious silvicultural and economic problems in the southern pine region. (475, 683.)

Littleleaf presents an appearance of nutritional deficiency or of premature senility. Its most outstanding characteristic is a progressive annual shortening of twig growth, which makes the foliage look sparse. This is accompanied by abnormally short needles, yellowish rather than normally green needles, a falling off of diameter growth, dying of the crown from below upward, certain root abnormalities, and ultimately, death of the tree, sometimes in about 7 years, sometimes in much less. Neither cause nor control is known. On sites on which it occurs, littleleaf affects trees over 20 years and more than 3 inches in diameter, regardless of vigor, crown class, or position in the stand. (324, 351, 611.)

Littleleaf has not been reported in plantations, in all probability because few or no plantations in the littleleaf territory are old enough to be affected. The disease is serious, and caution is advised in planting pure shortleaf pine where there is any evidence of littleleaf. Planting loblolly may also be risky, but seems preferable to planting shortleaf. Slash and longleaf pine may be acceptable substitutes in some places. Early reports by investigators of littleleaf indicate that longleaf pine is infrequently affected by the disease.

Latest information concerning littleleaf is obtainable from the Southeastern Forest Experiment Station, U. S. Forest Service, Asheville, N. C.

Pitch canker has appeared on the leaders and branches, and occasionally on the main trunks, of Virginia, shortleaf, and pitch pines in North Carolina. A similar infection on slash pine in Georgia and Florida may be the same disease. The major symptom is a copious pitch flow on and below the canker. The canker retains the bark and is always sunken over the dead area. There is no dark, discolored wood as with *Atropellis* cankers, little or no swelling as with southern fusiform rust, and no visible fruiting as with either of these. Pitch canker kills quicker than fusiform rust. No control is known, except prompt pruning or removal of the diseased trees, which may stop local spread (326).

A *pine twig canker*, caused by *Atropellis tingens* Lohman and Cash, occurs on all the principal southern pines except longleaf, killing some of the twigs and forming targetlike, slowly growing perennial cankers on the larger branches and occasionally on the main stems. Saplings are most frequently affected. Freshly killed twigs retain their brown foliage conspicuously in the spring and early summer. Usually a persistent fascicle of dead needles is found in the center of the canker. The wood under the canker is stained bluish black. Small black fruiting bodies appearing irregularly over the canker turn green when placed in a 3 to 5 percent aqueous solution of potassium hydroxide, whereas those of other fungi remain brown or turn blue or purple. The dis-

ease, which seems to have been present for at least 50 years and to have done little harm at its worst, has seldom been reported since 1934. No control is recommended (110, 230).

Texas cotton root rot, caused by *Phymatotrichum omnivorum* (Shear) Duggar, is known to infect and kill loblolly pine planted on infected soils in Texas and southwestern Oklahoma (804), and, apparently, planted shortleaf in Oklahoma. It has not yet proved a serious obstacle to planting, and the fungus which causes it does not occur east of Texas and southwestern Arkansas. Infected trees die suddenly, with a typical darkening and wilting of the leaves. Diseased roots are badly rotted, and they and the soil in which the injury takes place often show the buff-colored, fuzzy mycelial strands characteristic of the fungus. Means of controlling it in plantations are not known.

Enlarged lenticels frequently occur on the lower stems and upper roots of small planted pines (especially slash) on excessively wet sites. These structures are enlargements of the cell masses around the normal "breathing pores" of the stems or roots, and appear as rough, reddish-brown protuberances, sometimes separate, round, and about the size of a pinhead, sometimes merging in groups that nearly encircle the root (223). So far as is known, they are harmless, though indicative of adverse growing conditions. Although they look much like fungus growths or fruiting bodies, they are not caused by a fungus. They may safely be ignored.

Chlorosis or yellowing, in a mild form, often occurs on planted southern pines of all species on very wet, dry, hot or otherwise adverse sites. It may affect all the needles simultaneously, or only the newest ones. It is caused by unfavorable environment, not by fungi, and is distinguishable from incipient brown spot by the uniformity of the yellowing, and from needle diseases in general by the lack of browning, of lesions on the needles, and of any form of fruiting bodies. It usually corrects itself with time or changes in weather or soil moisture. No treatment is recommended or known, except possibly mulching of seedlings on severely eroded sites.

REPLACEMENT PLANTING

When early survival falls much below that anticipated, final success may hinge on replanting the fail spots. The importance of such replacement planting has become increasingly evident with realization of how much initial survival varies from place to place and year to year, and with improvement in markets for pulpwood. Replacement planting of southern pines (except longleaf) may be ineffective, however, unless made within 1 or at most 2 years after the original planting.

Selecting Areas Needing Replacements

Whether replacement is desirable in any particular case depends to a great extent on the purpose of the plantation and on the total number of planted plus natural seedlings surviving per acre; to a lesser extent, on how the fail spots are distributed. As a rule, replacements are justifiable or essential at a higher level of survival in erosion-control plantations (580) than in plantations for timber production; in small, intensively managed plantations (as on farms) than in large extensively managed tracts; in widely spaced than in closely spaced plantations; and when mortality occurs in blocks and patches than when it is evenly distributed. Any contractual obligation to establish a certain minimum number of trees per acre may also necessitate replacement planting.

Region 8 of the U. S. Forest Service has considered replanting only where stocking has been found by careful reexamination to be below 100 well-spaced trees per acre in the Coastal Plain and 250 per acre in other parts of the Region (736). This is a somewhat arbitrary and unexact standard, but has worked well on the national forests because the planted areas have been large and the standard has concentrated attention on the worst failures instead of on debatable borderline cases. A minimum standard of 500 to 600 trees per acre has seemed acceptable in farm and industrial planting in Florida (194), and a minimum of 600 to 700 has been suggested for the Central, Piedmont, and Southern Appalachian regions (513).

After the level of stocking below which replacement is necessary has been decided upon, the next two problems are to identify the plantations or parts of plantations that need replanting, and to estimate the nursery stock and labor required. A third problem is to obtain better success in replanting than in the original planting, but the only precaution requiring special mention is to replant from a few inches to a foot or two away from spots where seedlings have died, instead of in the identical spots. Except for this, improved results depend mostly upon learning the causes of the original poor survival and modifying techniques to counteract them (pp. 122-139).

Classifying plantations as needing or not needing replacements is practically a repetition of the planting survey (p. 121). Estimating the stock needed usually is done simultaneously. Classification and the replacement planting itself differ from the original survey and planting mainly in requiring more careful timing. Except with longleaf pine, survivors of the original planting grow so rapidly in height that replanting fail spots after the second year usually is unsatisfactory. Effective classification of plantations for replacement therefore requires examination at or near the end of their second or, preferably, their

first growing season. The pattern of initial survival of southern pines other than longleaf (p. 18) fortunately makes such early examinations reasonably safe guides to replanting.

In plantations of less than 200 acres, any parts needing replanting usually can be found, and their areas estimated, by rather casual inspection. Systematic cruising methods employing maps and well-distributed samples (p. 122) are essential in most larger plantations and, if suitably intensified for small tracts, may be desirable on areas of 40 to 200 acres (504, 622). Straight or diagonal rows of seedlings staked at the time of planting have proved unsatisfactory guides to the need for replacements. Such rows almost never sample the whole plantation adequately. Furthermore, they include no natural seedlings and saplings, even though these may be numerous enough, in combination with surviving planted pines, to make replanting unnecessary.

When only a few acres require replanting, the number of seedlings needed can be estimated accurately enough by eye, or can be determined by actual count. On large areas a close estimate of the stock needed is more difficult to make, and may not be worth the cost of measuring exactly the area involved and the average number of fail spots per acre it contains. Here the usual practical solution is to order stock 10 or 20 percent in excess of roughly estimated needs, replant the least well stocked areas first and the best stocked last, and plant any surplus seedlings in new areas.

Replacements in Longleaf Plantations

The low visibility of longleaf seedlings during their characteristic delay in height growth, the variation in height growth from tree to tree when it does begin, and the peculiar susceptibility of longleaf to mortality after the first year (p. 5) make it more difficult to recognize longleaf plantations in need of replanting, to estimate stock needs, and to time reexaminations and replacements, than is the case with other southern pines. The feasibility of replanting with faster growing species is reduced in many instances by the possible need for later prescribed burning to control brown spot on the surviving longleaf. To offset these difficulties, fail spots in longleaf plantations can often be filled successfully after the second year, and irregular height growth makes stagnation of the stand unlikely even if the replacement planting results in some overcrowding.

These facts have the following practical effects on examinations of longleaf plantations to see whether replacements are needed. First, until after all the surviving seedlings have begun active height growth, it is necessary to examine individual seedlings closely, either throughout the plantation if it is small, or throughout many well-distributed sample plots if it is large; it is impos-

sible to judge the survival of such longleaf plantations by surveying them superficially. Second, a single reexamination at the end of the first growing season is not enough; the plantation must be reexamined every year or two until sufficient seedlings to make a satisfactory stand have grown beyond reach of hogs, brown spot, and other more localized hazards (fig. 4). Third and most important, each reexamination must show the vigor as well as the number of surviving longleaf seedlings. In some cases prescribed burning may be needed to improve vigor. In many others, not only the dead but also half or more of the non-vigorous seedlings will have to be replaced. Means of telling vigorous from nonvigorous seedlings are therefore essential.

Wahlenberg has noted that longleaf seedlings rarely or never begin height growth until they are 1 inch in diameter at the ground line (744, 746). Smaller seedlings may survive and eventually make height growth, and larger ones may succumb to brown spot or other injuries, but a ground-line diameter of 1 inch is a generally reliable and easily observed index to the imminence of height growth. It is particularly useful because it can be observed at any time of year.

From the first of December to the middle of January—even to the end of February in the northern part of the longleaf pine range and in the southern part when spring comes late—the form of the longleaf seedling bud is also a good index to the likelihood of early height growth. Buds may be classified as: (1) elongated—cylindrical, longer than thick, with pointed, conical tips, and covered with white scales; (2) round—little if any longer than thick, and covered with either hard and white or soft, feltlike brown scales; and (3) "pincushion" buds, consisting of flat disks or slightly convex masses of small, unopened needle sheaths or exposed, upward-pointing needle tips, with few or no discernible bud scales (570, 746).

Where brown-spot infection is moderate or light, seedlings with elongated buds are likely to make height growth within 2 years, often within 1. Seedlings with round buds may make height growth the coming season, but are much more likely to wait 2, 3, or more years—during which, of course, mishaps may occur. Seedlings with pincushion buds are extremely unlikely to make height growth within two or three seasons, and perhaps for much longer periods. These relationships seem to hold true regardless of the ages of the seedlings.

Where brown-spot infection is severe, seedlings with elongated buds still have good chances of beginning rapid height growth within 1 to 3 years, but seedlings with round or pincushion buds are likely to delay growth considerably longer than noted above, and many may die. Figure 49 shows the survival and height growth of longleaf seedlings in an area of severe brown-spot infection at Bogalusa, La., through the 15th year after plant-

ing, by bud classes determined in February preceding the 5th growing season. Data taken 20 years after planting showed that none of the seedlings with elongated buds, a few with round buds, and about half of the survivors of the pincushion-bud class had died between the 15th and 20th years.

The degree of brown-spot infection alone, regardless of seedling bud class or ground-line diameter, gives a good idea whether vigor will be maintained or increased or is about to decrease. In describing infection of individual seedlings, the total needle length in brown-spot lesions, brown-spot-killed tips, and needles killed outright by brown spot (including those which have dropped off), is expressed as a percentage of the total length of all needles produced during the current year. With a little practice this percentage can be estimated accurately enough by eye. Infection rates for plantations are determined by averaging the estimated infection percents of random samples of 100 or more seedlings.

The lighter the infection, the better survival will be and the sooner active height growth may be expected. In general, seedlings with 50 percent or more of their total needle length in lesions of dead tissue are likely to decline in vigor; other levels of infection are discussed on page 163. Estimates of infection made about December seem to give the most reliable forecasts of survival and growth. Sudden increases in the percentages of dead tissue about March or April sometimes makes spring estimates misleading, and continual development of new needles and occurrence of new infection throughout the growing season may also be confusing. At any time of year, however, the general degree of infection is useful in predicting probable future vigor.

Another index to vigor is the number of needles per bundle or sheath. Although longleaf is a "three-needled" pine, the secondary needles formed during the first year—as in the nursery—are predominantly in twos. Under favorable conditions, and particularly after active height growth begins, most needles formed after the first year are in threes. On adverse sites, however, apparently in drought years, often after fires or defoliation by insects, and very frequently after repeated and severe brown-spot infection, seedlings up to a foot or more high form part or all of their new needles in twos. The more serious the loss of vigor, the higher the percentage of two-needled fascicles is likely to be, particularly on the smaller seedlings. The last needles formed by seedlings about to die from brown spot or other injuries frequently are of juvenile form, bluish green in color, and single instead of in bundles (746).

As needles can be observed the year round except right after fires, these relationships make the numbers of two-needled and three-needled bundles a useful supplement to other methods of judging

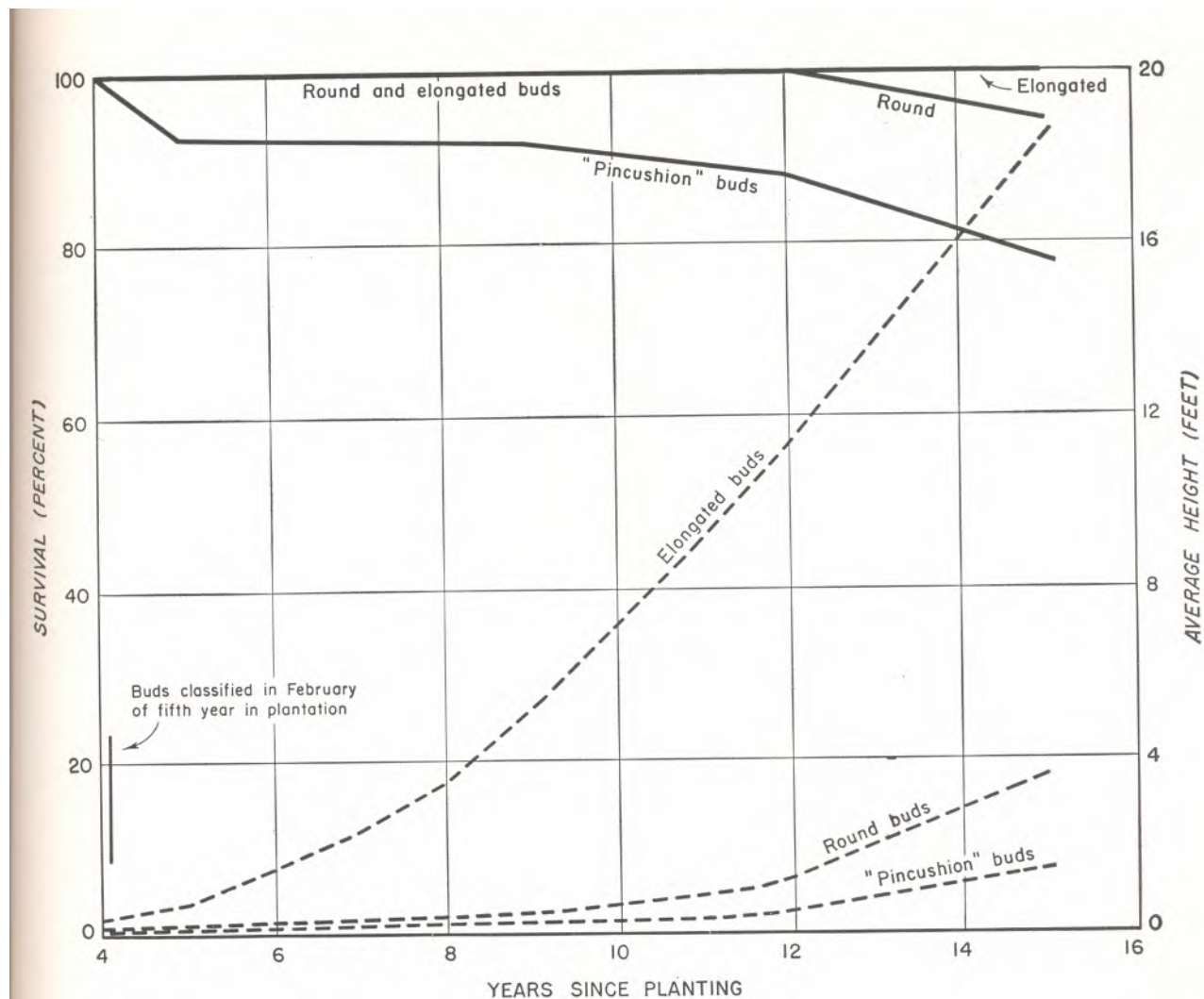

FIGURE 49.—Development, by bud classes, of planted longleaf pine, Bogalusa, La. (Solid lines, survival percent based on trees alive at start of fifth year in plantation ; dashed lines, average heights of survivors).

vigor. In particular, a higher percentage of three-needled bundles in the newest than in the older foliage indicates increasing vigor, while a lower percentage in the newest foliage shows that vigor is declining and that the seedling may have to be replaced if growing conditions do not markedly improve.

Before they die outright from repeated, heavy brown-spot infection, longleaf seedlings from about 3 inches to 3 feet high usually show 1 of 2 characteristic symptoms of declining vigor. Either they die back from the top and form bunches of weak, two-needled or juvenile foliage along the sides and at the base, or (fig. 50) their tips remain alive but grow progressively less in height and diameter each year, forming conspicuously tapering instead of nearly cylindrical stems. When longleaf seedlings that have started height growth develop either of these symptoms, there is little hope for them. Prescribed burning to reduce the brown spot is likely to be worse than useless, because seedlings of these height classes, and

seriously weakened by disease, are very easily killed by fire. Such weakened longleaf seedlings should be replaced in replanting operations, setting the new seedlings about 2 feet from the weakened old ones both to decrease infection of the new from the old and to reduce competition if the old seedlings happen to recover.

In examining longleaf plantations for replanting, it is suggested that, to be classified as thrifty, any longleaf seedling present (whether planted or natural) should have :

Less than 50 percent brown-spot infection.

In November or December through mid-January and possibly February a round—preferably white—or elongated bud.

More three-needled than two-needled bundles, and especially a higher percentage of three-needled bundles in the newer than in the older foliage.

If more than 3 and particularly if more than 5 years in plantation, a ground-line diameter of at least 1 inch. Seedlings less than 3 years in

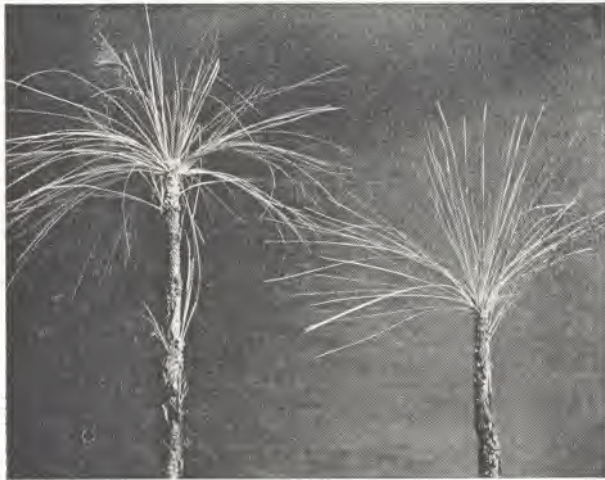

F-465243

FIGURE 50.—Tapering stems, poor current height growth (shown by bark rings), and meager foliage of longleaf pine seedlings after repeated heavy brown-spot infections. Such seedlings are likely to die of prescribed burning and unlikely to recover without it; in replanting, they ordinarily should be replaced.

plantation may have smaller diameters and still be classed as thrifty on other evidence.

e. No killing from the top downward and no conspicuous taper in the top of the stem as a result of repeated defoliation by brown spot.

If the plantation is young, the seedlings are small, and brown-spot infection has been heavy for only 1 year, prescribed burning should salvage half or more of the unthrifty seedlings. In older plantations, prescribed burning may not be feasible and up to 90 percent of the unthrifty seedlings may have to be replaced. When either brown-spot control or replanting is clearly needed, it should be carried out at the earliest appropriate time; temporizing with either may result in serious losses. Only when examination shows enough thrifty seedlings to make an adequate stand, or when neither improvement nor deterioration can be predicted reliably, should action be postponed until after a later reexamination.

Except where an important fraction of the stand has lost its resistance to fire as a result of combined brown-spot infection and height growth, there is much to be said for prescribe-burning pure longleaf pine plantations before replanting them (166). On large operations, where plans for replanting must be made months in advance, it may pay to burn a year before replanting. On smaller areas, burning, then reexamining, and then replanting, all in the same winter, usually is preferable. Burning makes small, surviving longleaf seedlings very much easier to see. It reduces brown-spot infection on the established seedlings, and reduces the chances of its spreading to longleaf replacements. It postpones the need for later

prescribed burns and may make them unnecessary; in the latter case, it makes possible the replacement of longleaf with other species.

FERTILIZING AND CULTIVATING PLANTATIONS

With the possible exception of fertilizing longleaf pine to make it start height growth promptly—a technique not yet developed to the point of practicality—fertilizing and cultivating southern pines do not, in the light of present knowledge, warrant recommendation.

In most tests these practices have reduced survival, chiefly by increasing fungus infection and sometimes (in the case of fertilizing) by stimulating an excess growth of weeds around the planted trees. They have improved growth more often than survival, but apparently in no instance enough to repay the cost of treatment. There is also considerable evidence that increases in growth rate resulting from cultivation and fertilization may seriously reduce the quality of the products from the trees. Tests with other American pines and in Europe confirm these results, and suggest the inadvisability of fertilizing plantations unless a radical nutrient deficiency has been clearly demonstrated. (74, 106, 207, 210, 214, 215, 228, 083, 321, 322, 332, 378, 379, 471, 570, 572, 707, 790.)

Planted slash pine should not be fertilized or cultivated where southern fusiform rust is an appreciable plantation problem, because either practice, or even planting on recently abandoned fields, has rather consistently doubled rust infection of this species (106). Even in Texas, well outside the heaviest rust zone (fig. 4), cultivation of slash pine has resulted in half again more infection (74). Although there is less evidence of this effect with loblolly, there is still enough to indicate similar danger in these practices, and both natural and planted old-field loblolly stands in zones of high rust hazard are notoriously likely to be heavily infected. The heavier infection of both species following fertilization or cultivation is attributed to an earlier resumption of growth in the spring by treated than by untreated trees.

In a number of studies of cultivation and fertilization, the most effective treatment for increasing growth of longleaf pine was the complete removal of grass by hoeing (570, 572). Hoeing succeeded, however, only where brown spot was held in check by spraying the seedlings several times a year with Bordeaux mixture or other suitable fungicides until they were tall enough to escape the disease. In a later and more comprehensive study, spraying increased both growth and survival more than did any combination of hoeing and fertilization (fig. 51). It doubled or tripled survival. It increased height growth over that of unsprayed seedlings by 68 to 212 percent on hoed areas, and by 47 percent in the unmodified rough. Hoeing increased height growth substantially (more with-

out fertilizer than with it) when seedlings were sprayed. When seedlings were hoed but *not* sprayed (unfertilized, denuded check, fig. 51), the hoeing appreciably reduced height growth, largely because it increased infection by brown spot.

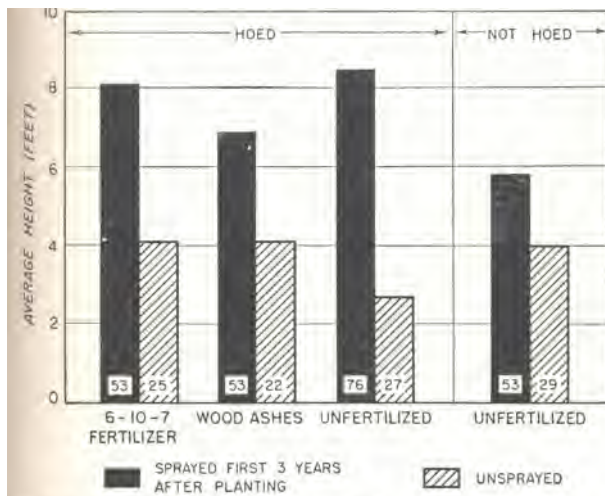

FIGURE 51.—Heights and survivals of variously hoed, fertilized, and sprayed longleaf pines, 7 years after planting. (Figures within bars are survival percents.)

When spraying has been omitted (in localities of brown-spot hazard), hoeing around longleaf seedlings has invariably caused a manifold increase in brown-spot infection. The intensified infection has done more harm than the hoeing has good; not infrequently it has killed the seedlings.

Hoeing planted longleaf pine in severe brown-spot areas without spraying cannot be recommended. Hoeing with spraying added seems prohibitively expensive.

THINNING AND PRUNING

With plantations, as with natural stands, "the ultimate total yield (including thinnings) depends on the timeliness and suitability of a series of thinnings—not on just one thinning. Within reasonable limits, single thinnings that are a little too early or too late, or a little too heavy or too light, do not give very poor results unless the same errors are repeated. If made much too late or much too early, however, the first thinning will undoubtedly reduce the eventual total yield. Hence, it is very important to make a good start. It is also important to realize that a good first thinning is not enough in itself to insure high yields, and that further thinnings must be both timely and of suitable intensity to make the most of a good start" (136).

It is not the purpose of this bulletin to guide management beyond the first thinning, which breaks up regular plantation spacing and leaves a stand essentially like that in a well-stock, well-

managed natural forest.⁴⁶ The first plantation thinning ordinarily should pay for itself out of products, or even yields a profit; precommercial thinning is unnecessary except when spacing has been too close or survival very much greater than anticipated. The principal practical problems involved in the first thinning are when to make it, how much of a stand to leave, how the trees left should be spaced and arranged, and which individual trees to leave and which to cut. Like all thinnings, the first must be made with care to avoid *Ips* damage (p. 156), and the trees to be removed should be marked in advance.

Time of First Thinning

Southern pines planted even at the closer spacings recommended on pages 18 to 22 do not need or justify thinning before the 13th to 15th year unless stagnation threatens" Longleaf at any of the recommended spacings and the other southern pines at the wider spacings suggested, even if survival is high, ordinarily should not need thinning before the 18th to 20th year. Plantations with only fair survival may not need thinning until the 25th year unless the surviving trees are in distinct patches instead of uniformly distributed. (135, 136, 137, 256, 293, 395, 537, 765, 766, 810.)

Except when there is immediate danger of stagnation, no great importance should be attached to thinning the first year that merchantable products can be obtained. Ordinarily, no part of a southern pine plantation should be thinned until the trees within it have fully occupied the ground, closed their crowns, and begun self-pruning. The wider the spacing and the lower the survival, the later planted trees will reach this stage. Furthermore, in stands ranging from 5 to about 11 inches d. b. h., yields and quality of products both from thinnings and final cuts may be increased, and costs per unit volume thinned decreased, with each inch in diameter that the trees are allowed to grow before being thinned (537).

With optimum spacing, survival, and growth, need for the first thinning coincides with attainment of economical diameter for pulpwood production and with dying of lower branches of dominant and codominant trees to a height of about 35 feet; this combination should assure the maximum yield of high-quality products in the final cut. Thinning as soon as salable products can be cut may, however, be desirable to salvage

⁴⁶ A more complete treatment of thinning in general and of thinning southern pine in particular is given in the literature (63, 98, 130, 135, 136, 137, 138, 170, 172, 256, 267, 268, 310, 316, 342, 372, 430, 478, 537, 591, 746, 765, 766).

⁴⁷ The earliest evidence of stagnation (310) is, in southern pine plantations, a sharp decrease in diameter growth. This is followed shortly by a reduction of the live crowns of dominant and codominant trees to less than 35 percent of the total height, and eventually by the death of merchantable or near-merchantable trees from competition.

infected or injured trees, or, by leaving only the sturdier dominant trees, to reduce the danger of future ice damage (217, 371, 425, 528). Despite the debris left on the ground, early thinning also appears to reduce injury from subsequent fires (738).

How Much of a Stand to Leave

In thinning a southern pine plantation for the first time, it is much more important to leave the right stand per acre than to obtain any particular yield from the thinning.

Enough trees should be left to shade the ground fairly well. There should be no attempt to reduce the stand so much at the first thinning that the trees will reach final sawlog size without further thinnings ; like excessively wide spacing, such heavy initial thinning wastes growing space, lowers the quality of products, and lets undesirable species invade the stand. The trees left after thinning should be able to close the crown canopy and fully occupy the site in from 5 to at most 10 years. On the other hand, they should be far enough apart so that it will take at least 3 years and often preferably 5 years (5.37) for their crowns to grow together. Cutting less heavily than this not only reduces the yield from the first thinning, but may fail to maintain desirably rapid, uniform growth by the trees left.

To meet these specifications, the stand left must ordinarily be reduced to 200 to 800 trees per acre. In stands just reaching pulpwood size, however, 200 may be too few (293), and in farm plantings first thinned for pine kindling or small fence posts, it may be preferable to leave 1,000. Where trees have been planted at 6 by 8 spacing and have survived 50 percent or better, one pulp company has found the removal of 30 percent of trees, by count, in 13- to 20-year old stands, and 40 percent in 21- to 25-year old stands, a safeguard against both under- and over-thinning. In such stands, these rules leave about 300 to 550 and 270 to 460 trees per acre, respectively. In plantations spaced 6 by 6 and especially 5 by 5 feet, however, they leave far more trees, and result in underthinning. Bull recommends thinning natural slash pine stands to 400 to 800 trees per acre if the dominant and codominant trees average 4 inches d. b. h. or 30 feet high ; to 300 to 600 if the dominants and codominants average 5 inches d. b. h. or 30 to 40 feet high ; and to 200 to 400 if the dominants and codominants average 6 to 8 inches d. b. h. or 40 to 50 feet high (136).

On average sites, the first thinning of loblolly pines planted at any moderately reasonable spacing and with fair to good survival should reduce the basal areas per acre of stands with average breast-high diameters of 4, 5, 6, 7, 8, and 9 inches *at least* as low as 96, 105, 111, 116, 120, and 125 square feet, respectively, but not less than 60, 68, 73, 77, 80, and 84 square feet, respectively (766). On average sites, more trees and larger basal areas

per acre may and should be left with slash than with loblolly pine, and with longleaf pine than with either loblolly or slash (168, 766), at least at the younger ages. Slightly heavier stands should perhaps be left on very good sites, but lighter ones should be left on poor sites.

More elaborate guides (220, 589, 631) than the foregoing, although useful in developing and evaluating specifications for thinning under particular circumstances, are of little direct help in plantations. Because of the regular spacing of the planted trees, the "D 6" and related rules (61, 257, 451, 517, 527, 796) are less useful in thinning plantations for the first time than in thinning natural stands.

Arrangement of Trees Left

Ordinarily, the more uniformly spaced the trees are after thinning, the better. No large openings should be made. Trees bordering existing openings should be left to extend their branches and roots into them. When several crooked or rust-infected trees occur together, the least severely injured should be left to utilize the soil and light.

In thinning extensive plantations of northern species for the first time, the difficulties of low value of products and high cost of marking have been overcome, without seriously affecting the stands left, by removing all trees in every third or fifth row, together with suitable numbers of the poorest trees in intervening rows (435, 688). Such row thinning appreciably reduces the total costs of both marking and cutting per unit volume removed. In certain loblolly pine plantations in the Duke Forest, Durham, N. C., all the trees in every eighth row, together with the poorest trees in the intervening rows, have been cut in the first thinning. This permits removing the fourth row of seven and the middle row of three, together with the poorest trees in all other rows, in the second and third thinnings, respectively.

Choice of Trees to Leave and to Cut

Because of the uniform initial spacing of the planted trees, the first thinning in a plantation usually requires less attention to distance between trees than does thinning in a natural stand. It gives correspondingly greater opportunity for leaving trees with superior stems and crowns.

What constitutes superior stem and crown quality will vary considerably with the purpose of planting. Straightness of trunk, superior height, good clear length, and small branches that will leave small knots are at a premium in trees to be left for saw timber, poles, and piling. Good diameter growth is desirable in such trees, but very rapid diameter growth may result in too few rings per radial inch to meet density specifications for these products. In plantations established for pulpwood only, maximum diameter growth may

be most important, small branches less important, and straightness unimportant. In plantations established for naval stores production, the best trees to leave usually are those with rapid diameter growth and long, full crowns.

Where rust infection, wind damage, ice damage, and the like are not excessive, all seriously infected and otherwise injured trees may be cut in the first thinning, if of merchantable size. Where injuries are extensive, the removal of all injured trees may leave too few stems or too little basal area per acre. Under such circumstances, freshly killed trees and trees obviously about to die should be cut if merchantable, as should very crooked trees or trees forked within the first or second log unless their removal will leave an excessive gap. Less crooked trees may be left unless their removal is desirable to make space for better trees. Trees with rust cankers on the trunk should be removed before those with cankers on the branches only; those with several trunk cankers before those with one; those with cankers running more than half-way round the trunk, or with deeply sunken cankers, or with a bend at the canker, before more lightly cankered individuals; those with low cankers before those with cankers high up. Among trees with branch cankers only, those with cankers within 15 inches of the trunk should be removed before those with cankers farther out (424, 425). Among wind- and ice-damaged trees, the worst bent or broken should be removed first; those most likely to regain vigor and to increase in volume and value of products should be left. Ice-damaged trees which have straightened up except for a slight curve at the base should, however, be removed as early as full use of the site permits, because the process of straightening depends on the formation of low-grade compression wood.

Excessively wide-crowned, thick-branched trees that prune themselves poorly should be removed, so far as is possible, in the first thinning, to prevent their wasting growing space. This is particularly true of loblolly pine. An exception occurs in longleaf pine plantations, in which the largest branched, widest crowned trees are likely to owe their shape to early height growth, possibly from hereditary brown-spot resistance, rather than to hereditary limbiness. Therefore, all but the very roughest of such planted longleaf trees should be left in the first thinning, even if they must be pruned.

It is questionable practice with any of the southern pines to remove the largest trees for the sake of increasing yields or labor output in early thinnings, and to leave the smallest and slowest growing trees to serve as the parents of the trees in the next rotation (427). Where ice storms occur, such thinning from above may also greatly increase ice damage (p. 149).

Whether to cut or leave small trees not competing seriously with larger trees that will be left is sometimes a puzzling question (63, 172, 310). If

they will not directly repay the cost of cutting, they should ordinarily be left; their natural death will remove them. If they live they may help clear the trunks of neighboring trees, and may eventually grow to merchantable size. If, however, they are already large enough to pay their way, cutting them will increase the returns from the first thinning.

Pruning

Although longleaf and especially slash pines prune themselves well in reasonably close stands (484) and even loblolly and shortleaf prune themselves better than the pines most frequently planted in the North (377), there is considerable evidence that pruning selected trees may greatly increase the profits from southern pines planted to produce saw timber (133, 311, 411, 484, 560, 561, 685, 746). Need for and returns from pruning will be greatest in plantations at wide spacing or with poor survival, or where longleaf has started height growth irregularly. Need and returns may be negligible, especially with slash pine, where spacing is close and survival good. Pruning to improve sawlog quality may, however, intensify ice damage, and should be undertaken cautiously in localities where ice storms are common.

In addition to its use for improving saw timber by reducing knots, pruning may be helpful in controlling southern fusiform rust on slash and loblolly pines, and in clearing the trunks of widely spaced longleaf and perhaps of slash for early production of naval stores.

To pay for itself, pruning for sawlog improvement must be done at a time when it will confine knots to a central core of the trunk not more than 4 or at most 5 inches in diameter, and while the branches are still not more than 1 inch to at most 2 1/2 inches thick.⁴⁸

This means pruning when the trees are small, perhaps first to a height of 7 or 8 feet, and then (about 5 years later) to 17 feet. To be effective, pruning may have to start several years before thinning, though pruning to the top of the first 16-foot log may often be combined advantageously with the first thinning. Trees may be pruned to a height of 1 1/2 to 2 logs, but pruning to a height of 1 log seems to offer the best returns (133, 410, 484, 560).

For pruning to 7 or 8 feet, handsaws or close-cutting pruning shears give best results; axes, ordinary pruning shears, and clubs have proved much less satisfactory. For pruning to heights

⁴⁸ A variation that shows some promise is annual removal of all buds and summer side branches above the 2 1/2-foot level, beginning when the trees are 3 to 5 feet high, and carrying the process to a total height of about 10 feet (615). Although the possibilities of this method have been little explored in the southern pine region, the longleaf pines in fig. 3 were completely bud-pruned to about 20 feet, and grew rapidly to that height with no needles except those on the main stems.

of 17 feet, handsaws used from 12-foot ladders, or saws on 9- to 12- or 14-foot poles, are about equally satisfactory, with perhaps a slight advantage in favor of the pole saws. For pruning above 17 feet, special pole saws seem superior (131, 133, 216, 274, 312, 364, 410, 484, 496, 526). A power pruning saw, and an ingenious "push-pull" pruner effective on limbs up to 1 inch in diameter, have been described (211, 592), but have not come into general use.

Handsaws with straight or slightly curved blades 12 to 16 inches long and 5 to 8 teeth per inch of blade, and cutting on both strokes or on the pull stroke only, have been found satisfactory. The teeth should be long and acute, and the blade very stiff—preferably stiffer than the saws ordinarily sold for orchard pruning. Blades cutting on the pull stroke only and firmly attached to poles, but otherwise like those just described, have proved best for pruning above 7 or 8 feet. The angle of attachment should be adjustable. The poles must be light, but rigid enough to avoid springiness (131, 410, 484). Aluminum or other light metal tubing makes the ideal pole.

With both hand and pole saws, pruning starts at the lowest branch to be cut, and progresses upward. In pruning to 17 feet at one operation, some such combination as one man with a hand saw to prune branches up to 8 feet, and two with pole saws to prune the rest, works best. With longleaf, such pruning has average 3 man-minutes per 4-inch tree, 4½ per 6-inch tree, and 6¾ minutes per 8-inch tree, including walking time from tree to tree (131).

There is no appreciable effect on growth of southern pines if the lower one-third of the living crown is removed at one operation. Removing more than one-third of the live crown may reduce diameter growth somewhat. There is evidence, however, that it reduces diameter growth more at breast height than higher up, and so improves the form of the trees, as Stone has reported in the case of fire (131, 133, 208, 230, 395, 484, 702). Similar results have been obtained with other species, although some of them react less favorably than the principal southern pines to removal of ⅓ to ½ of the live crown (77, 78, 125, 233, 318, 462, 464, 692).

Cutting both dead and living branches flush with the trunk is imperative, as stubs, even short ones, delay healing and may permit decay. The cut should be close enough to involve the slight swelling surrounding the base of the branch; cutting into this swelling increases the size of the wound but makes it heal faster and more smoothly (484).

Since pruning improves the quality of sawlogs and veneer bolts only when several inches of clear wood have been laid on over the knotty central core, it is footless to prune trees too weak, crooked, or defective to make sawlogs or bolts.

It is also wasteful to prune trees so numerous or so closely spaced that many of them must be cut for pulpwood, ties, small poles, or small rough lumber before they attain diameters large enough to pay dividends on the cost of pruning. Some allowance in number, perhaps 20 percent (313, 432), should be made for infection, storm damage, and other accidents to pruned trees, of course, and for errors in judgment as to which trees will be left to form the final stand. Mattoon and others recommend pruning 150 to 300 trees per acre in young stands (410, 484), but, assuming a maximum of about 100 trees per acre at final sawlog harvest, 200 trees per acre seems the absolute maximum it would pay to prune in southern pine plantations. From 120 to 150 uniformly distributed trees of good form and vigor should be ample in most cases. To maintain uniform growth by and to insure maximum returns from the pruned trees, plantations should be thinned at fairly regular intervals after pruning for sawlog improvement.

Since profits from pruning may easily be wiped out by treating too many trees, or trees of inferior quality, it usually pays to paint-mark, in advance, the trees to be pruned. For pruning with untrained, unsupervised labor, it sometimes pays to prune all trees in every third row to a height of 7 feet, then have a qualified man go up and down the paths cleared in this manner and paint-mark suitable trees in all rows for pruning to greater heights (202).

Pruning off cankered branches to control fusiform rust by preventing infection of trunks (p. 161) usually must be done separately from pruning to improve sawlog quality. To be effective, rust-control pruning usually must be done earlier, and may have to be repeated annually for as many as 5 years. Occasionally it may be included in a routine pruning to 17 feet, and sometimes it may pay to prune potential sawlog trees cleanly to 7 or 8 feet in the course of a rust-control pruning. Rust-control pruning will be most effective at least cost if all live branches cankered within 24 inches of the trunk are removed, and no other branches are cut. (Cankers on dead branches are harmless.) Evidence from several sources indicates that such pruning will seldom reduce growth (133, 230, 318, 395, 484).

Although winter is the best time, southern pines apparently can be pruned safely at any time of the year except during extreme summer drought (484).

SUMMARY OF IMPORTANT POINTS

GENERAL POLICIES

The four principal southern pines differ greatly in habit, growth rate, adaptability to site, and resistance to fire, animals, insects, and disease. Planting sites vary greatly in climate, soil, and the presence or intensity of insects, diseases, and other hazards. These things being so, correct choice of species for site is a necessary foundation for and a long step toward success. On many sites a mixture of species gives more promise than planting one species in pure stands.

Obtaining seed from the right geographic source has been shown to be vitally important with loblolly pine and may be important with other species as well. Wherever feasible, seed should be collected within a hundred miles of the planting site, certainly in a locality with a climate essentially identical with that of the planting site. Always the geographic source of the seed should be made part of the planting record.

Because of increasingly close utilization throughout the South, and to allow for mortality, planting should generally be at close spacing. Close spacing minimizes trouble with southern fusiform rust. Spacings at least as close as 8 by 8 or 6 by 8, and preferably of 6 by 6 feet are recommended, with a minimum of 5 by 5 for all species on farms, and for longleaf anywhere.

Direct seeding of southern pines has proved un dependable, and often expensive. Pending demonstration of improved methods, it can be recommended only as a supplement to planting nursery seedlings, or as a gamble where severely burned-over areas must be restocked quickly with pine to forestall hardwood brush. Seed of high germination percent, and site preparation or other means to discourage birds and rodents and to insure protection against drought, appear to be among the essentials to success.

Planting costs vary so much that only those the nurseryman or planter obtains from the records of his own operations are likely to be directly helpful. Adequate records, not only of costs but also of all important points in the planting process and of local tests and innovations, are one of the surest ways of attaining good results and low costs, particularly on large operations.

SEED

Southern pines produce seed irregularly. In large operations particularly, annual estimates of cone crops are essential to economical collection, and the collection and storage of surpluses in good seed years is essential not only to reasonably low

seed costs but often to any production of stock when seed crops are poor.

Southern pine cones are not mature, and should not be collected, until they will float in SAE 20 lubricating oil immediately after picking from the standing tree. Collection is cheaper from felled than from standing trees, but care must be taken not to collect from trees felled before maturity of the cones. Except in years of desperate seed shortage, wormy cones should not be collected. Needles and other trash are most cheaply removed at the collecting ground. Cones should be shipped promptly. They should never be kept in sacks more than 1 week. They may be precured most effectively in layers two cones deep, but for either air or kiln drying to extract the seed, single layers are best. Maximum temperatures recommended for drying by artificial heat are 115° F. for longleaf and 120° to 130° for other southern pines.

Dewinging, cleaning, and drying have been prolific sources of injury to southern pine seed, and should be planned, controlled, and checked with particular care.

Seed should be extracted as soon as possible after collection and placed immediately in dry, cold storage, not held at air temperature till spring. Even over winter, southern pine seed (especially longleaf) keeps best at a seed moisture content just below 10 percent (based on oven-dry weight of the seed), and at temperatures below 41° and preferably below freezing, to as low as 5°.

Stratification of seed by chilling it in contact with moist sawdust, sand, or granulated peat is essential to prompt, complete germination of some lots of seed, unessential to others. Ordinarily, it should be applied only when advance germination tests show the need for it. Chilling for more than 10 to 20 days may be unnecessary; chilling for more than 45 days is risky with lots weighing more than 5 pounds. Temperatures should be below 41° F., but must not be below freezing.

Germination tests are essential to control seed processing and supply in general, and to economical use of seed and control of seedbed density in particular. In testing, the drawing of a sample truly representative of the seed lot is as important as germination technique. To germinate, many seed lots require some light during daylight hours (seeds tested in sand should never be covered more than one-eighth inch deep), but direct sunlight may injure or kill seed germinating indoors. Longleaf seed germinates abnormally, if at all, if temperatures rise above 80° F.

NURSERY PRACTICES

Choice of nursery site has a major influence on the cost and success of the whole planting operation. It particularly affects cost of producing seedlings, physiological quality of stock, and the degree to which the nursery seedlings are affected by diseases such as fusiform rust and brown spot.

The larger the nursery production, the lower the cost per thousand trees for modern equipment and professional supervision. The higher the degree of mechanization, including chemical weeding, the lower the cost per thousand trees shipped, except from extremely small nurseries.

Nurseries are highly individual in character, and the details of nursery technique must be developed very largely to fit the conditions peculiar to each. This is particularly true of soil fertility maintenance, which is fully as important as current seedling production. It is somewhat less true of density of stand, which usually should be between 30 and 40 seedlings per square foot.

It is foolhardy to gamble on escape from known, serious insects, diseases, or pests commonly occurring in the neighborhood or appearing in the nursery, or on nonoccurrence of new pests. Prompt, correct diagnosis of any trouble and immediate action to control it are imperative.

Breakage of lateral roots during lifting is the error in nursery practice apparently most likely to reduce the initial survival of planted seedlings directly. Exposing the roots to drying for 10 minutes or more is dangerous but, with ordinary care and supervision, need not occur.

The recognition, and the production at will, of nursery stock of high physiological quality is the outstanding unsolved problem presently confronting nurserymen and nursery investigators. Granted insect- and disease-free stock with adequate lateral roots, the physiological quality of the stock appears to have more effect on initial survival than anything else under the nurseryman's control, and often far more than anything the planter does to the trees.

PLANTING

In planting, good initial survival depends primarily on : (a) Avoiding excessive root exposure (including exposure in the heel-in) ; (b) *setting the seedling at the depth at which it grew in the nursery* or a small fraction of an inch deeper ; and (c) closing the *top* of the slit or furrow tightly in bar or machine planting. All other choices, practices, decisions, or errors appear to be secondary in most cases, or to affect labor efficiency and costs rather than survival. Preparation of the site is ordinarily unnecessary except where carpetgrass, Bermudagrass, lespedeza, or gallberry necessitates furrowing to reduce competition, or heavy *Andropogon* or other rough calls for burning to expedite work or get rid of cotton rats. Mulching a circle

2 to 3 feet in diameter around each tree, with pine needles or grass, seems a promising treatment on bare, eroding sites. Puddling seedling roots is unnecessary. In bar planting, having the planter carry and set his own trees greatly increases output per man-hour.

Southern pines planted under scrub oaks or other hardwoods ordinarily must be released at the time of planting or in the first to the third or fourth growing season thereafter to avoid bad delay in height growth and, in extreme cases (particularly with longleaf) , heavy mortality. Poisoning the oaks with Ammate or some other chemical is a promising means of release, as it greatly reduces sprouting. An alternative method, applicable over great acreages, is to preempt the openings in the brush fields with closely spaced pine, leaving the denser thickets unplanted.

PLANTATION CARE

Advance control of injurious agents such as fire, hogs, sheep, pocket gophers, and leaf-cutting ants, and unremitting vigilance and prompt action to avoid or control other causes of injury, are essential to success. Additional major dangers are drought, ice, rabbits, southern fusiform rust (especially on slash pine) , and brown spot (on longleaf). Prescribed burning to control brown spot probably is necessary to insure good survival and early height growth of planted longleaf pine at reasonable cost over much of its range.

Replacements in plantations that have fallen below an acceptable level of initial survival should be made within 2 years, except in longleaf plantations, which can be replanted effectively at any time up to the general commencement of height growth.

Cultivation and fertilization of plantations are not recommended. They have not been shown to repay the considerable costs involved, and they increase rust infection, especially of slash pine, in areas of high fusiform-rust hazard.

It is essential in the first thinning of southern pine plantations to thin before stagnation sets in (usually while the live crowns of dominant and codominant trees still average 40 to 35 percent of the total heights), and to leave ample trees per acre for subsequent thinnings and the final crop. Slash pine is most likely to stagnate; longleaf very unlikely to. The first thinning usually involves removal of defective trees more than adjustment of spacing, and, if spacing is close and survival good, should take out most of the badly injured trees. If spacing has been well chosen, thinnings ordinarily need not and should not be made until the products cut will at least repay the cost of the operation.

When the trees are about 34 feet high, pruning 150 to 200 well-formed, well-spaced trees per acre to a height of 17 feet gives promise of greatly increasing the profits from plantations intended to produce saw timber or veneer bolts.

LITERATURE CITED

- (1) ANONYMOUS.
1926. CATTLE BROWSE SOUTHERN PINES. U. S. Forest Serv. Forest Worker, July 1926: 38. [Processed.]
- (2) 1928. LOBLOLLY PLANTATION IN NEW JERSEY MAKES GOOD GROWTH. U. S. Forest Serv. Forest Worker 4 (2): 15.
- (3) 1928. SOME PLANTING EXPERIMENTS IN TEXAS. U. S. Forest Serv. Forest Worker 4 (2): 3.
- (4) 1932. PURE VERSUS MIXED PLANTATIONS. Jour. Forestry 30: 95-96.
- (5) 1935. CONTROL OF EXPOSED SOIL ON ROAD BANKS. Appalachian Forest Expt. Sta. Tech. Note 12, 4 pp., illus. [Processed.]
- (6) 1936. RABBIT DAMAGE IN RELATION TO TIME OF PLANTING. South. Forest Expt. Sta. South. Forestry Notes 17, pp. 3-4. [Processed.]
- (7) 1936. TREATMENT AGAINST DAMPING OFF. U. S. Dept. Agr., Bur. Plant Industry, 12 pp. [Processed.]
- (8) 1938. DOES FREEZING INJURE PLANTING STOCK? Jour. Forestry 36: 1244-1245.
- (9) 1938. IS SPRING OR FALL THE BETTER PLANTING SEASON? Jour. Forestry 36: 1160-1161.
- (10) 1938. WATERING REDUCES SOIL-SURFACE TEMPERATURES. Jour. Forestry 36: 611-612, illus.
- (11) 1941. REGION EIGHT 1940 PLANTING REPORT EXCERPT. U. S. Forest Serv. Planting Quarterly 10 (2): 16-17. [Processed.]
- (12) 1941. YEARLY PLANTING CHARTS FOR 1940. U. S. Forest Serv. Planting Quarterly 10 (2): 23-24, 1-14, illus. [Processed.]
- (13) 1945. POSSIBILITIES FOR USING SAWDUST AS FERTILIZER. Forest Farmer 4 (12): 4.
- (14) 1945. SUGGESTIONS REGARDING THE USE OF DDT BY CIVILIANS. U. S. Dept. Agr. Agr. Research Admin., 10 pp. [Processed.]
- (15) 1946. PLANTED PINES NEED THINNING. Forest Farmer 5 (8): 1.
- (16) 1946. TWO CORDS OF WOOD PER ACRE PER YEAR. Forest Farmer 5 (6) : 6, illus.
- (17) 1947. CURRENT STATUS OF THE WHITE-FRINGED BEETLE. Amer. Nurseryman 86 (6): 43.
- (18) 1947. EUROPEAN ELM SCALE. Amer. Nurseryman 86 (5) : 54-55.
- (19) 1947. HEPT FOR RED SPIDER. Amer. Nurseryman 86 (71. 18.
- (20) ANONYMOUS.
1947. KILLING WEED TREES. Amer. Nurseryman 86 (7): 32-33.
- (21) 1947. PEACH SCALE CONTROL. Amer. Nurseryman 86 (4): 58.
- (22) 1947. SAFETY RULES FOR USE OF INSECTICIDES. Amer. Nurseryman 86 (5): 45.
- (23) 1947. SHEEP DAMAGE TO LONGLEAF PINE SEEDLINGS. South. Lumberman 175 (2201): 125.
- (24) 1947. SPIDER ON ARBORVITAE. A11101. Nurseryman 86 (4): 26.
- (25) 1947. TREE PLANTERS TO AID IN REFORESTATION. Ala. Conserv. 18: 8, 13, 14, illus.
- (26) 1948. FLORIDIANS HOLD COLORFUL CONVENTION. Amer. Nurseryman 87 (10): 7-8, 49-55, illus.
- (27) 1948. HUNTSVILLE HOST TO SOUTHERNERS. Amer. Nurseryman 88 (6): 7-8, 40-44, illus.
- (28) 1948. ILLINOIS MEETING DRAWS DISTANT VISITORS. Amer. Nurseryman 87 (3): 7, 51-57, illus.
- (29) 1948. LONG ISLAND SCHOOL. Amer. Nurseryman 87 (5): 76.
- (30) 1948. NORTHWEST FORESTERS DESIGN IMPROVED PLANT HOE. Soc. Amer. Foresters Forestry News 3 (1): 8.
- (31) 1948. PARATHION ON FRUITS. Amer. Nurseryman 88 (10): 12.
- (32) 1948. PLANTATION RELEASE BY USE OF CHEMICALS. Jour. Forestry 46: 690-691.
- (33) ABEL, G. W.
1947. SUPPRESSION OF HARDWOOD ON PINE LAND. Miss. Farm Res. 10 (2): 1, 8, illus.
- (34) 1948. SLASH PINE DAMAGED MORE BY ICE THAN OTHER SPECIES. Miss. Farm Res. 11 (9): 1, 3, illus.
- (35) ADDOMS, R. M.
1946. ENTRANCE OF WATER INTO SUBERIZED ROOTS OF TREES. Plant Physiol. 21: 109-111.
- (36) AFANASIEV, M., AND FENTON, F. A.
1947. PINE TIP MOTH AND ITS CONTROL IN OKLAHOMA. Jour. Forestry 45: 127-128.
- (37) ALEXANDER, E. D.
1939. AUSTRIAN WINTER PEAS AND THE VETCHES FOR FERTILIZER, FEED, AND SOIL PROTECTION. Univ. Ga. Agr. Ext. Serv. Bul. 453, rev., 24 pp., illus.
- (38) ALLEN, G. S.
1941. A BASIS FOR FORECASTING SEED CROPS OF SOME CONIFEROUS TREES. Jour. Forestry 39: 1014-1016, illus.
- (39) 1942. DOUGLAS FIR SEED FROM YOUNG TREES. Jour. Forestry 40: 722-723.

- (40) ALLEN, G. S.
1942. PARTHENO-CARPY, PARTHENOGENESIS, AND SELF-STERILITY OF DOUGLAS FIR. *Jour. Forestry* 40: 642-644.
- (41) _____
1947. MOLD-FREE GERMINATION OF CONIFEROUS SEEDS. *Jour. Forestry* 45: 51, illus.
- (42) ALLEN, R. C.
1942. UTILITY TRACTOR FOR CULTIVATING, FERTILIZING, AND SPRAYING FOREST TREE SEEDLINGS. *Jour. Forestry* 40: 432, illus.
- (43) ALTPETER, L. S.
1941. REFORESTATION OF SANDBLOWS IN NORTHERN VERMONT. *Jour. Forestry* 39: 705-709, illus.
- (44) ALTSCHUL, A. M., KARON, A. L., KYAME, L., AND HALL, C. M.
1946. EFFECT OF INHIBITORS ON THE RESPIRATION AND STORAGE OF COTTONSEED. *Plant Physiol.* 21: 573-587, illus.
- (45) AMERICAN ASSOCIATION OF ECONOMIC ENTOMOLOGISTS, EASTERN BRANCH.
1947. ENTOMA, A DIRECTORY OF INSECT AND PLANT PEST CONTROL. Ed. 7, 416 pp., illus.
- (46) _____
1949-50. ENTOMA, A DIRECTORY OF INSECT AND PLANT PEST CONTROL. Ed. 8, 372 pp., illus.
- (47) AMERICAN RED CROSS.
1945. FIRST AID TEXTBOOK. Rev., 254 pp., illus. Philadelphia.
- (48) ANDERSON, D. A.
1948. FOREST RESOURCES OF TEXAS. *Forest Farmer.* 7 (12): 4-5, illus.
- (49) _____ AND KINNEER, G. U.
1949. THE USE OF COPPER NAPHTHENATE TREATED BURLAP IN FOREST NURSERY OPERATIONS. *Jour. Forestry* 47: 470-473, illus.
- (50) ANDERSON, J. C., AND WOLF, D. E.
1947. PRE-EMERGENCE CONTROL OF WEEDS IN CORN WITH 2,4-D. *Amer. Soc. Agron. Jour.* 39: 341-342, illus.
- (51) ANDREWS, L. K.
1941. EFFECTS OF CERTAIN SOIL TREATMENTS ON THE DEVELOPMENT OF LOBLOLLY PINE NURSERY STOCK. *Jour. Forestry* 39: 918-921.
- (52) ANDREWS, W. B.
1947. THE RESPONSE OF CROPS AND SOILS TO FERTILIZERS AND MANURES. 459 pp., illus. State College, Miss.
- (53) ANTHONY, H. E.
1928. FIELD BOOK OF NORTH AMERICAN MAMMALS. 625 pp., illus. New York.
- (54) ASHE, H. J.
1946. TREES PLANTED FOR AIR. *Nation's Business* 34 (1): 97, illus.
- (55) ASSOCIATION OF OFFICIAL SEED ANALYSTS OF NORTH AMERICA, COMMITTEE ON QUALIFICATIONS.
1939. QUALIFICATIONS OF ANALYSTS AND NECESSARY EQUIPMENT FOR SEED ANALYTICAL WORK. *Assoc. Off. Seed Anal. No. Amer. Proc.* 30th Ann. Meeting: 80.
- (56) ATKESON, F. W., HULBERT, H. W., and WARREN, T. R.
1934. EFFECT OF BOVINE DIGESTION AND OF MANURE STORAGE ON THE VIABILITY OF WEED SEEDS. *Amer. Soc. Agron. Jour.* 26: 390-397.
- (57) ATTRIDGE, J. M., and LIMING, F. G.
1940. ESTABLISHMENT OF SHORTLEAF PINE IN THE MISSOURI OZARKS FOLLOWING SEED BED PREPARATION AND RELEASE. *Central States Forest Expt. Sta. Tech. Note* 10, 4 pp., illus.
- (58) AUTEN, J. T.
1939. A FOREST SOIL RESEARCH PROGRAM FOR THE CENTRAL STATES. *Jour. Forestry* 37: 153-156.
- (59) AUTEN, J. T.
1945. RELATIVE INFLUENCE OF SASSAFRAS, BLACK LOCUST, AND PINES UPON OLD-FIELD SOILS. *Jour. Forestry* 43: 441-446.
- (60) _____
1945. RESPONSE OF SHORTLEAF AND PITCH PINES TO SOIL AMENDMENTS AND FERTILIZERS IN NEWLY ESTABLISHED NURSERIES IN THE CENTRAL STATES. *Jour. Agr. Res.* 70: 405-426, illus.
- (61) AVERELL, J. L.
1945. RULES OF THUMB FOR THINNING LOBLOLLY PINE. *Jour. Forestry* 43: 649-651, illus.
- (62) AVERY G. S., JR., JOHNSON, E. B., ADDOMS, R. M., AND THOMSON, B. F.
1947. HORMONES AND HORTICULTURE. 326 pp., illus. New York.
- (63) BAKER, F. S.
1934. THEORY AND PRACTICE OF SILVICULTURE. 502 pp., illus. New York.
- (64) _____
1946. REPRODUCTION OF UPLAND CONIFERS IN THE LAKE STATES AS AFFECTED BY ROOT COMPETITION AND LIGHT. By Hardy L. Shirley. *Amer. Midland Nat.* 33: 537-612. (Review.) *Jour. Forestry* 44: 220-221.
- (65) BALDWIN, H. I.
1930. THE EFFECT OF AFTER-RIPENING TREATMENT ON THE GERMINATION OF EASTERN HEMLOCK SEED. *Jour. Forestry* 28: 853-857, illus.
- (66) _____
1932. COMMENT ON CUTTING TESTS FOR SEEDS. *Jour. Forestry* 30: 746-747.
- (67) _____
1934. EFFECT OF AFTER-RIPENING TREATMENT ON GERMINATION OF WHITE PINE SEEDS OF DIFFERENT AGES. *Bot. Gaz.* 96: 372-376, illus.
- (68) _____
1934. FURTHER NOTES ON THE GERMINATION OF HEMLOCK SEED. *Jour. Forestry* 32: 99-100.
- (69) _____
1936. FURTHER COMMENT ON SEED PROGRAM. *Jour. Forestry* 34: 1063-1064.
- (70) _____
1939. SOME NEW ASPECTS OF SEED CERTIFICATION. *Jour. Forestry* 37: 28-34.
- (71) _____
1942. FOREST TREE SEED OF THE NORTH TEMPERATE REGIONS WITH SPECIAL REFERENCE TO NORTH AMERICA. 240 pp., illus. Waltham, Mass.
- (72) _____ AND SHIRLEY, H. L.
1936. FOREST SEED CONTROL. *Jour. Forestry* 34: 653-663.
- (73) _____ AND TROOP, B. S.
1948. EFFECT OF SPACING ON GROWTH OF A NORWAY PINE PLANTATION. N. H. Forestry and Recreation Dept. *Fox Forest Notes* 35, 2 pp. [Processed.]
- (74) BALTHIS, R. F., AND ANDERSON, D. A.
1944. EFFECT OF CULTIVATION IN A YOUNG SLASH PINE PLANTATION ON THE DEVELOPMENT OF CRONARTIUM CANKERS AND FORKED TREES. *Jour. Forestry* 42: 926-927.
- (75) BARRETT, L. I.
1940. OBSERVATIONS ON REQUIREMENTS FOR RESTOCKING CUT OVER LOBLOLLY AND SHORTLEAF PINE STANDS. *Appalachian Forest Expt. Sta. Tech. Note* 42, 9 pp. [Processed.]
- (76) _____
1946. THE STATUS OF SILVICULTURAL RESEARCH. *Jour. Forestry* 44: 972-977.
- (77) _____ AND BUELL, J. H.
1938. GROWTH OF PRUNED WHITE PINE. *Appalachian Forest Expt. Sta. Tech. Note* 32, 2 pp. [Processed.]

- (78) BARRETT, L. I., AND DOWNS, A. A.
1943. GROWTH RESPONSE OF WHITE PINE IN THE SOUTHERN APPALACHIANS TO GREEN PRUNING. *Jour. Forestry* 41: 507-510, illus.
- (79) AND DOWNS, A. A.
1943. HARDWOOD INVASION IN PINE FORESTS OF THE PIEDMONT PLATEAU. *Jour. Agr. Res.* 67: 111-128, illus.
- (80) BARRY, J. J.
1938. DAMAGE TO 1-0 SHORTLEAF PINE DUE TO GRAZING. *U. S. Forest Serv. Planting Quart.* 7 (1): 11. [Processed.]
- (81) BARTLETT, M. S.
1947. THE USE OF TRANSFORMATIONS. *Biometrics* 3: 39-52.
- (82) BARTON, L. V.
1928. HASTENING THE GERMINATION OF SOUTHERN PINE SEEDS. *Jour. Forestry* 26: 774-785, illus.
- (83) 1930. HASTENING THE GERMINATION OF SOME CONIFEROUS SEEDS. *Amer. Jour. Bot.* 17: 88-115. (Reprinted in: Boyce Thompson Inst. Contrib. 2: 315-342, illus. 1929-30.)
- (84) 1935. STORAGE OF SOME CONIFEROUS SEEDS. *Boyce Thompson Inst. Contrib.* 7: 379-404, illus.
- (85) 1940. SOME EFFECTS OF TREATMENT OF SEEDS WITH GROWTH SUBSTANCES ON DORMANCY. *Boyce Thompson Inst. Contrib.* 11: 229-240, illus.
- (86) 1941. RELATION OF CERTAIN AIR TEMPERATURES AND HUMIDITIES TO VIABILITY OF SEEDS. *Boyce Thompson Inst. Contrib.* 12: 85-102, illus.
- (87) 1943. EFFECT OF MOISTURE FLUCTUATIONS ON THE VIABILITY OF SEEDS IN STORAGE. *Boyce Thompson Inst. Contrib.* 13: 35-45, illus.
- (88) 1947. EFFECT OF DIFFERENT STORAGE CONDITIONS ON THE GERMINATION OF SEEDS OF CINCHONA LEDGERIANA MOENS. *Boyce Thompson Inst. Contrib.* 15: 1-10.
- (89) AND GARMAN, H. R.
1946. EFFECT OF AGE AND STORAGE CONDITION OF SEEDS ON THE YIELDS OF CERTAIN PLANTS. *Boyce Thompson Inst. Contrib.* 14: 243-255, illus.
- (90) BATES, C. G.
1928. TREE "SEED FARMS". *Jour. Forestry* 26: 969-976.
- (91) 1934. THE PLAINS SHELTERBELT PROJECT. *Jour. Forestry* 32: 978-991.
- (92) AND RUDOLF, P. O.
1938. CREATING NEW FORESTS. *Jour. Forestry* 36: 844-846.
- (93) BAUMHOFER, L. G.
1936. PREVENTING THE DISTRIBUTION OF PINE TIP MOTHS ON NURSERY STOCK. *U. S. Dept. Agr. Bur. Ent. and Plant Quar. Mimeographed Cir. E-366*, 4 pp. [Processed.]
- (94) BAXTER, D. V.
1937. DEVELOPMENT AND SUCCESSION OF FOREST FUNGI AND DISEASES IN FOREST PLANTATIONS. *Mich. Univ. School Forestry and Conserv. Cir. 2*, 45 pp., illus.
- (95) 1943. PATHOLOGY IN FOREST PRACTICE. 618 pp., illus. New York.
- (96) BEAL, J. A.
1942. MORTALITY OF REPRODUCTION DEFOLIATED BY THE RED-HEADED PINE SAWFLY (NEODIPRION LECONTEI FITCH). *JOIN. Forestry* 40: 562-563.
- (97) BEAR, F. E.
1946. THE REAL VALUES OF SOIL ORGANIC MATTER. *Jour. Soil and Water Conserv.* 1: 81-84, 100.
- (98) BECTON, W. R.
1933. COST OF THINNING LONG-LEAF PINE. *Jour. Forestry* 31: 345-346.
- (99) _____
1936. EFFECTS OF VARYING DENSITIES OF HARDWOOD COVER ON GROWTH AND SURVIVAL OF SHORTLEAF PINE REPRODUCTION. *Jour. Forestry* 34: 160-164, illus.
- (100) BEHRE, C. E.
1932. SOME ASPECTS OF THE FOREST PLANTING SITUATION IN THE NORTHEAST. *Jour. Forestry* 30: 162-168.
- (101) BENEDICT, H. M., and KROFCHEK, A. W.
1946. THE EFFECT OF PETROLEUM OIL HERBICIDES ON THE GROWTH OF GUAYULE AND WEED SEEDLINGS. *Amer. Soc. Agron. Jour.* 38: 882-895, illus.
- (102) BENNETT, J. I., AND FLETCHER, P. W.
1947. LOBLOLLIES AND THE LAND. *Soil Conserv.* 13: 114-115, illus.
- (103) BERKELEY, G. H.
1944. ROOT-ROTS OF CERTAIN NON-CEREAL CROPS. *Bot. Rev.* 10: 67-123.
- (104) BICKFORD, C. A., AND BRUCE, D.
1948. FIRE AND LONGLEAF PINE REPRODUCTION. *South. Lumberman* 177 (2225): 133-135, illus.
- (105) _____ AND CURRY, J. R.
1943. THE USE OF FIRE IN THE PROTECTION OF LONGLEAF AND SLASH PINE FORESTS. *South. Forest Expt. Sta. Occas. Paper* 105, 22 pp., illus. [Processed.]
- (106) BOGGESE, W. R., AND STAHELIN, R.
1948. THE INCIDENCE OF FUSIFORM RUST IN SLASH PINE PLANTATIONS RECEIVING CULTURAL TREATMENTS. *Jour. Forestry* 46: 683-685.
- (107) BOSWELL, V. R., TOOLE, E. H., TOOLE, V. K., AND FISHER, D. F.
1940. A STUDY OF RAPID DETERIORATION OF VEGETABLE SEEDS AND METHODS FOR ITS PREVENTION. *U. S. Dept. Agr. Tech. Bul.* 708, 48 pp., illus.
- (108) BOYCE, J. S.
1937. DEVELOPMENT AND SUCCESSION OF FOREST FUNGI AND DISEASES IN FOREST PLANTATIONS. By D. V. Baxter. *Mich. Univ. School Forestry and Conserv. Cir. 2*. (Review.) *Jour. Forestry* 35: 699.
- (109) 1938. FOREST PATHOLOGY. 600 pp., illus. New York.
- (110) — — —
1948. FOREST PATHOLOGY. Ed. 2, 550 pp., illus. New York.
- (111) BRASINGTON, J. J.
1948. CATTLE GRAZING IN SOUTH ALABAMA AND WEST FLORIDA FORESTS. *South. Lumberman* 177 (2225): 183-186, illus.
- (112) _____
1948. PULL-CUT-OR POISON? *Forest Farmer* 7 (5) : 14, illus.
- (113) BRENDER, E. V., AND COOPER, I. W.
1949. TESTING MACHINE PLANTING IN CUTOVER PIEDMONT AREAS. *Forest Farmer* 9 (3): 4, 9, illus.
- (114) BRENER, W. H.
1939. MULTIPLE USE SPRAYER FOR THE APPLICATION OF LIQUID FERTILIZERS, INSECTICIDES, AND SOIL DISINFECTANTS IN FOREST NURSERIES. *Jour. Forestry* 37: 630-631, illus.

- (115) BRENER, W. H., AND WILDE, S. A.
1941. THE EFFECT OF NON-LEGUME GREEN MANURE UPON THE FERTILITY OF FOREST NURSERY SOILS. *Jour. Forestry* 39: 478-482, illus.
- (116) BRETT, C. C., AND WESTON, W. A. R. D.
1941. SEED DISINFECTION. IV. LOSS OF VITALITY DURING STORAGE OF GRAIN TREATED WITH ORGANO-MERCURY SEED DISINFECTANTS. *Agr. Sci. Jour.* 31: 500-517, illus.
- (117) BRETT, C. H., AND RHOADES, W. C.
1946. GRASSHOPPER CONTROL IN ALFALFA WITH HEXACHLOROCYCLOHEXANE DUST. *Jour. Econ. Ent.* 39: 677-678, illus.
- (118) BRIGGS, A. H.
1939. REPORT OF PLANTING EXPERIMENT TO DETERMINE THE EFFECT OF ROOT EXPOSURE ON DECIDUOUS PLANTING STOCK. *Jour. Forestry* 37: 939-943, illus.
- (119) BRINKMAN, K. A., AND SWARTHOUT, P. A.
1942. NATURAL REPRODUCTION OF PINES IN EAST-CENTRAL ALABAMA. *Ala. State Agr. Expt. Sta. Cir.* 86, 12 pp., illus.
- (120) BROWN, H. B., JOHNS, D. M., AND HADDON, C. B.
1944. DEPTH AND METHODS OF PLANTING WINTER COVER-CROP SEED IN LOUISIANA. *La. Agr. Expt. Sta. Bul.* 375, 23 pp.
- (121) BROWN, R. F.
1941. FORESTRY IN THE SOIL CONSERVATION PROGRAM IN NORTHERN MISSISSIPPI. *Jour. Forestry* 39: 598-600.
- (122) BRUCE, D.
1947. THIRTY-TWO YEARS OF ANNUAL BURNING IN LONGLEAF PINE. *Jour. Forestry* 45: 809-814, illus.
- (123) BRYAN, M. M.
1943. THE COASTAL PLAIN FOREST-FARMING PROJECT IN ATKINSON COUNTY, GEORGIA. *Jour. Forestry* 41: 20-26.
- (124) BUCHANAN, L. L.
1947. A CORRECTION AND TWO NEW RACES IN *GRA PHOGNATHUS* (WHITE-FRINGED BEETLES) (COLEOPTERA: CURCULIONIDAE). *Wash. Acad. Sci. Jour.* 37: 19-22, illus.
- (125) BUCHANAN, T. S.
1944. EFFECTS OF PRUNING YOUNG WESTERN WHITE PINE. *Jour. Forestry* 42: 365-366.
- (126) BUELL, I. H.
1940. EFFECT OF SEASON OF CUTTING ON SPROUTING OF DOGWOOD. *Jour. Forestry* 38: 649-650, illus.
- (127) ———
1943. RESULTS OF C.C.C. TIMBER STAND IMPROVEMENT ON SOUTHERN APPALACHIAN NATIONAL FORESTS. *Jour. Forestry* 41: 105-112, illus.
- (128) ———
1948. RELATION OF SOIL CHARACTERISTICS TO SITE INDEX OF LOB LOLLY AND SHORTLEAF PINES IN THE LOWER PIEDMONT REGION OF NORTH CAROLINA. By T. S. Coile. *Duke Univ. School Forestry Bul.* 13. (Review.) *Jour. Forestry* 46: 702-703.
- (129) BUHRER, E. M.
1938. ADDITIONS TO THE LIST OF PLANTS ATTACKED BY THE ROOT-KNOT NEMATODE (HETERODERA MARIONI). *U. S. Dept. Agr. Plant Dis. Reporter* 22: 216-234. [Processed.]
- (130) BULL, H.
1935. THINNING LOB LOLLY PINE IN EVEN-AGED STANDS. *Jour. Forestry* 33: 513-518.
- (131) ———
1937. TOOLS AND LABOR REQUIREMENTS FOR PRUNING LONGLEAF PINE. *Jour. Forestry* 35: 359-364.
- (132) BULL, H.
1939. INCREASED GROWTH OF LOB LOLLY PINE AS A RESULT OF CUTTING AND GIRDLING LARGE HARDWOODS. *Jour. Forestry* 37: 642-645, illus.
- (133) ———
1943. PRUNING PRACTICES IN OPEN-GROWN LONGLEAF PINE IN RELATION TO GROWTH. *Jour. Forestry* 41: 174-179, illus.
- (134) ———
1945. INCREASING THE GROWTH OF LOBLOLLY PINE BY GIRDLING LARGE HARDWOODS. *Jour. Forestry* 43: 449-450.
- (135) ———
1947. YIELDS FROM 3 SPACINGS OF PLANTED SLASH PINE. *South. Forest Expt. Sta. South. Forestry Notes* 51, p. 2. [Processed.]
- (136) ———
1949. RECOMMENDATIONS FOR THINNING YOUNG SLASH PINE. *South. Forest Expt. Sta.*, 5 pp. [Processed.]
- (137) ———
1949. RECOMMENDATIONS FOR THINNING YOUNG SLASH PINE. *Forest Farmer* 8 (6): 9.
- (138) ———
1950. POINTERS ON THINNING SOUTHERN PINE. *South. Lumberman* 181 (2273): 259-260, illus.
- (139) BURTON, G. W., AND ANDREWS, J. S.
1948. RECOVERY AND VIABILITY OF SEEDS OF CERTAIN SOUTHERN GRASSES AND LESPEDEZA PASSED THROUGH THE BOVINE DIGESTIVE TRACT. *Jour. Agr. Res.* 76: 95-103.
- (140) MCBETH, C. W., AND STEPHENS, J. L.
1946. THE GROWTH OF KOBE LESPEDEZA AS INFLUENCED BY THE ROOT-KNOT NEMATODE RESISTANCE OF THE BERMUDA GRASS STRAIN WITH WHICH IT IS ASSOCIATED. *Amer. Soc. Agron. Jour.* 38: 651-656, illus.
- (141) BYRAM, O. M.
1948. VEGETATION TEMPERATURE AND FIRE DAMAGE IN THE SOUTHERN PINES. *Fire Control Notes* 9 (4): 34-36, illus.
- (142) ——— AND LINDENMUTH, A. W., Jr.
1948. AT SOME POINTS, BACKFIRES ARE HOTTER THAN HEAD FIRES. *Jour. Forestry* 46: 782.
- (143) CAIN, S. A., AND CAIN, L. A.
1944. SIZE-FREQUENCY STUDIES OF *PINUS PALUSTRIS* POLLEN. *Ecology* 25: 229-232, illus.
- (144) ——— AND CAIN, L. A.
1944. SIZE-FREQUENCY STUDIES OF *PINUS ECHINATA* POLLEN. (Abstract.) *Ecol. Soc. Amer. Bul.* 25: 31.
- (145) CAMPBELL, R. S., AND CASSADY, J. T.
1947. BRIDGING THE GAP. *South. Lumber Jour.* 51 (3): 19-20, 87, illus.
- (146) CARDINELL, H. A., AND HAYNE, D. W.
1947. PEN TESTS OF RABBIT REPELLENTS. *Mich. Agr. Expt. Sta. Quart. Bul.* 29: 303-315.
- (147) CARTER, E. E., AND ROTHERY, J. E.
1940. UNIQUE CONDITIONS NECESSARY FOR SUCCESS? *U. S. Forest Serv. Planting Quart.* 9 (1): 16-17. [Processed.]
- (148) CASSADY, J. T., AND PEEVY, F. A.
1948. FROM SCRUBBY HARDWOODS TO MERCHANTABLE PINES. TIMBER OWNERS KILL DEFECTIVE HARDWOODS WITH CHEMICALS. *South. Lumberman* 177 (2225): 115-119, illus.
- (149) CEREMELLO, P. J.
1938. ANT CONTROL ON THE KISATCHIE NATIONAL FOREST. *U. S. Forest Serv. Planting Quart.* 7 (1): 3-4. [Processed.]
- (150) ———
1938. POCKET GOPHER CONTROL IN PLANTATIONS. *U. S. Forest Serv. Planting Quart.* 7 (3): 1. [Processed.]

- (151) CHADWICK, L. C.
1946. NURSERY FERTILIZATION. *Amer. Nurseryman* 84 (5): 28-29, 45.
- (152) _____
1946. ROOT PRUNING. *Amer. Nurseryman* 84 (3): 30.
- (153) _____
1946. SOME FERTILIZERS CHANGE SOIL REACTION. *Amer. Nurseryman* 83 (11): 20-21.
- (154) _____
1948. MIDWEST SHADE TREE CONFERENCE. *Amer. Nurseryman* 87 (6): 7-8, 54-55, illus.
- (155) CHAMPION, H. G.
1933. THE IMPORTANCE OF THE ORIGIN OF SEED USED IN FORESTRY. *Indian Forest Rec. New Ser., Silv.* 17, pt. 5 [n. p.], illus. [Reviewed by A. A. Easel in *Jour. Forestry* 32: 364-365. 1934.]
- (156) CHANDLER, R. F., Jr., SCHOEN, P. W., AND ANDERSON, D. A.
1943. RELATION BETWEEN SOIL TYPES AND THE GROWTH OF LOBLOLLY PINE AND SHORTLEAF PINE IN EAST TEXAS. *Jour. Forestry* 41: 505-506.
- (157) CHAPMAN, A. G.
1936. A BASIS FOR SELECTION OF SPECIES FOR REFORESTATION IN THE CENTRAL HARDWOOD REGION. *Central States Forest Expt. Sta. Sta. Note* 29, 6 pp. [Processed.]
- (158) _____
1937. AN ECOLOGICAL BASIS FOR REFORESTATION IN THE CENTRAL HARDWOOD REGION. *Ecology* 18: 93-105, illus.
- (159) _____
1940. PROBLEMS IN FORESTATION RESEARCH. *Jour. Forestry* 38: 176-180.
- (160) _____
1941. TOLERANCE OF SHORTLEAF PINE SEEDLINGS FOR SOME VARIATIONS IN SOLUBLE CALCIUM AND H-ION CONCENTRATION. *Plant Physiol.* 16: 313-326, illus.
- (161) _____
1944. CLASSES OF SHORTLEAF PINE NURSERY STOCK FOR PLANTING IN THE MISSOURI OZARKS. *Jour. Forestry* 42: 818-826, illus.
- (162) _____
1944. FOREST PLANTING ON STRIP-MINED COAL LANDS WITH SPECIAL REFERENCE TO onto. *Central States Forest Expt. Sta. Tech. Paper* 104, 25 pp., illus. [Processed.]
- (163) _____
1947. REHABILITATION OF AREAS STRIPPED FOR COAL. *Central States Forest Expt. Sta. Tech. Paper* 108, 14 pp. [Processed.]
- (164) _____
1948. SURVIVAL AND GROWTH OF VARIOUS GRADES OF SHORTLEAF PINE PLANTING STOCK. *Iowa State Col. Jour. Sci.* 22: 323-331.
- (165) CHAPMAN, H. H.
1926. FACTORS DETERMINING NATURAL REPRODUCTION OF LONGLEAF PINE ON CUT-OVER LANDS IN LA SALLE PARISH, LOUISIANA. *Yale Univ. School Forestry Bul.* 16, 44 pp., illus.
- (166) _____
1936. EFFECT OF FIRE IN PREPARATION OF SEED-BED FOR LONGLEAF PINE SEEDLINGS. *Jour. Forestry* 34: 852-854.
- (167) _____
1938. BIRDS AND LONGLEAF PINE REPRODUCTION. *Jour. Forestry* 36: 1246-1247.
- (168) CHAPMAN, H. H.
1939. THINNING, PRUNING AND MANAGEMENT STUDIES ON THE MAIN EXOTIC CONIFERS GROWN IN SOUTH AFRICA. By I. J. Craib. *Union So. Africa Dept. Agr. and Forestry Sci. Bul.* 196. (Review.) *Jour. Forestry* 37: 827-830.
- (169) _____
1947. RESULTS OF A PRESCRIBED FIRE AT URANIA, LA., ON LONGLEAF PINE LAND. *Jour. Forestry* 45: 121-123.
- (170) CHEO, K.
1946. ECOLOGICAL CHANGES DUE TO THINNING RED PINE. *Jour. Forestry* 44: 369-371.
- (171) CHESTER, K. S.
1942. THE NATURE AND PREVENTION OF PLANT DISEASES. 584 pp., illus. Philadelphia.
- (172) CHEYNEY, E. G.
1942. AMERICAN SILVICS AND SILVICULTURE. 472 pp., illus. Minneapolis.
- (173) CLARIDGE, F. H.
1933. OBSERVATION ON SLASH PINE IN NORTH CAROLINA. *Jour. Forestry* 31: 98-100.
- (174) CLARK, B. E.
1948. NATURE AND CAUSES OF ABNORMALITIES IN ONION SEED GERMINATION. *Cornell Univ. Agr. Expt. Sta. Mem.* 282, 27 pp., illus.
- (175) CLARK, S. F., AND WILLISTON, H. L.
1948. COST OF GIRDLING LOW-GRADE HARDWOODS. *South. Forest Expt. Sta. South. Forestry Notes* 58, pp. 3-4. [Processed.]
- (176) CLINE, A. C., AND MACALONEY, H. J.
1935. PROGRESS REPORT OF THE RECLAMATION OF SEVERELY WEEVILED WHITE PINE PLANTATIONS. *Jour. Forestry* 33: 932-935, illus.
- (177) COCKRELL, R. A.
1936. SUSCEPTIBILITY OF THE SOUTHERN PINES TO WIND DAMAGE. *Jour. Forestry* 34: 394.
- (178) COILE, T. S.
1934. INFLUENCE OF THE MOISTURE CONTENT OF SLASH PINE SEEDS ON GERMINATION. *Jour. Forestry* 32: 468-469.
- (179) _____
1935. EFFECT OF FREQUENT FIRES ON CHEMICAL COMPOSITION OF FOREST SOILS IN THE LONGLEAF PINE REGION. By Frank Heyward and R. M. Barnette. *Fla. Agr. Expt. Sta. Bul.* 265. (Review.) *Jour. Forestry* 33: 88-90.
- (180) _____
1935. RELATION OF SITE INDEX FOR SHORTLEAF PINE TO CERTAIN PHYSICAL PROPERTIES OF THE SOIL. *Jour. Forestry* 33: 726-730, illus.
- (181) _____
1937. DISTRIBUTION OF FOREST TREE ROOTS IN NORTH CAROLINA PIEDMONT SOILS. *Jour. Forestry* 35: 247-257, illus.
- (182) _____
1937. FOREST SOIL PROBLEMS IN THE PIEDMONT PLATEAU. *Jour. Forestry* 35: 344-348.
- (183) _____
1938. FOREST CLASSIFICATION: CLASSIFICATION OF FOREST SITES WITH SPECIAL REFERENCE TO GROUND VEGETATION. *Jour. Forestry* 36: 1062-1066.
- (184) _____
1948. RELATION OF SOIL CHARACTERISTICS TO SITE INDEX OF LOBLOLLY AND SHORTLEAF PINES IN THE LOWER PIEDMONT REGION OF NORTH CAROLINA. *Duke Univ. School Forestry Bul.* 13, 78 pp., illus.

- (185) COLLET, M. H.
1947. UTILIZATION OF HARDWOODS IN THE PULP AND PAPER INDUSTRY. *Jour. Forestry* 45: 445-446.
- (186) COLLINGS, G. H.
1947. COMMERCIAL FERTILIZERS, THEIR SOURCES AND USE. Ed. 4, 522 pp., illus. Philadelphia.
- (187) Cook, D. B.
1944. SODIUM ARSENITE AS A TREE-KILLER. *Jour. Forestry* 42: 141-143.
- (188) COOPER, W. E.
1942. FOREST SITE DETERMINATION BY SOIL AND EROSION CLASSIFICATION. *Jour. Forestry* 40: 709-712.
- (189) COSSITT, F. M.
1938. CULTURAL PRACTICES IN SOUTHERN FOREST NURSERIES. U. S. Dept. Agr. Forest Serv. Region 8, 21 pp., illus. [Processed.]
- (190) _____
1940. NOTES ON SEED PROCUREMENT. U. S. Forest Serv. Planting Quart. 9 (2): 8-9. [Processed.]
- (191) _____
1947. MINERAL SPIRITS AS A SELECTIVE HERBICIDE IN SOUTHERN PINE SEED-BED. *South. Lumberman* 175 (2201): 203-204, illus.
- (192) _____ AND TOMLINSON, H.
1949. PLANTING FROM THE SKIES. *South. Lumberman* 179 (2249): 176-177, illus.
- (193) COULTER, C. H.
1934. PLANTING FOREST TREES IN FLORIDA. *Fla. Forest Serv. Bul.* 8, 29 pp., illus.
- (194) _____
1946. FOREST PLANTING. *AT-FA Jour.* 8 (10) : 10-11, 17, illus.
- (195) CRAIB, I. J.
1939. THINNING, PRUNING, AND MANAGEMENT STUDIES ON THE MAIN EXOTIC CONIFERS GROWN IN SOUTH AFRICA. *Union So. Africa Dept. Agr. and Forestry Sci. Bul.* 196, 179 pp., illus.
- (196) _____
1947. THE SILVICULTURE OF EXOTIC CONIFERS IN SOUTH AFRICA. *British Empire Forestry Conf.*, 35 pp., illus. City Printing Works, Ltd., Pietermaritzburg, South Africa.
- (197) _____
1947. THE SILVICULTURE OF EXOTIC CONIFERS. *Brit. Empire Forestry Conf.*, 35 pp., illus. City Printing Works, Ltd., Pietermaritzburg, South Africa. [Reviewed by H. H. Chapman in *Jour. Forestry* 46: 390-391. 1948.]
- (198) CRAIGHEAD, F. C.
1950. INSECT ENEMIES OF EASTERN FORESTS. U. S. Dept. Agr. Misc. Pub. 657, 679 pp., illus.
- (199) _____ AND ST. GEORGE, R. A.
1928. SOME EFFECTS OF FIRE AND INSECT ATTACK ON SHORTLEAF PINE. U. S. Forest Serv. *Forest Worker.* 4 (2): 11-12.
- (200) CROCKER, W.
1948. GROWTH OF PLANTS. 459 pp., illus. New York.
- (201) CROUCH, W. E.
1933. POCKET-GOPHER CONTROL. U. S. Dept. Agr. Farmers' Bul. 1709, 21 pp., illus.
- (202) CROWELL, L.
1935. [Letter to editor.] *Jour. Forestry* 33: 705-706.
- (203) CROWL, J. M.
1939. EXPLODER SCARES BIRDS. U. S. Forest Serv. Planting Quart. 8 (4): 20. [Processed.]
- (204) GROWL, J. M.
1940. NOTE ON WHITE GRUBS AND CUTWORMS. U. S. Forest Serv. Planting Quart. 9 (1): 6. [Processed.]
- (205) CRUMB, S. E.
1926. TOBACCO CUTWORMS AND THEIR CONTROL. U. S. Dept. Agr. Farmers' Bul. 1494, 14 pp., illus.
- (206) CUMMINGS, M. B.
1946. TROUBLES OF HERBACEOUS PLANTS. *Amer. Nurseryman* 84 (8): 15, 43-45, illus.
- (207) CUMMINGS, W. H.
1941. FERTILIZER TRIALS FOR IMPROVED ESTABLISHMENT OF SHORTLEAF PINE, WHITE ASH, AND YELLOW-POPLAR PLANTINGS ON ADVERSE SITES. *Jour. Forestry* 39: 942-946.
- (208) _____
1942. EARLY EFFECTS OF PRUNING IN A YOUNG SHORTLEAF PINE PLANTING. *Jour. Forestry* 40: 61-62.
- (209) _____
1942. EXPOSURE OF ROOTS OF SHORTLEAF PINE STOCK. *Jour. Forestry* 40: 490-492, illus.
- (210) _____
1945. COPPER BASIN TEST RESULTS FOR GUIDANCE ON EROSION CONTROL PLANTING PRACTICE. *Tenn. Val. Authority*, 19 pp., illus. [Processed.]
- (211) CUNO, J. B.
1935. POWER PRUNING. *Jour. Forestry* 33: 753-754, illus.
- (212) _____
1936. AN AX FOR HACK-GIRDLING. *Jour. Forestry* 34: 813, illus.
- (213) _____
1937. CHAIN SAW FOR GIRDLING. *Jour. Forestry* 35: 503, illus.
- (214) CURRAN, C. E.
1936. PULPWOOD QUALITY OF SOUTHERN PINE AS RELATED TO THE REQUIREMENTS OF NEWS-PRINT PRODUCTION. *Jour. Forestry* 34: 198-202.
- (215) _____
1938. RELATION OF GROWTH CHARACTERISTICS OF SOUTHERN PINE TO ITS USE IN PULPING. *Jour. Forestry* 36: 576-581.
- (216) CURTIS, J. D.
1940. COMMENTS ON THE HEBBO PRUNING CLUB. *Jour. Forestry* 38: 813.
- (217) _____
1943. SOME OBSERVATIONS ON WIND DAMAGE. *Jour. Forestry* 41: 877-882, illus.
- (218) DAUBENMIRE, R. F.
1943. SOIL TEMPERATURE VERSUS DROUGHT AS A FACTOR DETERMINING LOWER ALTITUDINAL LIMITS OF TREES IN THE ROCKY MOUNTAINS. *Bot. Gaz.* 105: 1-13.
- (219) DAVIS, J. E.
1947. THE NEW LOWTHER TREE PLANTING MACHINE. *Jour. Forestry* 45: 746-748, illus.
- (220) DAVIS, K.
1935. A METHOD OF DETERMINING SPACING IN THINNING. *Jour. Forestry* 33: 80-81,
- (221) DAVIS, S. H., JR.
1942. SCLEROTIUM BATATICOLA, A CAUSE OF DAMPING-OFF IN SEEDLING CONIFERS. *Science* 95: 70.
- (222) DAVIS, W. C.
1941. DAMPING-OFF OF LONGLEAF PINE. *Phytopathology* 31: 1011-1016.
- (223) _____ WRIGHT, E., AND HARTLEY, C.
1942. DISEASES OF FOREST-TREE NURSERY STOCK. *Fed. Sec. Agency Civilian Conserv. Corps Forestry Pub.* 9, 79 pp., illus.

- (224) DAVIS, W. C., YOUNG, G. Y., LATHAM, D. H., AND HARTLEY, C.
1938. DISEASES OF CONIFERS IN FOREST NURSERIES. U. S. Dept. Agr. Bur. Plant Industry, 63 pp., illus. [Processed.]
- (225) DAVISON, V. E.
1947. WHAT TO DO ABOUT CRAYFISH. *Soil Conserv. Serv.* 13: 27-29, illus.
- (226) DEEN, J. L.
1933. EFFECT OF WEIGHT CLASS ON GERMINATION IN LONGLEAF PINE. *Jour. Forestry* 31: 434-435.
- (227) DEMMON, E. L.
1935. THE SILVICULTURAL ASPECTS OF THE FOREST-FIRE PROBLEM IN THE LONGLEAF PINE REGION. *Jour. Forestry* 33: 323-331.
- (228) DENUYL, D.
1948. FOREST PLANTATIONS, THEIR ESTABLISHMENT, GROWTH, AND MANAGEMENT. *Purdue Univ. Agr. Expt. Sta. Sta. Cir.* 331, 32 pp., illus.
- (229) DERR, H. J.
1948. KEEP LATERAL ROOTS ON LONGLEAF PLANTING STOCK. *South. Forest Expt. Sta. South. Forestry Notes* 54, pp. 3-4. [Processed.]
- (230) DILLER, J. D.
1943. A CANKER OF EASTERN PINES ASSOCIATED WITH *ATROPELLIS TINGENS*. *Jour. Forestry* 41: 41-52, illus.
- (231) DOAK, K. D., AND HARTLEY, C.
1939. THE PHYSICAL BASIS OF MYCROTROPHY IN *PINUS*. By A. B. Hatch. *Black Rock Forest Bul.* 6. (Review.) *Jour. Forestry* 37: 77-78.
- (232) DOANE, R. W., VAN DYKE, E. C., CHAMBERLIN, W. J., AND BURKE, H. E.
1936. FOREST INSECTS. 463 pp., illus. New York.
- (233) DOWNS, A. A.
1944. GROWTH OF PRUNED EASTERN WHITE PINE. *Jour. Forestry* 42: 598.
- (234) _____
1947. CHOOSING PINE SEED TREES. *Jour. Forestry* 45: 593-594.
- (235) DUCHAINE, W. J.
1949. TREE PLANTING MACHINES. *Amer. Forests* 55 (4): 23,40, illus.
- (236) DUNLAP, A. A., AND MCDONNELL, A. D.
1939. TESTING GERMINATION IN SAND. *Jour. Forestry* 37: 330-332, illus.
- (237) DUVEL, J. W. T.
1904. THE VITALITY AND GERMINATION OF SEEDS. U. S. Bur. Plant Ind. Bul. 58,96 pp., illus.
- (238) EATON, F. M., AND EGGLE, D. R.
1948. CARBOHYDRATE ACCUMULATION IN THE COTTON PLANT AT LOW MOISTURE LEVELS. *Plant Physiol.* 23: 169-187, illus.
- (239) EIDMANN, F. E.
1936. SAATGUTPRUFUNG AUF BIOCHEMISCHEN WEGE. *Ztschr. f. Forst u. Jagdw.* 68: 422-443. [Reviewed by J. F. Godfrey in *Jour. Forestry* 35: 796-797. 1937.]
- (240) ELIASON, E. J.
1935. BUCKWHEAT AS AN INDICATOR OF THE RELATIVE NITROGEN REQUIREMENT OF CONIFERS. *Jour. Forestry* 33: 628-629.
- (241) _____
1948. THE USE OF OIL SPRAYS FOR THE CONTROL OF WEEDS IN CONIFEROUS NURSERIES. N. Y. State Conserv. Dept., 8 pp. [Processed.]
- (242) _____ AND HEIT, C. E.
1940. THE RESULTS OF LABORATORY TESTS AS APPLIED TO LARGE SCALE EXTRACTION OF RED PINE SEED. *Jour. Forestry* 38: 426-429, illus.
- (243) ELIASON, E. J., AND HEIT, C. E.
1940. THE SIZE OF SCOTCH PINE CONES AS RELATED TO SEED SIZE AND YIELD. *Jour. Forestry* 38: 65-66.
- (244) ELLIOTT, F. A., AND POMEROY, K. B.
1948. ARTIFICIAL REGENERATION OF LOBLOLLY PINE ON A PRESCRIBED BURN. *Jour. Forestry* 46: 296-298.
- (245) EMERSON, A. W.
1946. SOIL CONSERVATION TREE PLANTERS READY FOR COMMERCIAL PRODUCTION. *South. Pulpwood Conserv. Assoc.*, 4 pp. illus. [Processed.]
- (246) ERAMBERT, G. F.
1940. INFESTED OZARK PLANTATIONS. U. S. Forest Serv. *Planting Quart.* 9 (2): 12. [Processed.]
- (247) ERICKSON, LAMBERT C.
1946. THE EFFECT OF ALFALFA SEED SIZE AND DEPTH OF SEEDING UPON THE SUBSEQUENT PROCUREMENT OF STAND. *Amer. Soc. Agron. Jour.* 38: 964-973, illus.
- (248) ERICKSON, LOUIS C., AND SMITH, P. F.
1947. STUDIES ON HANDLING AND TRANSPLANTING GUAYULE NURSERY STOCK. U. S. Dept. Agr. *Tech. Bul.* 924,58 pp., illus.
- (249) ERIKSSON, H. C.
1939. PLANTING TESTS. U. S. Forest Serv. *Planting Quart.* 8 (3): 1-3. [Processed.]
- (250) FENNEMAN, N. M.
1938. PHYSIOGRAPHY OF EASTERN UNITED STATES. 714 pp., illus. New York.
- (251) FISHER, P. L.
1941. GERMINATION REDUCTION AND RADICLE DECAY OF CONIFERS CAUSED BY CERTAIN FUNGI. *Jour. Agr. Res.* 62: 87-95.
- (252) FLEMING, W. E., BAKER, F. E., AND KOBLITSKY, L.
1937. EFFECT OF APPLYING ACID LEAD ARSENATE FOR CONTROL OF JAPANESE BEETLE LARVAE ON THE GERMINATION AND DEVELOPMENT OF EVERGREEN SEEDLINGS. *Jour. Forestry* 35: 679-688, illus.
- (253) FLEMION, F.
1948. RELIABILITY OF THE EXCISED EMBRYO METHOD AS A RAPID TEST FOR DETERMINING THE GERMINATIVE CAPACITY OF DORMANT SEEDS. *Boyce Thompson Inst. Contrib.* 15: 229-241.
- (254) _____ AND POOLE, H.
1948. SEED VIABILITY TESTS WITH 2, 3, 5-TRIPHENYLTETRAZOLIUM CHLORIDE. *Boyce Thompson Inst. Contrib.* 15: 243-258, illus.
- (255) FLORIDA DEPARTMENT OF AGRICULTURE.
1938. PLANT DISEASES AND PESTS AND THEIR TREATMENT. *Fla. Bul.* 3, Vol. 39, pts. I-III (rev.), 280 pp., illus.
- (256) FLORIDA FOREST AND PARK SERVICE.
1944. PROFITS FROM PLANTED SLASH PINES. *Fla., Forest and Park Serv. Cir.* 5, 3 pp., illus.
- (257) FORESTRY COMMISSION [OF GREAT BRITAIN].
1946. FORESTRY PRACTICE — A SUMMARY OF METHODS OF ESTABLISHING FOREST NURSERIES AND PLANTATIONS WITH ADVICE ON OTHER FORESTRY QUESTIONS FOR OWNERS, AGENTS, AND FORESTERS. *Forestry Comn.* 13u1. 14 (rev.), 99 pp. [Reviewed by P. O. Rudolf in *Jour. Forestry* 45: 297-298. 1947.]
- (258) FOSTER, A. C., AND TATMAN, E. C.
1940. EFFECT OF CERTAIN FUNGICIDES AND ENVIRONMENTAL FACTORS ON THE RATE OF TRANSPIRATION OF TOMATO PLANTS. *Jour. Agr. Res.* 61: 721-735, illus.

- (259) FOWELLS, H. A.
1940. CUTWORM DAMAGE TO SEEDLINGS IN CALIFORNIA PINE STANDS. *Jour. Forestry* 38: 590-591.
- (260) 1940. DISCUSSION [of PROBLEMS IN FORESTATION RESEARCH, by A. G. Chapman. *Jour. Forestry* 38: 176-180]. *Jour. Forestry* 38: 180-181.
- (261) 1943. THE EFFECT OF CERTAIN GROWTH SUBSTANCES ON ROOT-PRUNED PONDEROSA PINE SEEDLINGS. *Jour. Forestry* 41: 685-686.
- (262) AND ARNOLD, R. K.
1939. HARDWARE CLOTH SEED-SPOT SCREENS REDUCE HIGH SURFACE SOIL TEMPERATURES. *Jour. Forestry* 37: 821-822.
- (263) AND KIRK, B. M.
1945. AVAILABILITY OF SOIL MOISTURE TO PONDEROSA PINE. *Jour. Forestry* 43: 601-604.
- (264) FRANKLIN, S.
1939. MULCHING TO ESTABLISH VEGETATION ON ERODED AREAS OF THE SOUTHEAST. U. S. Dept. Agr. Leaflet 190, 8 pp., illus.
- (265) FREDERIC, J. L.
1939. A COMPARISON OF SURVIVAL AND GROWTH OF 2-0 AND 1-1 SHORTLEAF PINE. U. S. Forest Serv. Planting Quart. 8 (4): 7-8. [Processed.]
- (266) FRIEDRICH, C. A.
1947. SEEDING GRASS BY AIRPLANE ON WESTERN MONTANA'S BURNED-OVER TIMBERLANDS. Northern Rocky Mt. Forest and Range Expt. Sta. Res. Note 52, 5 pp., illus. [Processed.]
- (267) FROTHINGHAM, E. H.
1941. FORESTRY ON THE BILTMORE ESTATE. Appalachian Forest Expt. Sta. Tech. Note 43, 22 pp., illus. [Processed.]
- (268) 1942. TWENTY YEARS' RESULTS OF PLANTATION THINNING AT BILTMORE, N. C. *Jour. Forestry* 40: 444-452, illus.
- (269) GAINES, E. M.
1945. BOYS CUT WOOD ON FARM FOREST. *Forest Farmer* 4 (5): 4.
- (270) GARDNER, V. R.
1948. DOWAX AND OIL-WAX EMULSIONS TO REDUCE WATER LOSS. *Down to Earth* (Dow Chemical Co.) 4 (1): 20.
- (271) GARLOUGH, F. E., AND SPENCER, D. A.
1944. CONTROL OF DESTRUCTIVE MICE. U. S. Fish and Wildlife Serv. Conserv. Bul. 36, 37 pp., illus.
- (272) WELCH, J. F., AND SPENCER, H. J.
1942. RABBITS IN RELATION TO CROPS. U. S. Fish and Wildlife Serv. Conserv. Bul. 11, 20 pp., illus.
- (273) GAST, P. R.
1937. STUDIES ON THE DEVELOPMENT OF CONIFERS IN RAW HUMUS. III. THE GROWTH OF SCOTS PINE (*PINUS SILVESTRIS* L.) SEEDLINGS IN POT CULTURES OF DIFFERENT SOILS UNDER VARIED RADIATION INTENSITIES. *Meddel. frail Statens Skogsförsöksanstalt* 29: 587-682, illus. [Reviewed by M. A. Huberman (pp. 972-974) and J. Kittredge, Jr., (pp. 974-976) in *Jour. Forestry* 35. 1937.]
- (274) GEDDES, J. G., AND ERICKSON, A. G.
1939. THE USE OF THE TWO-HAND PRUNING SHEAR IN FOREST PRUNING. *Jour. Forestry* 37: 519-521.
- (275) GEESAMAN, D. W., AND NORRIS, T. G.
1943. DAIRY FARMING WITH SAWDUST. *Amer. Forests* 49: 164-165, illus.
- (276) GEMMER, E. W.
1928. BLACK ANTS AS DESTROYERS OF LONGLEAF PINE SEEDLINGS. *Naval Stores Rev.* 38 (7): 25.
- (277) _____
1933. CHOCTAWHATCHEE PLANTING TOOL. *Jour. Forestry* 31: 598-599, illus.
- (278) _____
1941. LOBLOLLY PINE ESTABLISHMENT AS AFFECTED BY GRAZING, OVERSTORY, AND SEEDBED PREPARATION. *Jour. Forestry* 39: 473-477.
- (279) GEORGIA DEPARTMENT OF FORESTRY.
1949. FORESTRY PROGRESS IN GEORGIA. Ga. Div. Conserv. Dept. Forestry, 1947-48 *Bien. Rept.*, 32 pp., illus.
- (280) GEORGIA DEPARTMENT OF AGRICULTURE.
1946. GEORGIA SEED LAWS AND RULES AND REGULATIONS. 24 pp., illus.
- (281) GIBBS, J. A.
1947. OBSERVATIONS OF EROSION CONTROL TREE PLANTING IN WEST TENNESSEE. U. S. Soil Conserv. Serv., 3 pp. [Processed.]
- (282) _____
1948. EROSION CONTROL TREE PLANTING. U. S. Soil Conserv. Serv. Region 2 Field Letter, *Forestry* 37, 4 pp. [Processed.]
- (283) 1948. TREE PLANTINGS CONTROL EROSION AND PRODUCE WOOD. *Forest Farmer* 8 (2): 5, illus.
- (284) GILGUT, C. J.
1948. MASSACHUSETTS NURSERYMEN MEET. *Amer. Nurseryman* 87 (4): 11, 69-71, illus.
- (285) GLEASON, C. H.
1948. HOW TO SOW MUSTARD IN BURNED WATERSHEDS OF SOUTHERN CALIFORNIA. Calif. Forest and Range Expt. Sta. Forest Res. Notes 37 (rev.), 32 pp. [Processed.]
- (286) GOODELL, B. C.
1939. SOIL FREEZING AS AFFECTED BY VEGETATION AND SLOPE ASPECT. *Jour. Forestry* 37: 626-629, illus.
- (287) GOUFFON, C. L.
1947. PLANTABLE TREES PER POUND OF SEED. *Jour. Forestry* 45: 203-204.
- (288) GOULDEN, C. H.
1939. METHODS OF STATISTICAL ANALYSIS. 277 pp., illus. New York.
- (289) GRAHAM, S. A.
1929. PRINCIPLES OF FOREST ENTOMOLOGY. 339 pp., illus. New York.
- (290) GREENE, S. W.
1935. EFFECT OF ANNUAL GRASS FIRES ON ORGANIC MATTER AND OTHER CONSTITUENTS OF VIRGIN LONGLEAF PINE SOILS. *Jour. Agr. Res.* 50: 809-822.
- (291) GROSS, L. S.
1939. 1937 PLANTING STATISTICS. U. S. Forest Serv. Planting Quart. 8 (1): appendix 1-2 and 1-12, illus.
- (292) GRUENHAGEN, R. H.
1940. GROWTH SUBSTANCES OF DOUBTFUL BENEFIT FOR TREATMENT OF PINE SEEDS. *Jour. Forestry* 38: 739-740.
- (293) GRUSCHOW, G. F.
1949. RESULTS OF A PRE-COMMERCIAL THINNING IN SLASH PINE. *South. Lumberman* 179 (2249): 230-232, illus.
- (294) GWINNER, C. C.
1946. SOAP SPREADERS. *Amer. Nurseryman* 84 (2): 86-88.

- (295) HAASIS, F. W.
1930. FOREST PLANTATIONS AT BILTMORE, NORTH CAROLINA. U. S. Dept. Agr. Misc. Pub. 61, 30 pp., illus.
- (296) HALL, R. C.
1936. CONTROL OF THE NANTUCKET PINE TIP MOTH IN THE CENTRAL STATES. U. S. Bur. Ent. and Plant Quar., E-369, 5 pp. [Processed.]
- (297) HALL, W. L.
1945. IS PINE COMING OR GOING IN SOUTH ARKANSAS? Jour. Forestry 43: 634-637.
- (298) HAMMER, C. L., AND TUKEY, L. D.
1947. SIMPLE DEVICE FOR SPRAYING. Amer. Nurseryman 86 (4) : 15, illus.
- (299) HANSBROUGH, J. R.
1936. THE TYMPANIS CANKER OF RED PINE. Yale Univ. School Forestry Bul. 43, 58 pp., illus.
- (300) HAO, K.
1939. UBER SAATGUTPRUFUNG AUF BIOCHEMISCHEN WEGE. Ztschr. f. Forst U. Jagdw. 71: 141-156, 187-204, 249-269, illus. [Reviewed by P. O. Rudolf in Jour. Forestry 38: 979. 1940.]
- (301) HARDEE, J. H.
1948. MECHANICAL TREE PLANTING IN THE SANDHILLS OF NORTH CAROLINA. Jour. Forestry 46: 608-609.
- (302) HARTLEY, C.
1935. PREVENTION OF DISEASES OF CONIFERS IN NURSERIES AND PLANTATIONS. U. S. Bur. Plant Indus., 27 pp. [Processed.]
- (303) ———
1938. A DECADE OF RESEARCH IN FOREST PATHOLOGY. Jour. Forestry 36: 908-912.
- (304) HARTMAN, E. L.
1948. SHORT COURSE AT OHIO STATE. Amer. Nurseryman 87 (5): 16, 86-90, illus.
- (305) ———
1948. OHIO SHORT COURSE. Amer. Nurseryman 87 (6) : 14, 66-80, 82, illus.
- (306) HASTINGS, W. G.
1923. REVOLUTIONIZING NURSERY PRACTICE. Jour. Forestry 21: 180-182.
- (307) HATCH, A. B.
1936. THE ROLE OF MYCORRHIZAE IN AFFORESTATION. Jour. Forestry 34: 22-29, illus.
- (308) ———
1937. THE PHYSICAL BASIS OF MYCOTROPHY IN PINUS. Black Rock Forest Bul. 6, 168 pp., illus.
- (309) ———
1940. MYCORRHIZAE AND GROWTH OF PINUS AND ARAUCARIA. THE INFLUENCE OF DIFFERENT SPECIES OF MYCORRHIZA-FORMING FUNGI ON SEEDLING GROWTH. By H. E. Young. Austral. Inst. Agr. Sci. Jour. 6: 21-25. (Review.) Jour. Forestry 38: 823-824.
- (310) HAWLEY, R. C.
1946. THE PRACTICE OF SILVICULTURE. Ed. 5, 354 pp., illus. New York.
- (311) ——— AND CLAPP, R. T.
1935. ARTIFICIAL PRUNING IN CONIFEROUS PLANTATIONS. Yale Univ. School Forestry Bul. 39, 36 pp., illus.
- (312) ——— AND CLAPP, R. T.
1935. SAW VERSUS PRUNING SHEARS. Jour. Forestry 33: 1009.
- (313) ——— AND LUTZ, H. J.
1943. ESTABLISHMENT, DEVELOPMENT, AND MANAGEMENT OF CONIFER PLANTATIONS IN THE ELI WHITNEY FOREST, NEW HAVEN, CONNECTICUT. Yale Univ. School Forestry Bul. 53, 81 pp., illus.
- (314) HAYES, R. W., AND WAKELEY, P. C.
1929. SURVIVAL AND EARLY GROWTH OF PLANTED SOUTHERN PINE IN SOUTHEASTERN LOUISIANA. La. State Univ. Bul. 21, no. 3, pt. 2, 48 pp., illus.
- (315) HEDGCOCK, G. G., AND SIGGERS, P. V.
1949. A COMPARISON OF THE PINE-OAK RUSTS. U. S. Dept. Agr. Tech. Bul. 978, 30 pp.
- (316) HEIBERG, S. O.
1933. FACTORS INFLUENCING CHOICE OF SPECIES IN ARTIFICIAL REFORESTATION. Jour. Forestry 31: 311-317.
- (317) ———
1937. MORTISING CHAINS FOR GIRDLING. Jour. Forestry 35: 790-791.
- (318) HELMERS, A. E.
1946. EFFECT OF PRUNING ON GROWTH OF WESTERN WHITE PINE. Jour. Forestry 44: 673-676, illus.
- (319) ———
1948. EARLY RESULTS FROM THINNING SEED SPOTS. North. Rocky Mt. Forest and Range Expt. Sta. Res. Note 58, 5 pp., illus. [Processed.]
- (320) HENDRICKS, B. A.
1938. REVEGETATION OF SMALL GULLIES THROUGH THE USE OF SEEDED EARTH-FILLED SACKS. Jour. Forestry 36: 348-349, illus.
- (321) HENDRICKSON, B. H.
1945. SIXTH-YEAR PROGRESS REPORT, FIELD TESTS OF FARM WOODLAND PRACTICES, TREE PLANTING STUDIES, SOUTHERN PIEDMONT EXPERIMENT STATION, WATKINSVILLE, GEORGIA. U. S. Soil Conserv. Serv., 13 pp., illus. [Processed.]
- (322) ——— AND GIBBS, J. A.
1949. TENTH-YEAR PROGRESS REPORT, FIELD TESTS OF FARM WOODLAND PRACTICES, TREE PLANTING STUDIES, SOUTHERN PIEDMONT SOIL AND WATER CONSERVATION EXPERIMENT STATION, WATKINSVILLE, GEORGIA, DECEMBER 1948. U. S. Soil Conserv. Serv. Region 2, 20 pp., illus. [Processed.]
- (323) HEFTING, G. H.
1933. EASTERN FOREST TREE DISEASES IN RELATION TO STAND IMPROVEMENT. Emergency Conserv. Work Forestry Pub. 2, 28 pp., illus.
- (324) BUCHANAN, T. S., AND JACKSON, L. W. R.
1945. LITTLE LEAF DISEASE OF PINE. U. S. Dept. Agr. Cir. 716, 15 pp., illus.
- (325) ——— AND DOWNS, A. A.
1944. ROOT AND BUTT ROT IN PLANTED WHITE PINE AT BILTMORE, NORTH CAROLINA. Jour. Forestry 42: 119-123, illus.
- (326) ——— AND ROTH, E. R.
1946. PITCH CANKER, A NEW DISEASE OF SOME SOUTHERN PINES. Jour. Forestry 44: 742-744, illus.
- (327) HEYWARD, F.
1937. THE EFFECT OF FREQUENT FIRES ON PROFILE DEVELOPMENT OF LONGLEAF PINE FOREST SOILS. Jour. Forestry 35: 23-27, illus.
- (328) ———
1938. SOIL TEMPERATURES DURING FOREST FIRES IN THE LONGLEAF PINE REGION. Jour. Forestry 36: 478-491, illus.
- (329) ——— AND BARNETTE, R. M.
1934. EFFECT OF FREQUENT FIRES ON CHEMICAL COMPOSITION OF FOREST SOILS IN THE LONGLEAF PINE REGION. Fla. Agr. Expt. Sta. Bul. 265, 39 pp.
- (330) HILL, R. E., AND HIXSON, E.
1947. HEXACHLOROCYCLOHEXANE DUSTS AND FOGS TO CONTROL GRASSHOPPERS. Jour. Econ. Ent. 40: 137-138, illus.

- (331) HOLLEY, K. T., STACY, S. V., BLEDSOE, R. P., BOGGESS, T. S., JR., AND BROWN, W. L. 1948. EFFECTS OF CROPPING SYSTEMS ON YIELDS AND THE NITROGEN AND ORGANIC CARBON IN THE SOIL. *Ga. Agr. Expt. Sta. Bul.* 257, 20 pp., illus.
- (332) HOLSOE, T. 1941. FERTILIZING PLANTING STOCK ON ERODED SOILS. *Jour. Forestry* 39: 69-70.
- (333) HOPKINS, W. 1947. HOGS OR LOGS? *South. Lumberman* 175 (2201): 151-153, illus.
- (334) ——— 1947. PERHAPS THE HOG IS HUNGRY. *South. Forest Expt. Sta. South. Forestry Notes* 50, pp. 3-4. [Processed.]
- (335) ——— 1949. MACHINE PLANTING-NO CINCH! *South. Lumberman* 179 (2249): 172-175, illus.
- (336) HORSFALL, J. G. 1945. FUNGICIDES AND THEIR ACTION. 239 pp., illus. Waltham, Mass.
- (337) ——— and HARRISON, A. L. 1939. EFFECT OF BORDEAUX MIXTURE AND ITS VARIOUS ELEMENTS ON TRANSPIRATION. *Jour. Agr. Res.* 58: 423-443, illus.
- (338) HORTON, G. S. 1936. NOVEL TOOL FOR TRANSPLANTING WILDINGS. *Jour. Forestry* 34: 180-181, illus.
- (339) Hoskins, R. N. 1947. TREE PLANTER FOR THE SOUTH. *Amer. Forests* 53: 220, 231, illus.
- (340) HOUGH, A. F. 1941. CONIFEROUS FOREST PLANTINGS IN CENTRAL PENNSYLVANIA. By Donald D. Stevenson and R. A. Bartoo. Pa. State Col. Bul. 394. (Review.) *Jour. Forestry* 39: 495-496.
- (341) HOWELL, J., JR. 1932. THE DEVELOPMENT OF SEEDLINGS OF PONDEROSA PINE IN RELATION TO SOIL TYPES. *Jour. Forestry* 30: 944-947.
- (342) HOWELL, P. N. 1948. BEGINNING OF FORESTRY PROGRAM IN MISSISSIPPI; HISTORY OF SAM BYRD MEMORIAL FOREST. *Conserv. News (Jackson, Miss.)* 3 (17): 6, illus.
- (343) HUBERMAN, M. A. 1935. MECHANICAL ADVANCES AT THE STUART FOREST NURSERY. *South. Forest Expt. Sta. Occas. Paper* 48, 8 pp., illus. [Processed.]
- (344) ——— 1940. NORMAL GROWTH AND DEVELOPMENT OF SOUTHERN PINE SEEDLINGS IN THE NURSERY. *Ecology* 21: 323-334, illus.
- (345) ——— 1940. STUDIES IN RAISING SOUTHERN PINE NURSERY SEEDLINGS. *Jour. Forestry* 38: 341-345.
- (346) HUMMEL, O. 1930. AUS DER BIOLOGIE DES SAMENTRAGENS DER WALDBAUME. *Ztschr. f. Forst u. Jagdw.* 62: 365-371. [Reviewed by J. Roeser, Jr., in *Jour. Forestry* 30: 236-239. 1932.]
- (347) HURSH, C. R. 1938. MULCHING FOR ROAD BANK FIXATION. *Appalachian Forest Expt. Sta. Tech. Note* 31, 4 pp. [Processed.]
- (348) ——— 1948. LOCAL CLIMATE IN THE COPPER BASIN OF TENNESSEE AS MODIFIED BY THE REMOVAL OF VEGETATION. U. S. Dept. Agr. Cir. 774, 38 pp., illus.
- (349) ——— and CRAFTON, W. M. 1935. PLANT INDICATORS OF SOIL CONDITIONS ON RECENTLY ABANDONED FIELDS. *Appalachian Forest Expt. Sta. Tech. Note* 17, 3 pp. [Processed.]
- (350) ILGENFRITZ, J. I. E. 1948. DEVELOPMENTS IN NURSERY MACHINERY. *Amer. Nurseryman* 87 (11): 7-9, illus.
- (351) JACKSON, L. W. R. 1945. ROOT DEFECTS AND FUNGI ASSOCIATED WITH THE LITTLE-LEAF DISEASE OF SOUTHERN PINES. *Phytopathology* 35: 91-105, illus.
- (352) JACOT, A. P. 1936. WHY STUDY THE FAUNA OF THE LITTER? *Jour. Forestry* 34: 581-583.
- (353) JESTER, J. R., AND KRAMER, P. J. 1939. THE EFFECT OF LENGTH OF DAY ON THE HEIGHT GROWTH OF CERTAIN FOREST TREE SEEDLINGS. *Jour. Forestry* 37: 796-803, illus.
- (354) JOHNSON, A. G. 1947. SOME EFFECTS OF "2,4-D" ON PINES. *Jour. Forestry* 45: 288-289.
- (355) JOHNSON, L. P. V. 1945. REDUCED VIGOUR, CHLOROPHYLL DEFICIENCY, AND OTHER EFFECTS OF SELF-FERTILIZATION IN PILAUS. *Canad. Jour. Res. Sect. C, Bot. Sci.* 23: 145-149, illus.
- (356) JOHNSON, T., AND NEWTON, M. 1946. SPECIALIZATION, HYBRIDIZATION, AND MUTATION IN THE CEREAL RUSTS. *Bot. Rev.* 12: 337-392.
- (357) JOHNSTON, H. R. 1941. TEXAS LEAF-CUTTING ANT CONTROL WITH METHYL BROMIDE. U. S. Forest Serv. *Planting Quart.* 10 (2): 18-19. [Processed.]
- (358) ——— 1944. CONTROL OF THE TEXAS LEAF-CUTTING ANT WITH METHYL BROMIDE. *Jour. Forestry* 42: 130-132, illus.
- (359) AND EATON, C. B. 1939. WHITE GRUBS IN FOREST NURSERIES OF THE CAROLINAS. U. S. Bur. Ent. and Plant Quar., E-486, 9 pp., illus. [Processed.]
- (360) AND EATON, C. B. 1942. TESTS WITH VARIOUS CHEMICALS FOR THE CONTROL OF WHITE GRUBS IN FOREST NURSERIES OF THE CAROLINAS. *JOU. Forestry* 40: 712-721.
- (361) JONES, G. W. 1948. ANNUAL PLANTING AND NURSERY REPORT, FISCAL YEAR 1948. U. S. Forest Serv. Region 9, 18 pp. [Processed.]
- (362) JORDAN, H. V., ADAMS, J. E., Hooton, D. R., PORTER, D. D. BLANK, L. M., LYLE, E. W., AND ROGERS, U. H. 1948. CULTURAL PRACTICES AS RELATED TO INCIDENCE OF COTTON ROOT ROT IN TEXAS. U. S. Dept. Agr. Tech. Bul. 948, 42 pp., illus.
- (363) JUSTICE, O. L., AND WHITEHEAD, M. D. 1946. SEED PRODUCTION, VIABILITY, AND DORMANCY IN THE NUTGRASSES *CYPERUS ROTUNDUS* AND *C. ESCULENTUS*. *Jour. Agr. Res.* 73: 303-318, illus.
- (364) KA CHIN, T. 1940. THE HEBBO PRUNING CLUB. *Jour. Forestry* 38: 596-597, illus.
- (365) KARON, M. L., AND ALTSCHUL, A. M. 1946. RESPIRATION OF COTTONSEED. *Plant Physiol.* 21: 506-521, illus.
- (366) KELLEY, O. J., HUNTER, A. S., AND HOBBS, C. H. 1945. THE EFFECT OF MOISTURE STRESS ON NURSERY-GROWN GUAYULE WITH RESPECT TO THE AMOUNT AND TYPE OF GROWTH AND GROWTH RESPONSE ON TRANSPLANTING. *Amer. Soc. Agron. Jour.* 37: 194-216, illus.
- (367) KELLOGG, L. F. 1936. AN IMPROVEMENT FOR THE EHRHART PLANTING TRAY. *Jour. Forestry* 34: 947-948, illus.

- (368) KELSHEIMER, E. G.
1947. DDT TREATMENTS FOR CONTROL OF MOLE-CRICKETS IN SEEDBEDS. Fla. Agr. Expt. Sta. Bul. 434, 19 pp., illus.
- (369) 1948. PARATHION (3422), A NEW AND POTENT INSECTICIDE. Fla. Agr. Expt. Sta. Press Bul. 641, 3 pp.
- (370) KEYES, J., AND SMITH, C. F.
1943. PINE SEED-SPOT PROTECTION WITH SCREENS IN CALIFORNIA. Jour. Forestry 41: 259-264, illus.
- (371) KIENHOLZ, R.
1941. JACK PINE IN CONNECTICUT DAMAGED BY SLEET STORM. Jour. Forestry 39: 874-875, illus.
- (372) KIENITZ, M.
1931. UEBER DE BEDEUTUNG DER NATURWISSENSCHAFTLICHEN GRUNDLAGEN DER DURCHFORSTUNGLEHRE. Ztschr. f. Forst u. Jagdw. 63: 32 pp., illus. (Reviewed by J. Roesser, Jr., in Jour. Forestry 30: 893-895. 1932.)
- (373) KLINGMAN, G. C.
1948. SOUTHERN WEED CONFERENCE, DELTA BRANCH EXPERIMENT STATION, JUNE 10, 1948. [Proceedings of the Delta Council, Stoneville, Miss.] 46 pp. [Processed.]
- (374) KNAPP, G. E.
1945. THE WISCONSIN TREE PLANTING MACHINE. South. Pulpwood Conserv. Assoc., 1 p. [Processed.]
- (375) 1946. GAIR WOODLANDS PLANTING OPERATION TESTING SYRACUSE FORESTRY PLOW. South. Pulpwood Conserv. Assoc., 2 pp., illus. [Processed.]
- (376) 1946. VALDOSTA TREE PLANTER. South. Pulpwood Conserv. Assoc., 2 pp., illus. [Processed.]
- (377) KOEHLER, A.
1936. A METHOD OF STUDYING KNOT FORMATION. Jour. Forestry 34: 1062-1063, illus.
- (378) 1938. RAPID GROWTH HAZARDS USEFULNESS OF SOUTHERN PINE. Jour. Forestry 36: 153-158, illus.
- (379) 1938. WOOD QUALITY—A REFLECTION OF GROWTH ENVIRONMENT. Jour. Forestry 36: 867-869.
- (380) KOPITKE, J. C.
1941. THE EFFECT OF POTASH SALTS UPON THE HARDENING OF CONIFEROUS SEEDLINGS. Jour. Forestry 39: 555-558, illus.
- (381) KORSTIAN, C. F., AND BAKER, F. S.
1925. FOREST PLANTING IN THE INTERMOUNTAIN REGION. U. S. Dept. Agr. Dept. Bul. 1264, 57 pp., illus.
- (382) AND COILE, T. S.
1938. PLANT COMPETITION IN FOREST STANDS. Duke Univ. School Forestry Bul. 3, 125 pp., illus.
- (383) KOWAL, J.
1948. PINE SAWFLY IN SOUTHERN ARKANSAS. Forest Farmer 8 (2): 3, 10, illus.
- (384) KOZLOWSKI, T. T., AND SCHOLTES, W. H.
1948. GROWTH OF ROOTS AND ROOT HAIRS OF PINE AND HARDWOOD SEEDLINGS IN THE PIEDMONT. Jour. Forestry 46: 750-754.
- (385) KRAMER, J., AND WEAVER, J. E.
1936. RELATIVE EFFICIENCY OF ROOTS AND TOPS OF PLANTS IN PROTECTING THE SOIL FROM EROSION. Nebraska Univ., Conserv. and Soil Survey Bul. 12, 94 pp.
- (386) KRAMER, P. J.
1946. ABSORPTION OF WATER THROUGH SUBERIZED ROOTS OF TREES. Plant Physiol. 21: 37-41, illus.
- (387) AND CLARK, W. S.
1947. A COMPARISON OF PHOTOSYNTHESIS IN INDIVIDUAL PINE NEEDLES AND ENTIRE SEEDLINGS AT VARIOUS LIGHT INTENSITIES. Plant Physiol. 22: 51-57, illus.
- (388) AND COILE, T. S.
1940. AN ESTIMATION OF THE VOLUME OF WATER MADE AVAILABLE BY ROOT EXTENSION. Plant Physiol. 15: 743-747.
- (389) AND DECKER, J. P.
1944. RELATION BETWEEN LIGHT INTENSITY AND RATE OF PHOTOSYNTHESIS OF LOBLOLLY PINE AND CERTAIN HARDWOODS. Plant Physiol. 19: 350-358, illus.
- (390) KRAUCH, H.
1938. USE OF PROTECTIVE SCREENS IN SEED-SPOT SOWING FOUND TO SERVE TWO-FOLD PURPOSE. Jour. Forestry 36: 1240.
- (391) KROODSMA, R. F.
1939. COMMENTS ON "WHY FOREST PLANTATIONS FAIL." Jour. Forestry 37: 822-823.
- (392) KYD, S.
[n. d.] NEW INSECTICIDES FOR GRASSHOPPER CONTROL. Okla. Agr. Col. Ext. Cir. 483, 3 pp.
- (393) LACHMAN, W. H.
1945. CONTROL OF WEEDS IN CARROT AND PARSNIP FIELDS WITH OIL SPRAY. Mass. Agr. Col. Ext. Spec. Cir. 120, 8 pp.
- (394) LAMB, H., AND SLEETH, B.
1940. DISTRIBUTION AND SUGGESTED CONTROL MEASURES FOR THE SOUTHERN PINE FUSIFORM RUST. South. Forest Expt. Sta. Occas. Paper 91, 5 pp., illus. [Processed.]
- (395) LANE, R. D., AND FASSNACHT, D. L.
1948. YOUNG PINE PLANTATION THINNINGS YIELD MERCHANTABLE PRODUCTS. Central States Forest Expt. Sta. Sta. Notes 51, 2 pp. [Processed.]
- (396) AND LIMING, F. G.
1939. SOME EFFECTS OF RELEASE ON PLANTED SHORTLEAF PINE IN THE MISSOURI OZARKS. Central States Forest Expt. Sta. Sta. Note 37, 6 pp., illus. [Processed.]
- (397) AND McComa, A. L.
1948. WILTING AND SOIL MOISTURE DEPLETION BY TREE SEEDLINGS AND GRASS. Jour. Forestry 46: 344-349, illus.
- (398) LANQUIST, K. B.
1946. TESTS OF SEVEN PRINCIPAL FOREST TREE SEEDS IN NORTHERN CALIFORNIA. Jour. Forestry 44: 1063-1066.
- (399) LATHAM, D. H., AND DAVIS, W. C.
1939. SOME RECENT DISEASE DEVELOPMENTS IN FOREST TREE NURSERIES. Phytopathology 29: 14.
- (400) DOAK, K. D., AND WRIGHT, E.
1939. MYCORRHIZAE AND PSEUDOMYCORRHIZAE ON PINES. Phytopathology 29: 14.
- (401) LAWRENCE, D. B., LAWRENCE, E. G., AND SEIM, A. L.
1947. DATA ESSENTIAL TO COMPLETENESS OF REPORTS ON SEED GERMINATION OF NATIVE PLANTS. Ecology 28: 76-78.
- (402) LAY, D. W., AND TAYLOR, W. P.
1943. WILDLIFE ASPECTS OF CUTOVER PINE WOODLAND IN EASTERN TEXAS. Jour. Forestry 41: 446-448, illus.
- (403) LEACH, L. D.
1947. GROWTH RATES OF HOST AND PATHOGEN AS FACTORS DETERMINING THE SEVERITY OF PREEMERGENCE DAMPING-OFF. Jour. Agr. Res. 75: 161-179, illus.

- (404) LEAR, W. L.
1935. FOREST PLANTING IN ARKANSAS. Ark. State Forestry Comn. Bul. 6, 12 pp., illus.
- (405) LEBARRON, R. K., FOX, G., AND BLYTHE, R. H., JR.
1938. THE EFFECT OF SEASON OF PLANTING AND OTHER FACTORS ON EARLY SURVIVAL OF FOREST PLANTATIONS. Jour. Forestry 36: 1211-1215.
- (406) LEIBY, R. W., AND WARD, W.
1948. A POWERFUL NEW INSECTICIDE. Country Gent. 118 (1): 20, illus.
- (407) LEMON, P. C.
1946. PRESCRIBED BURNING IN RELATION TO GRAZING IN THE LONGLEAF-SLASH PINE TYPE. Jour. Forestry 44: 115-117.
- (408) LENHART, D. Y.
1934. INITIAL ROOT DEVELOPMENT OF LONGLEAF PINE. Jour. Forestry 32: 459-461.
- (409) LENTZ, A. N.
1948. A GUIDE TO FOREST TREE PLANTING IN NEW JERSEY. N. J. State Univ. Ext. Serv. Leaf. 19, 4 pp.
- (410) _____
1948. PRUNING PINE PLANTATIONS. N. J. State Univ. Ext. Serv. Leaf. 16, 4 pp.
- (411) LENTZ, G. H.
1939. KNOTS IN SECOND-GROWTH PINE AND THE DESIRABILITY OF PRUNING. By B. H. Paul. U. S. Dept. Agr. Misc. Pub. 307. (Review.) Jour. Forestry 37: 75.
- (412) LEUREL, R. W.
1948. RECENT DEVELOPMENTS IN SEED TREATMENT. Bot. Rev. 14: 235-269.
- (413) LEWIS, E. F., AND ELIASON, E. J.
1937. THE IMPROVED SARA TØGA TREE LIFTING MACHINE. Jour. Forestry 35: 877-878, illus.
- (414) LIGON, L. L.
1945. MUN (MEANS, A LEGUME FOR SEED AND FORAGE PRODUCTION. Okla. Agr. Expt. Sta. Bul. 284, 12 pp.
- (415) LIGON, W. S.
1940. INFLUENCE OF SOIL TYPE AND OTHER SITE FACTORS ON THE SUCCESS OF TREE PLANTINGS FOR EROSION CONTROL. Jour. Forestry 38: 226-227.
- (416) LIMING, F. G.
1941. TWO NEW GIRDLING SAWS. Jour. Forestry 39: 1029-1032, illus.
- (417) _____
1945. NATURAL REGENERATION OF SHORTLEAF PINE IN THE MISSOURI OZARKS. Jour. Forestry 43: 339-345, illus.
- (418) _____
1946. RESPONSE OF PLANTED SHORTLEAF PINE TO OVERHEAD RELEASE. Central States Forest Expt. Sta. Tech. Paper 105, 20 pp., illus. [Processed.]
- (419) _____
1946. THE RANGE AND DISTRIBUTION OF SHORTLEAF PINE IN MISSOURI. Central States Forest Expt. Sta. Tech. Paper 106, 4 pp., illus. [Processed.]
- (420) _____ AND SEIZERT, B. F.
1943. RELATIVE HEIGHT GROWTH OF PLANTED SHORTLEAF PINE AND CUT-BACK AND UN-CUT HARDWOOD REPRODUCTION AFTER RELEASE. Jour. Forestry 41: 214-216.
- (421) LIMSTROM, G. A.
1948. EXTENT, CHARACTER, AND FORESTATION POSSIBILITIES OF LAND STRIPPED FOR COAL IN THE CENTRAL STATES. Central States Forest Expt. Sta. Tech. Paper 109, 79 pp., illus. [Processed.]
- (422) LINCOLN, C., AND ISELY, D.
1945. ARMY WORMS AND CUTWORMS. Ark. Agr. Col. Ext. Cir. 436, 10 pp., illus.
- (423) LINDENMUTH, A. W., JR., AND BYRAM, G. M.
1948. HEADFIRES ARE COOLER NEAR THE GROUND THAN BACKFIRES. Fire Control Notes 9 (4): 8-9, illus.
- (424) LINDGREN, R. M.
1948. CARE NEEDED IN THINNING PINES WITH HEAVY FUSIFORM RUST INFECTION. Forest Farmer 7 (12): 3, illus.
- (425) _____
1948. THINNING PINES CANKERED BY FUSIFORM RUST. South. Forest Expt. Sta. South. Forestry Notes 55, pp. 1-2. [Processed.]
- (426) _____ AND HENRY, B. W.
1949. PROMISING TREATMENTS FOR CONTROLLING ROOT DISEASE AND WEEDS IN A SOUTHERN PINE NURSERY. U. S. Dept. Agr. Plant Dis. Reporter 33: 228-231. [Processed.]
- (427) LINDQUIST, B.
1948. GENETICS IN SWEDISH FORESTRY PRACTICE. 173 pp., illus. Waltham, Mass.
- (428) LIST, G. M., AND HOERNER, J. L.
1947. DUSTS AND SPRAYS FOR GRASSHOPPER CONTROL. Jour. Econ. Ent. 40: 138.
- (429) LITTLE, S., JR.
1938. RELATIONSHIPS BETWEEN VIGOR OF RESPROUTING AND INTENSITY OF CUTTING IN COPPICE STANDS. Jour. Forestry 36: 1216-1223.
- (430) _____ ALLEN, J. P., AND MOORE, E. B.
1948. CONTROLLED BURNING AS A DUAL-PURPOSE TOOL OF FOREST MANAGEMENT IN NEW JERSEY'S PINE REGION. Jour. Forestry 46: 810-819, illus.
- (431) LITTLEFIELD, E. W.
1939. SOME NEW ASPECTS OF SEED CERTIFICATION. [By H. I. Baldwin. Jour. Forestry 37: 28-34.] (Comments.) Jour. Forestry 37: 35.
- (432) _____
1944. ESTABLISHMENT, DEVELOPMENT, AND MANAGEMENT OF CONIFER PLANTATIONS IN THE ELI WHITNEY FOREST, NEW HAVEN, CONNECTICUT. By Ralph C. Hawley and Harold J. Lutz. Yale Univ. School Forestry Bul. 53. (Review.) Jour. Forestry 42: 220-221.
- (433) LODEWICK, E.
1930. EFFECT OF CERTAIN CLIMATIC FACTORS ON THE DIAMETER GROWTH OF LONGLEAF PINE IN WESTERN FLORIDA. JOUR. Agr. Res. 41: 349-363, illus.
- (434) LUNT, H. A.
1945. MOISTURE RETENTION OF PACKING MATERIALS. Amer. Nurseryman 82 (10): 5-6, illus.
- (435) LUTHER, T. F., AND COOK, D. B.
1948. COMMERCIAL THINNING IN RED PINE PLANTATIONS. Jour. Forestry 46: 110-114, illus.
- (436) LUTZ, H. J.
1939. PLANT COMPETITION IN FOREST STANDS. By Clarence F. Korstian and Theodore S. Coile. Duke Univ. School Forestry Bul. 3. (Review.) Jour. Forestry 37: 662-663.
- (437) _____ AND CHANDLER, R. F., JR.
1946. FOREST SOILS. 514 pp., illus. New York.
- (438) LYNCH, D. W., DAVIS, W. C., ROOF, L. H., AND KORSTIAN, C. F.
1943. INFLUENCE OF NURSERY FUNGICIDE-FERTILIZER TREATMENTS ON SURVIVAL AND GROWTH IN A SOUTHERN PINE PLANTATION. Jour. Forestry 41: 411-413.
- (439) MCCALL, M. A.
1939. FOREST SEED POLICY OF U. S. DEPARTMENT OF AGRICULTURE. JOUR. Forestry 37: 820-821.

- (440) MCCALLAN, S. E. A.
1948. WHAT EVERY DEALER SHOULD KNOW ABOUT FUNGICIDES. Boyce Thompson Inst. Prof. Paper 2 (5): 35-43.
- (441) MCCOMA, A. L.
1938. THE RELATION BETWEEN MYCORRHIZAE AND THE DEVELOPMENT AND NUTRIENT ABSORPTION OF PINE SEEDLINGS IN A PRAIRIE NURSERY. Jour. Forestry 36: 1148-1151, illus.
- (442) _____ and GRIFFITH, J. E.
1946. GROWTH STIMULATION AND PHOSPHORUS ABSORPTION OF MYCORRHIZAL AND NON-MYCORRHIZAL NORTHERN WHITE PINE AND DOUGLAS FIR SEEDLINGS IN RELATION TO FERTILIZER TREATMENT. Plant Physiol. 21: 11-17, illus.
- (443) _____ and STEAVENSON, H. A.
1936. SOME NEW NURSERY EQUIPMENT. Jour. Forestry 34: 698-701, illus.
- (444) MCCOOL, M. M.
1948. STUDIES ON pH VALUES OF SAWDUSTS AND SOIL-SAWDUST MIXTURES. Boyce Thompson Inst. Contrib. 15: 279-282.
- (445) MCCORMACK, J. F.
1949. FOREST RESOURCES OF CENTRAL FLORIDA, 1949. Southeast. Forest Expt. Sta. Forest Survey Release 31, 36 pp., illus. [Processed.]
- (446) _____
1949. FOREST RESOURCES OF NORTHEAST FLORIDA, 1949. Southeast. Forest Expt. Sta. Forest Survey Release 30, 36 pp., illus. [Processed.]
- (447) _____
1950. FOREST RESOURCES OF NORTHWEST FLORIDA, 1949. Southeast. Forest Expt. Sta. Forest Survey Release 32, 36 pp., illus. [Processed.]
- (448) _____
1950. FOREST RESOURCES OF SOUTH FLORIDA, 1949. Southeast. Forest Expt. Sta. Forest Survey Release 33, 21 pp., illus. [Processed.]
- (449) MCCORMICK, L. E.
1948. PLANTING AND CARE OF FOREST TREES. Mo. Agr. Ext. Serv. Cir. 563, 12 pp., illus.
- (450) MCCULLEY, R. D.
1945. GERMINATION OF LONGLEAF PINE SEED AT HIGH AND LOW TEMPERATURES. Jour. Forestry 43: 451-452.
- (451) MCINTYRE, A. C.
1948. A REPORT ON "THE D/X SPACING RULE". Jour. Forestry 46: 526-528, illus.
- (452) _____
1948. WHY WASTE WOOD? Soil Conserv. 14: 75-78, illus.
- (453) MCKEE, R.
1947. SUMMER CROPS FOR GREEN MANURE AND SOIL IMPROVEMENT. U. S. Dept. Agr. Farmers' Bul. 1750 (rev.), 16 pp., illus.
- (454) _____ AND MCNAIR, A. D.
1948. WINTER LEGUMES FOR GREEN MANURE IN THE COTTON BELT. U. S. Dept. Agr. Farmers' Bul. 1663 (rev.), 22 pp., illus.
- (455) MCKEITHEN, T. B.
1937. AN IMPLEMENT FOR PREPARING SEEDBEDS. Jour. Forestry 35: 595-597, illus.
- (456) MCKELLAR, A. D.
1935. THE EFFECTS OF ELEVEN INCHES OF RAIN ON THE STUART FOREST NURSERY. Jour. Forestry 33: 822-823.
- (457) _____
1936. THE WEED PROBLEM AT THE STUART FOREST NURSERY, POLLOCK, LA. South. Forest Expt. Sta. Occas. Paper 55, 20 pp., illus. [Processed.]
- (458) MCKELLAR, A. D.
1942. ICE DAMAGE TO SLASH PINE, LONGLEAF PINE, AND LOBLOLLY PINE PLANTATIONS IN THE PIEDMONT SECTION OF GEORGIA. Jour. Forestry 40: 794-797, illus.
- (459) MACKINNEY, A. L., AND KORSTIAN, C. F.
1932. FELLING, GIRDLING, AND POISONING UNDESIRABLE TREES IN FOREST STANDS. Jour. Forestry 30: 169-177, illus.
- (460) _____
1938. LOBLOLLY PINE SEED DISPERSAL. Jour. Forestry 36: 465-468, illus.
- (461) _____ AND MCQUILKIN, W. E.
1938. METHODS OF STRATIFICATION FOR LOBLOLLY PINE SEEDS. Jour. Forestry 36: 1123-1127.
- (462) MCLINTOCK, T. F.
1940. EFFECT OF INTENSITY OF PRUNING ON SPROUT FORMATION IN YOUNG PLANTED PITCH PINE. Central States Forest Expt. Sta. Tech. Note 21, 3 pp. [Processed.]
- (463) _____
1940. EFFECTS OF GROUND PREPARATION ON SURVIVAL AND GROWTH OF PLANTED PINE AND BLACK LOCUST. Central States Forest Expt. Sta. Tech. Note 23, 4 pp. [Processed.]
- (464) _____
1940. GROWTH RESPONSE OF PLANTED PITCH PINE TO DIFFERENTIAL PRUNING. Central States Forest Expt. Sta. Tech. Note 15, 2 pp. [Processed.]
- (465) _____
1942. STRATIFICATION AS A MEANS OF IMPROVING RESULTS OF DIRECT SEEDING OF PINES. Jour. Forestry 40: 724-728.
- (466) MCPHERSON, J. E.
1940. GOPHER CONTROL ON THE SABINE. U. S. Forest Serv. Planting Quart. 9 (2): 14-15. [Processed.]
- (467) _____
1940. PLANTATION RELEASE-TEXAS. U. S. Forest Serv. Planting Quart. 9 (2): 2-4. [Processed.]
- (468) MCQUILKIN, W. E.
1935. ROOT DEVELOPMENT OF PITCH PINE, WITH SOME COMPARATIVE OBSERVATIONS ON SHORTLEAF PINE. Jour. Agr. Res. 51: 983-1016, illus.
- (469) _____
1940. THE NATURAL ESTABLISHMENT OF PINE IN ABANDONED FIELDS IN THE PIEDMONT PLATEAU REGION. Ecology 21: 135-147, illus.
- (470) _____
1946. TESTS OF DIRECT SEEDING WITH PINES IN THE PIEDMONT REGION. Jour. Agr. Res. 73: 113-136, illus.
- (471) _____
1946. USE OF MULCH, FERTILIZER, AND LARGE STOCK IN PLANTING CLAY SITES. Jour. Forestry 44: 28-29.
- (472) MAISSUROW, D. K.
1939. MIXED GROUP PLANTING ON THE NICOLET NATIONAL FOREST. Jour. Forestry 37: 853-855.
- (473) MAKI, T. E.
1940. SIGNIFICANCE AND APPLICABILITY OF SEED MATURITY INDICES FOR PONDEROSA PINE. Jour. Forestry 38: 55-60, illus.
- (474) _____ AND MARSHALL, H.
1945. EFFECTS OF SOAKING WITH INDOLEBUTYRIC ACID ON ROOT DEVELOPMENT AND SURVIVAL OF TREE SEEDLINGS. Bot. Gaz. 107: 268-276, illus.

- (475) MALSBERGER, H. J.
1948. REPORT ON THE LITTLELEAF PROBLEM. South. Pulpwood Conserv. Assoc., 12 pp., illus. [Processed.]
- (476) MANN, W. F., JR.
1947. SHEEP DAMAGE TO LONGLEAF PINE SEEDLINGS. South. Forest Expt. Sta. South. Forestry Notes 52, p. 1. [Processed.]
- (477) AND SCARBROUGH, N. M.
1948. CLOSE SPACING REDUCES FUSIFORM RUST. South. Forest Expt. Sta. South. Forestry Notes 53, p. 2. [Processed.]
- (478) MAR: MOLLER, C.
1947. THE EFFECT OF THINNING, AGE, AND SITE ON FOLIAGE, INCREMENT, AND LOSS OF DRY MATTER. Jour. Forestry 45: 393-404.
- (479) MARSHALL, H., AND MAKI, T. E.
1946. TRANSPIRATION OF PINE SEEDLINGS AS INFLUENCED BY FOLIAGE COATINGS. Plant Physiol. 21: 95-101, illus.
- (480) MARSHALL, R.
1931. AN EXPERIMENTAL STUDY OF THE WATER RELATIONS OF SEEDLING CONIFERS WITH SPECIAL REFERENCE TO WILTING. Ecol. Monog. 1: 37-98, illus.
- (481) MATHEWS, A. C.
1932. THE SEED DEVELOPMENT IN PINUS PALUSTRIS. Elisha Mitchell Sci. Soc. Jour. 48: 101-118, illus.
- (482) MATTOON, W. R.
1915. LIFE HISTORY OF SHORTLEAF PINE. U. S. Dept. Agr. Bul. 244, 46 pp., illus.
- (483) ———
1936. TWENTY YEARS OF SLASH PINE. Jour. Forestry 34: 562-570, illus.
- (484) ———
1942. PRUNING SOUTHERN PINES. U. S. Dept. Agr. Farmers' Bul. 1892, 34 pp., illus.
- (485) MAY, J. T.
1939. EFFECTS OF STRATIFICATION ON THE GERMINATION OF LOBLOLLY PINE SEED. U. S. Forest Serv. Planting Quart. 8 (2): 2-3. [Processed.]
- (486) MAYTON, E. L., SMITH, E. V., AND KING, D.
1945. NUTGRASS ERADICATION STUDIES: IV. USE OF CHICKENS AND GEESE IN THE CONTROL OF NUTGRASS, CYPERUS ROTUNDUS L. Amer. Soc. Agron. Jour. 37: 785-791.
- (487) MEAHL, R. P.
1948. PENNSYLVANIA NURSERYMEN'S CONFERENCE. Amer. Nurseryman 87 (6) : 9, 53-54.
- (488) MEGINNIS, H. G.
1933. TREE PLANTING TO RECLAIM GULLIED LANDS IN THE SOUTH. Jour. Forestry 31: 649-656, illus.
- (489) ———
1933. USING SOIL-BINDING PLANTS TO RECLAIM GULLIES IN THE SOUTH. U. S. Dept. Agr. Farmers' Bul. 1697, 18 pp., illus.
- (490) ———
1935. EFFECT OF COVER ON SURFACE RUN-OFF AND EROSION IN THE LOESSIAL UPLANDS OF MISSISSIPPI. U. S. Dept. Agr. Cir. 347, 16 pp., illus.
- (491) ———
1938. THE POLE-FRAME BRUSH DAM-A LOW-COST MECHANICAL AID IN REFORESTING GULLIED LAND. South. Forest Expt. Sta. Occas. Paper 76, 8 pp., illus. [Processed.]
- (492) ———
1939. SOIL-COLLECTING TRENCHES AS SUBSTITUTES FOR TEMPORARY CHECK DAMS IN REFORESTING GULLIES. Jour. Forestry 37: 764-769, illus.
- (493) MEHRING, A. L.
1945. FERTILIZER NITROGEN CONSUMPTION. Indus. and Engin. Chem. 37: 289-295, illus.
- (494) METCALF, C. L., AND FLINT, W. P.
1939. DESTRUCTIVE AND USEFUL INSECTS. Ed. 2, 981 pp., illus. New York.
- (495) MEYER, B. S.
1928. SEASONAL VARIATIONS IN THE PHYSICAL AND CHEMICAL PROPERTIES OF THE LEAVES OF THE PITCH PINE, WITH ESPECIAL REFERENCE TO COLD RESISTANCE. Amer. Jour. Bot. 15: 449-472, illus.
- (496) MEYER, W. H.
1940. PRUNING NATURAL PINE STANDS. Jour. Forestry 38: 413-414.
- (497) MIDDLETON, W.
1927. A SAWFLY INJURIOUS TO YOUNG PINES. U. S. Dept. Agr. Farmers' Bul. 1259 (rev.), 6 pp., illus.
- (498) MILLER, C. I.
1940. AN ECONOMICAL SEED SPOT PROTECTOR. Jour. Forestry 38: 733-734, illus.
- (499) MILLER, E. C.
1938. PLANT PHYSIOLOGY. 1201 pp., illus. New York.
- (500) MILLER, F. J.
1938. THE INFLUENCE OF MYCORRHIZAE ON THE GROWTH OF SHORTLEAF PINE SEEDLINGS. Jour. Forestry 36: 526-527.
- (501) MILLER, H. W., AND LEMMON, P. E.
1943. PROCESSING CONES OF PONDEROSA PINE TO EXTRACT, DEWING, AND CLEAN THE SEED. Jour. Forestry 41: 889-894, illus.
- (502) MILLER, M. F.
1947. STUDIES IN SOIL NITROGEN AND ORGANIC MATTER MAINTENANCE. MO. Agr. Expt. Sta. Res. Bul. 409, 32 pp., illus.
- (503) MINCKLER, L. S.
1939. GENETICS IN FORESTRY. Jour. Forestry 37: 559-564.
- (504) ———
1939. THE BLOCK-LINE METHOD OF PLANTATION EXAMINATION. Jour. Forestry 37: 872-875, illus.
- (505) ———
1941. PLANTATION SURVIVAL AS RELATED TO SOIL TYPE, ASPECT, AND GROWING SEASON. Jour. Forestry 39: 26-29.
- (506) ———
1941. THE RIGHT TREE IN THE RIGHT PLACE. Jour. Forestry 39: 685-688.
- (507) ———
1942. ONE-PARENT HEREDITY TESTS WITH LOBLOLLY PINE. Jour. Forestry 40: 505-506.
- (508) ———
1943. EFFECT OF RAINFALL AND SITE FACTORS ON THE GROWTH AND SURVIVAL OF YOUNG FOREST PLANTATIONS. Jour. Forestry 41: 829-833.
- (509) ———
1944. EARLY RESULTS FROM A REFORESTATION "PILOT PLANT." Jour. Forestry 42: 586-590, illus.
- (510) ———
1946. A GUIDE FOR TREE PLANTING IN THE SOUTHWEST VIRGINIA COUNTIES IN THE TENNESSEE VALLEY. Appalachian Forest Expt. Sta. Tech. Note 61, 7 pp. [Processed.]
- (511) ———
1946. OLD FIELD REFORESTATION IN THE GREAT APPALACHIAN VALLEY AS RELATED TO SOME ECOLOGICAL FACTORS. ECOL. Monog. 16: 87-108, illus.

- (512) MINCKLER, L. S.
1948. PLANTED PINES ON CLAYPAN SOILS OF SOUTHERN ILLINOIS. Central States Forest Expt. Sta. Notes 44, 2 pp., illus. [Processed.]
- (513) _____ AND CHAPMAN, A. G.
1948. TREE PLANTING IN THE CENTRAL, PIEDMONT, AND SOUTHERN APPALACHIAN REGIONS. U. S. Dept. Agr. Farmers' Bul. 1994, 39 pp., illus.
- (514) _____ AND DOWNS, A. A.
1946. MACHINE AND HAND DIRECT SEEDING OF PINE AND CEDAR IN THE PIEDMONT. Southeast. Forest Expt. Sta. Tech. Note 67, 10 pp. [Processed.]
- (515) MIROV, N. T.
1936. A NOTE ON GERMINATION METHODS FOR CONIFEROUS SPECIES. Jour. Forestry 34: 719-723.
- (516) _____
1946. VIABILITY OF PINE SEED AFTER PROLONGED COLD STORAGE. Jour. Forestry 44: 193-195.
- (517) MITCHELL, H. C.
1943. REGULATION OF FARM WOODLANDS BY RULE OF THUMB. Jour. Forestry 41: 243-248, illus.
- (518) MITCHELL, H. L.
1939. THE GROWTH AND NUTRITION OF WHITE PINE (PINUS STROBUS L.) SEEDLINGS IN CULTURES WITH VARYING NITROGEN, PHOSPHORUS, POTASSIUM AND CALCIUM. Black Rock Forest 13u1. 9, 135 pp., illus.
- (519) MITCHELL, J. W., AND BROWN, J. W.
1947. RELATIVE SENSITIVITY OF DORMANT AND GERMINATING SEEDS TO 2,4-D. Science 106: 266-267, illus.
- (520) MOOERS, C. A., WASHKO, J. B., AND YOUNG, J. B.
1948. EFFECT OF STRAW MULCH ON RECOVERY OF NITROGEN FROM NITRATE OF SODA AND AMMONIUM SULFATE APPLIED AS TOP-DRESSING. Soil Sci. 66: 399-400.
- (521) MOORE, E. B.
1936. SEEDLING-SPROUT GROWTH OF SHORTLEAF AND PITCH PINE IN NEW JERSEY. Jour. Forestry 34: 879-882.
- (522) _____
1940. FOREST AND WILDLIFE MANAGEMENT IN THE SOUTH JERSEY PINE BARRENS. Jour. Forestry 38: 27-30, illus.
- (523) MORRISS, D. J.
1939. EXPERIMENTAL PLANTING ON THE APALACHICOLA SAVANNAS. U. S. Forest Serv. Planting Quart. 8 (2): 21-22. [Processed.]
- (524) _____
1940. NOTES ON WILDLING PLANTING. U. S. Forest Serv. Planting Quart. 9 (2): 7-8. [Processed.]
- (525) _____ and MILLS, H. O.
1948. THE CONECHU LONGLEAF PINE SEED BED BURN. Jour. Forestry 46: 646-652, illus.
- (526) MOSS, A. E.
1937. PRUNING SECOND GROWTH HARDWOODS IN CONNECTICUT. Jour. Forestry 35: 823-828, illus.
- (527) MULLOY, G. A.
1946. RULES OF THUMB IN THINNING. Jour. Forestry 44: 735-737, illus.
- (528) _____
1946. THINNING RED PINE. Dominion Forest Serv. Silv. Res. Note 79, 29 pp. [Reviewed by T. F. Luther in Jour. Forestry 45: 571 1947.]
- (529) _____, E.
1934. DIE SCHRAGPFLANZUNG. Wochenblatt der Landesbauernschaft Bayern 124: 378-379. [Reviewed by H. I. Baldwin in Jour. Forestry 32: 900. 1934.]
- (530) MUNGER, T. T.
1947. GROWTH OF TEN REGIONAL RACES OF PONDEROSA PINE IN SIX PLANTATIONS. Pacific Northwest Forest Expt. Sta. Res. Notes 39, 4, 10p. [Processed.]
- (531) _____ AND MORRIS, W. G.
1936. GROWTH OF DOUGLAS FIR TREES OF KNOWN SEED SOURCE. U. S. Dept. Agr. Tech. Bul. 537, 40 pp., illus.
- (532) MUNNS, E. N., HOERNER, T. G., AND CLEMENTS, V. A.
1949. CONVERTING FACTORS AND TABLES OF EQUIVALENTS USED IN FORESTRY. U. S. Dept. Agr. Misc. Pub. 225, 48 pp., illus.
- (533) MUNTZ, H. H.
1944. EFFECTS OF COMPOST AND STAND DENSITY UPON LONGLEAF AND SLASH PINE NURSERY STOCK. Jour. Forestry 42: 114-118, illus.
- (534) _____
1947. ICE DAMAGE TO PINE PLANTATIONS. South. Lumberman 175 (2201): 142-145, illus.
- (535) _____
1948. CLOSE SPACING REDUCES FUSIFORM RUST. South. Forest Expt. Sta. South. Forestry Notes 53, p. 1. [Processed.]
- (536) _____
1948. GOOD SURVIVAL FROM MACHINE-PLANTED PINES. South. Forest Expt. Sta. South. Forestry Notes 57, p. 1. [Processed.]
- (537) _____
1948. PROFIT FROM THINNING VARIOUSLY SPACED LOBLOLLY PINE PLANTATIONS. South. Lumberman 177 (2225): 125-128, illus.
- (538) _____
1948. SLASH PINE VERSUS LOBLOLLY IN CENTRAL LOUISIANA. Jour. Forestry 46: 766-767.
- (539) _____
1950. DIRECT PINE SEEDING GIVES GOOD RESULTS IN LOUISIANA. Naval Stores Rev. 60 (36): 4.
- (540) _____
1950. DIRECT SEEDING GIVES GOOD RESULTS. South. Forest Expt. Sta. South. Forestry Notes 70, p. 3. [Processed.]
- (541) NEILSON-JONES, W.
1943. TREE NUTRITION AND SOIL FERTILITY. Jour. Forestry 41: 886-888.
- (542) NELSON, M. L.
1938. PRELIMINARY INVESTIGATIONS ON DRY, COLD STORAGE OF SOUTHERN PINE SEED. South. Forest Expt. Sta. Occas. Paper 78, 19 pp. [Processed.]
- (543) _____
1940. SUCCESSFUL STORAGE OF SOUTHERN PINE SEED FOR SEVEN YEARS. Jour. Forestry 38: 443-444.
- (544) _____
1941. POLYEMBRYONY IN SEEDS OF SOUTHERN PINES. Jour. Forestry 39: 959-960.
- (545) NELSON, R. A.
1939. PLANTATION SURVIVAL. U. S. Forest Serv. Planting Quart. 8 (2): 24. [Processed.]
- (546) _____
1940. LARGE SURVIVAL AFTER FIRE. U. S. Forest Serv. Planting Quart. 9 (2): 6. [Processed.]
- (547) NEWCOMER, F. R.
1933. MOISTURE-ABSORBING AND RETAINING CAPACITIES OF VARIOUS TREE PACKING MATERIALS. Jour. Forestry 31: 413-415, illus.
- (548) NEW YORK STATE COLLEGE OF AGRICULTURE, DEPARTMENT OF FORESTRY.
[n. d.] CHEMICAL CONTROL OF WOODY GROWTH. 1 p.
- (549) NICHOLAS I. J.
1940. TEXAS TOWN ANTS. U. S. Forest Serv. Planting Quart. 9 (2) :19-20. [Processed.]

- (550) NORTHEASTERN WOOD UTILIZATION COUNCIL.
1945. WOOD PRODUCTS FOR FERTILIZER. North-east. Wood Util. Council Bul. 7, 72 pp., illus.
- (551) OSBORNE, J. G., AND HARPER, V. L.
1937. THE EFFECT OF SEEDBED PREPARATION ON FIRST-YEAR ESTABLISHMENT OF LONGLEAF AND SLASH PINE. *JOUR. Forestry* 35: 63-68.
- (552) OSTROM, C. E.
1945. EFFECTS OF PLANT-GROWTH REGULATORS ON SHOOT DEVELOPMENT AND FIELD SURVIVAL OF FOREST-TREE SEEDLINGS. *Bot. Gaz.* 107: 139-183, illus.
- (553) OTIS, C. E.
1947. WEED CONTROL APPLICATION RIGS. *Down to Earth (Dow Chemical Co.)* 3 (3): 12-14, illus.
- (554) PARKER, J. R.
1939. GRASSHOPPERS AND THEIR CONTROL. U. S. Dept. Agr. Farmers' Bul. 1828, 38 pp., illus.
- (555) PARKER, K. W.
1943. CONTROL OF MESQUITE ON SOUTHWESTERN RANGES. U. S. Dept. Agr. Leaflet 234, 8 pp., illus.
- (556) PATERSON, D. D.
1939. STATISTICAL TECHNIQUE IN AGRICULTURAL RESEARCH. 263 pp., illus. New York.
- (557) PATON, R. R.
1929. THE RELATION OF SIZE OF SEEDLING TREES TO THEIR VIGOR. Ohio Agr. Expt. Sta. Bimo. Bul. 141: 191-194, illus.
- (558) PAUL, B. H.
1930. THE APPLICATION OF SILVICULTURE IN CONTROLLING THE SPECIFIC GRAVITY OF WOOD. U. S. Dept. Agr. Tech. Bul. 168, 20 pp., illus.
- (559) 1932. QUALITY VERSUS SIZE AS AN INDEX OF A PROFITABLE TREE: LOBLOLLY PINE. *Jour. Forestry* 30: 831-833, illus.
- (560) 1933. PRUNING FOREST TREES. *Jour. Forestry* 31: 563-566.
- (561) 1938. KNOTS IN SECOND-GROWTH PINE AND THE DESIRABILITY OF PRUNING. U. S. Dept. Agr. Misc. Pub. 307, 35 pp., illus.
- (562) 1946. STEPS IN THE SILVICULTURAL CONTROL OF WOOD QUALITY. *Jour. Forestry* 44: 953-958, illus.
- (563) PEARSON, G. A.
1934. GRASS, PINE SEEDLINGS AND GRAZING. *Jour. Forestry* 32: 545-555, illus.
- (564) 1945. SOIL TEMPERATURE VERSUS DROUGHT AS A FACTOR DETERMINING LOWER ALTITUDINAL LIMITS OF TREES IN THE ROCKY MOUNTAINS. By R. F. Daubenmire. *Bot. Gaz.* 105: 1-13. (Review.) *Jour. Forestry* 43: 615-616.
- (565) PEEVY, F. A.
1946. HOW TO KILL BLACKJACK OAKS WITH AMMATE: PRELIMINARY INSTRUCTIONS. *South. Forest Expt. Sta.*, 3 pp. [Processed.]
- (566) 1947. KILLING UNDESIRABLE HARDWOODS. *South. Lumberman* 175 (2201): 123-125, illus.
- (567) 1949. HOW TO CONTROL SOUTHERN UPLAND HARDWOODS WITH AMMATE. U. S. Dept. Agr. M-5296, 7 pp., illus.
- (568) PERRY, G. S., AND COOVER, C. A.
1933. SEED SOURCE AND QUALITY. *Jour. Forestry* 31: 19-25.
- (569) PESSIN, L. J.
1937. THE EFFECT OF NUTRIENT DEFICIENCY ON THE GROWTH OF LONGLEAF PINE SEEDLINGS. *South. Forest Expt. Sta. Occas. Paper* 65, 7 pp., illus. [Processed.]
- (570) 1939. DENSITY OF STOCKING AND CHARACTER OF GROUND COVER AS FACTORS IN LONGLEAF PINE REPRODUCTION. *Jour. Forestry* 37: 255-258, illus.
- (571) 1942. RECOMMENDATIONS FOR KILLING SCRUB OAKS AND OTHER UNDESIRABLE TREES. *South. Forest Expt. Sta. Occas. Paper* 102, 5 pp., illus. [Processed.]
- (572) 1944. STIMULATING THE EARLY HEIGHT GROWTH OF LONGLEAF PINE SEEDLINGS. *Jour. Forestry* 42: 95-98.
- (573) PHILLIPS, J. E.
1941. EFFECT OF DAY LENGTH ON DORMANCY IN TREE SEEDLINGS. *Jour. Forestry* 39: 55-59.
- (574) PINCK, L. A., ALLISON, F. E., AND GADDY, V. L.
1946. THE NITROGEN REQUIREMENT IN THE UTILIZATION OF CARBONACEOUS RESIDUES IN SOIL. *Amer. Soc. Agron. Jour.* 38: 410-420, illus.
- (575) ALLISON, F. E., AND GADDY, V. L.
1946. THE EFFECT OF STRAW AND NITROGEN ON THE YIELD AND QUANTITY OF NITROGEN FIXED BY SOYBEANS. *Amer. Soc. Agron. Jour.* 38: 421-431, illus.
- (576) PLANK, D. K.
1939. ROOT RESPONSE TO SLASH PINE SEEDLINGS TO INDOLEBUTYRIC ACID. *Jour. Forestry* 37: 497-498, illus.
- (577) POLIVKA, J. B., AND ALDERMAN, O. A.
1937. THE PROBLEM OF SELECTING THE DESIRABLE PINE SPECIES FOR FOREST PLANTING IS onto. *Jour. Forestry* 35: 832-835.
- (578) PORTER, R. H., DURRELL, M., AND ROHM, H. J.
1947. THE USE OF 2,3,5-TRIPHENYL-TETRAZOLIUM-CHLORIDE AS A MEASURE OF SEED GERMINABILITY. *Plant Physiol.* 22: 149-159, illus.
- (579) POWELL, G. M.
1948. A TREE PLANTING SPADE FOR A CRAWLER TRACTOR. *Jour. Forestry* 46: 278-281, illus.
- (580) PRESTON, J. F.
1939. RESULTS OF THE SOIL CONSERVATION SERVICE PROGRAM OF PLANTING TREES AND SHRUBS. *Jour. Forestry* 37: 19-22.
- (581) 1943. NOTES ON TREE PLANTING OF THE SOIL CONSERVATION SERVICE. *Jour. Forestry* 41: 285-287.
- (582) 1943. THE WOODLAND MANAGEMENT PROGRAM OF THE SOIL CONSERVATION SERVICE. *Jour. Forestry* 41: 402-405.
- (583) PRUITT, A. A.
1947. A STUDY OF THE EFFECTS OF SOILS, WATER TABLE, AND DRAINAGE ON THE HEIGHT GROWTH OF SLASH AND LOBLOLLY PINE PLANTATIONS ON THE HOFMANN FOREST. *Jour. Forestry* 45: 836.
- (584) RAYNER, M. C.
1948. BEHAVIOR OF CORSICAN PINE STOCK FOLLOWING DIFFERENT NURSERY TREATMENTS. (PILAEUS NIGRA VAR. CALABRICA SCHNEID.). *Forestry* 21: 204-216, illus.

- (585) READ, A. D.
1932. THE HAMMER TEST FOR JUDGING SEED. *Jour. Forestry* 30: 344.
- (586) ———
1940. A NURSERY PROBLEM. *Jour. Forestry* 38: 740-741.
- (587) REED, I. F.
1948. DISK PLOWS AND THEIR OPERATION. U. S. Dept. Agr. Farmers' Bul. 1992, 10 pp., illus.
- (588) REED, J. F.
1939. ROOT AND SHOOT GROWTH OF SHORTLEAF AND LOBLOLLY PINES IN RELATION TO CERTAIN ENVIRONMENTAL CONDITIONS. *Duke Univ. School Forestry Bul.* 4, 52 pp., illus.
- (589) REINEKE, L. H.
1933. PERFECTING A STAND-DENSITY INDEX FOR EVEN-AGED FORESTS. *Jour. Agr. Res.* 46: 627-638, illus.
- (590) ———
1942. EFFECT OF STOCKING AND SEED ON NURSERY DEVELOPMENT OF EASTERN WHITE PINE SEEDLINGS. *Jour. Forestry* 40: 577-578.
- (591) REYNOLDS, R. R.
1939. POSSIBLE RETURNS FROM PLANTED LOBLOLLY PINE. *Jour. Forestry* 37: 250-254.
- (592) RICH, J. H.
1935. A NEW FOREST PRUNING TOOL. *Jour. Forestry* 33: 1006-1007, illus.
- (593) RICHARDSON, E. C.
1945. THE EFFECT OF FERTILIZER ON STAND AND YIELD OF KUDZU ON DEPLETED SOILS. *Amer. Soc. Agron. Jour.* 37: 763-770, illus.
- (594) RIETZ, R. C.
1939. EFFECT OF FIVE KILN TEMPERATURES ON THE GERMINATIVE CAPACITY OF LONGLEAF PINE SEED. *Jour. Forestry* 37: 960-963, illus.
- (595) ———
1939. INFLUENCE OF KILN TEMPERATURES ON FIELD GERMINATION AND TREE PERCENT IN NORTHERN WHITE PINE. *Jour. Forestry* 37: 343-344.
- 596) ———
1941. KILN DESIGN AND DEVELOPMENT OF SCHEDULES FOR EXTRACTING SEED FROM CONES. U. S. Dept. Agr. Tech. Bul. 773, 70 pp., illus.
- (597) RIGHTER, F. I.
1945. PINUS: THE RELATIONSHIP OF SEED SIZE AND SEEDLING SIZE TO INHERENT VIGOR. *Jour. Forestry* 43: 131-137, illus.
- (598) RIKER, A. J., GRUENHA GEN, R. H., ROTH, L. F., AND BRENER, W. H.
1947. SOME CHEMICAL TREATMENTS AND THEIR INFLUENCE ON DAMPING-OFF, WEED CONTROL, AND WINTER INJURY OF RED PINE SEEDLINGS. *Jour. Agr. Res.* 74: 87-95.
- (599) ROBBINS, P. W.
1942. A GRADING AND COUNTING MACHINE FOR FOREST NURSERY SEEDLINGS. *Jour. Forestry* 40: 809-811, illus.
- (600) ——— GRIGSBY, B. H., AND CHURCHILL, B. R.
1947. REPORT ON CHEMICAL CONTROL FOR CONIFER SEEDLINGS AND TRANSPLANTS. *Mail. Agr. Expt. Sta. Quart. Bul.* 30 (2) : 237-240.
- (601) ROBERTS, E. G.
1936. GERMINATION AND SURVIVAL OF LONGLEAF PINE. *Jour. Forestry* 34: 884-885.
- (602) ROBERTS, R. H., AND STRUCKMEYER, B. E.
1946. THE EFFECT OF TOP ENVIRONMENT AND FLOWERING UPON TOP-ROOT RATIOS. *Plant Physiol.* 21: 332-344, illus.
- (603) ROBINSON, R. L.
1942. SOME ECOLOGICAL ASPECTS OF AFFORESTATION AND FORESTRY IN GREAT BRITAIN. *Forestry* 16: 1-12, illus. [Reviewed by A. C. Cline in *Jour. Forestry* 41: 925-927. 1943.]
- (604) ROE, E. I.
1948. VIABILITY OF WHITE PINE SEED AFTER 10 YEARS OF STORAGE. *Jour. Forestry* 46: 900-902.
- (605) ROESER, J., JR.
1932. TRANSPIRATION CAPACITY OF CONIFEROUS SEEDLINGS AND THE PROBLEM OF HEAT INJURY. *Jour. Forestry* 30: 381-395, illus.
- (606) ROSENDAHL, R., AND KORSTIAN, C. F.
1945. EFFECT OF FERTILIZERS ON LOBLOLLY PINE IN A NORTH CAROLINA NURSERY. *Plant Physiol.* 20 (1): 19-23.
- (607) ROSENKRANS, D. B.
1944. SLASH PINE PRODUCES VIABLE SEED NORTH OF ITS NATURAL RANGE. *Jour. Forestry* 42: 685.
- (608) Ross, C. R.
1942. A FORTY-YEAR OLD PLANTED LONGLEAF STAND. *Jour. Forestry* 40: 581-584, illus.
- (609) ———
1943. PRODUCTIVE WOODLANDS — A NEEDED SUPPORT FOR SOUTHERN FARMS. *Jour. Forestry* 41: 393-397.
- (610) ———
1948. THE SHORTEST STEP TO INCREASE OUR TIMBER SUPPLY. *Jour. Forestry* 46: 350-358.
- (611) ROTH, E. R., TOOLE, E. R., AND HEPTING, O. H.
1948. NUTRITIONAL ASPECTS OF THE LITTLELEAF DISEASE OF PINE. *Jour. Forestry* 46: 578-587, illus.
- (612) ROTH, L. F., AND RIKER, A. J.
1943. INFLUENCE OF TEMPERATURE, MOISTURE, AND SOIL REACTION ON THE DAMPING-OFF OF RED PINE SEEDLINGS BY PYTHIUM AND RHIZOCTONIA. *Jour. Agr. Res.* 67: 273-293, illus.
- (613) AND RIKER, A. J.
1943. LIFE HISTORY AND DISTRIBUTION OF PYTHIUM AND RHIZOCTONIA IN RELATION TO DAMPING-OFF OF RED PINE SEEDLINGS. *Jour. Agr. Res.* 67: 129-148, illus.
- (614) AND RIKER, A. J.
1943. SEASONAL DEVELOPMENT IN THE NURSERY OF DAMPING-OFF OF RED PINE SEEDLINGS CAUSED BY PYTHIUM AND RHIZOCTONIA. *Jour. Agr. Res.* 67: 417-431, illus.
- (615) ROWLAND, C. A., JR.
1948. BUD-PRUNING FOR BETTER LOGS. *South. Lumberman* 177 (2225): 142-143.
- (616) RUDOLF, P. O.
1937. LESSONS FROM PAST FOREST PLANTING IN THE LAKE STATES. *JOUR. Forestry* 35: 72-76.
- (617) ———
1939. WHY FOREST PLANTATIONS FAIL. *Jour. Forestry* 37: 377-383.
- (618) ———
1940. FURTHER COMMENTS ON "WHY FOREST PLANTATIONS FAIL". *Jour. Forestry* 38: 442-443.
- (619) ———
1948. HOW ABOUT OUR SEED SUPPLY? *JOUR. Forestry* 46: 741-743.
- (620) ———
1948. IMPORTANCE OF RED PINE SEED SOURCE. *Soc. Amer. Foresters Proc.* 1947: 384-398, illus.

- RUDOLF, P. O.
1948. LOCAL RED PINE SEED DEVELOPS BEST PLANTATIONS. Lake States Forest Expt. Sta. Tech. Notes 296, 2 pp. [Processed.]
1950. FOREST PLANTATIONS IN THE LAKE STATES. U. S. Dept. Agr. Tech. Bul. 1010, 171 pp., illus.
- AND GEVORKIAN'TZ, S. R.
1933. AFTER PLANTING-WHAT? Jour. Forestry 31: 441-442.
- ST. GEORGE, R. A.
1935. FOREST NURSERY SEEDLINGS SUBJECT TO ARSENICAL INJURY IN SOME SOILS. Jour. Forestry 33: 627-628.
- SAWYER, L. E.
1946. INDIANA STRIP-MINE PLANTINGS. Jour. Forestry 44: 19-21.
- SCHAFFNER, J. V., Jr.
1943. SAWFLIES INJURIOUS TO CONIFERS IN THE NORTHEASTERN STATES. Jour. Forestry 41: 580-588, illus.
- SCHANTZ-HANSEN, T.
1939. TEN-YEAR OBSERVATIONS ON THE THINNING OF FIFTEEN-YEAR-OLD RED PINE. Jour. Forestry 37: 963-966.
1945. THE EFFECT OF PLANTING METHODS ON ROOT DEVELOPMENT. Jour. Forestry 43: 447-448.
- SCHAVILJE, J. P.
1941. RECLAIMING ILLINOIS STRIP MINED COAL LANDS WITH TREES. Jour. Forestry 39: 714-719, illus.
- SCHMITZ, H.
1937. THE TYMPANIS CANCKER OF RED PINE. By John Raymond Hansbrough. Yale Univ. School Forestry B111. 43. (Review.) Jour. Forestry 35: 315-316.
- SCHINUR, G. L.
1934. PERFECTING A STAND-DENSITY INDEX FOR EVEN-AGED FORESTS. By L. H. Reineke. Jour. Agr. Res. 46: 627-638. (Review.) Jour. Forestry 32: 355-356.
- SCHOPMEYER, C. S.
1939. TRANSPIRATION AND PHYSICO-CHEMICAL PROPERTIES OF LEAVES AS RELATED TO DROUGHT RESISTANCE IN LOBLOLLY PINE AND SHORLEAF PINE. Plant Physiol. 14: 447-462, illus.
1940. SURVIVAL IN FOREST PLANTATIONS IN THE NORTHERN ROCKY MOUNTAIN REGION. Jour. Forestry 38: 16-24, illus.
- AND HELMERS, A. E.
1947. SEEDING AS A MEANS OF REFORESTATION IN THE NORTHERN ROCKY MOUNTAIN REGION. U. S. Dept. Agr. Cir. 772, 31 pp., illus.
- SCHREINER, E. J.
1938. IMPROVEMENT OF FOREST TREES. U. S. Dept. Agr. Yearbook 1937, Sep. 1599, 54 pp., illus.
- SCHUMACHER, F. X., AND CHAPMAN, R. A.
1948. SAMPLING METHODS IN FORESTRY AND RANGE MANAGEMENT. Duke Univ. School Forestry 13u1. 7 (rev.), 222 pp., illus.
- SENTELL, N. W.
1949. PALES WEEVIL DAMAGES PLANTATIONS IN LOUISIANA. Jour. Forestry 47: 741.
- SHAFER-SAFONOVA, E. Y., KALASHNIKOV A, M. I., AND KOSTROMINA, A. S.
1934. OPREDELENIE VSKHOZHESTI SEMI AN DREVESNYKH POROD METODOM OKRASHIVA NIA. [DETERMINATION OF THE GERMINATION CAPACITY OF FOREST TREE SEEDS BY THE DYEING METHOD.] [Reviewed by H. L. Shirley in Jour. Forestry 33: 640-641. 1935.
- (639) SHERRY, S. P.
1947. THE POTENTIALITIES OF GENETIC REST. IN SOUTH AFRICAN FORESTRY. WI I Empire Forestry Conf., 11 pp., illus. City Printing Works, Ltd., Pietermaritzburg, South Africa.
- (640) SHIRLEY, H. L.
1932. AN EXPERIMENTAL STUDY OF THE WATER RELATIONS OF SEEDLING CONIFERS WITH SPECIAL REFERENCE TO WILTING. By Robert Marshall. Ecol. Monog. 1:37-98. (Review.) Jour. Forestry 30: 520-521.
- (641) 1936. LETHAL HIGH TEMPERATURES FOR CONIFERS, AND THE COOLING EFFECT OF TRANSPIRATION. Jour. Agr. Res. 53: 239-258, illus.
- (642) 1937. DIRECT SEEDING IN THE LAKE STATES. Jour. Forestry 35: 379-387.
- (643) 1939. SOME NEW ASPECTS OF SEED CERTIFICATION. [By H. I. Baldwin. Jour. Forestry 37: 28-34.] (Comments.) Jour. Forestry 37: 35-36.
- (644) 1939. THE GROWTH AND NUTRITION OF WHITE PINE (PINUS STROBUS L.) SEEDLINGS IN CULTURES WITH VARYING NITROGEN, PHOSPHORUS, POTASSIUM AND CALCIUM. By H. L. Mitchell. Black Rock Forest 13111.9. (Review.) Jour. Forestry 37: 587-588.
- (645) — 1945. REPRODUCTION OF UPLAND CONIFERS IN THE LAKE STATES AS AFFECTED BY ROOT COMPETITION AND LIGHT. Amer. Midland Nat. 33: 537-612, illus.
- (646) AND MEULI, L. J.
1938. INFLUENCE OF FOLIAGE SPRAYS ON DROUGHT RESISTANCE OF CONIFERS. Plant Physiol. 13: 399-406, illus.
- (647) AND MEULI, L. J.
1939. INFLUENCE OF MOISTURE SUPPLY ON DROUGHT RESISTANCE OF CONIFERS. Jour. Agri. Res. 59: 1-21. illus.
- (648) Snow, S. B.
1924. SOME RESULTS OF EXPERIMENTAL FOREST PLANTING IN NORTHERN CALIFORNIA. Ecology 5: 83-94.
- (649) 1930. FOREST NURSERY AND PLANTING PRACTICE IN THE CALIFORNIA PINE REGION. U. S. Dept. Agr. Cir. 92, 75 pp., illus.
- (650) SIGGERS.
1932. THE BROWN-SPOT NEEDLE BLIGHT OF LONGLEAF PINE SEEDLINGS. Jour. Forestry 30: 579-593, illus.
- (651) 1934. OBSERVATIONS ON THE INFLUENCE OF FIRE ON THE BROWN-SPOT NEEDLE BLIGHT OF LONGLEAF PINE SEEDLINGS. Jour. Forestry 32: 556-562, illus.
- (652) 1944. THE BROWN-SPOT NEEDLE BLIGHT OF PINE SEEDLINGS. U. S. Dept. Agr. Tech. Bul. 870, 36 pp., illus.
- (653) 1945. CONTROLLING THE BROWN-SPOT NEEDLE BLIGHT OF LONGLEAF PINE BY PRESCRIBED BURNING. Naval Stores Rev. 55 (25): 4, 8.
- (654) 1946. FUSIFORM RUST, A THREAT TO SLASH PINE PLANTATIONS. Miss. Agr. Expt. Sta. Inform. Sheet 362, 2 pp., illus.

- (655) SIGGERS, P. V.
1947. TEMPERATURE REQUIREMENTS FOR GERMINATION OF SPORES OF CRONARTIUM FUSIFORME. *Phytopathology* 37: 855-864, illus.
- (656) ———
1948. WEATHER AND THE SOUTHERN FUSIFORM RUST. *Forest Farmer* 8 (2): 8, 10, illus.
- (657) ———
1949. WEATHER AND OUTBREAKS OF THE FUSIFORM RUST OF SOUTHERN PINES. *Jour. Forestry* 47: 802-806.
- (658) AND LINDGREN, R. M.
1947. AN OLD DISEASE-A NEW PROBLEM. *South. Lumberman* 175 (2201): 172-175, illus.
- (659) SILVER, J., AND MOORE, A. W.
1941. MOLE CONTROL. U. S. Dept. Int. Conserv. Bul. 16, 17 pp., illus.
- (660) SIMERLY, N. G. T.
1936. CONTROLLED BURNING IN LONGLEAF PINE SECOND-GROWTH TIMBER. *Jour. Forestry* 34: 671-673.
- (661) SKINNER, J. J., NELSON, W. L., AND WHITTAKER, C. W.
1945. EFFECT OF SALT INDEX, ANALYSIS, RATE, AND PLACEMENT OF FERTILIZER ON COTTON. *Amer. Soc. Agron. Jour.* 37: 677-688, illus.
- (662) SLAVIN, A. D.
1947. SOIL CONSERVATION FOR NURSERIES. *Amer. Nurseryman* 86 (4): 7-8, 49-58, illus.
- (663) SLEETH, B.
1940. MORTALITY OF SLASH PINE SEEDLINGS INFECTED BY CRONARTIUM FUSIFORME. *South. Forest Expt. Sta. South. Forestry Notes* 35, pp. 1-2. [Processed.]
- (664) ———
1940. RUSTY SEEDLINGS. U. S. Forest Serv. *Planting Quart.* 9 (2): 18-19. [Processed.]
- (665) ———
1943. FUSIFORM RUST CONTROL IN FOREST-TREE NURSERIES. *Phytopathology* 33: 33-44 illus.
- (666) SMITH, B. F.
1932. FORESTRY AT ELIZABETH, LOUISIANA. *Jour. Forestry* 30: 312-316.
- (667) SMITH, C. F., AND ALDOUS, S. E.
1947. THE INFLUENCE OF MAMMALS AND BIRDS IN RETARDING ARTIFICIAL AND NATURAL RESEEDING OF CONIFEROUS FORESTS IN THE UNITED STATES. *Jour. Forestry* 45: 361-369.
- (668) SMITH, E. V., AND MAYTON, E. L.
1938. NUT GRASS ERADICATION STUDIES: II. THE ERADICATION OF NUT GRASS, CYPERUS ROTUNDUS L., BY CERTAIN TILLAGE TREATMENTS. *Amer. Soc. Agron. Jour.* 30: 18-21.
- (669) ———
1942. NUT GRASS ERADICATION STUDIES: III. THE CONTROL OF NUT GRASS, CYPERUS ROTUNDUS L., ON SEVERAL SOIL TYPES BY TILLAGE. *Amer. Soc. Agron. Jour.* 34: 151-159.
- (670) SMITH, F. B., STEVENSON, W. H., AND BROWN, P. E.
1930. THE PRODUCTION OF ARTIFICIAL FARM MANURES. *Iowa Agr. Expt. Sta. Res. Bul.* 126, pp. 165-195, illus.
- (671) SMITH, H. P.
1948. FARM MACHINERY AND EQUIPMENT. Ed. 3, 520 pp., illus. New York.
- (672) SMITH, J. E., JR., AND WEBSTER, C. B.
1948. ON DEWINGING TREE SEED BY HAMMERMILL. *Jour. Forestry* 46: 926-928, illus.
- (673) SMITH, L. F.
1947. EARLY RESULTS OF A LIBERATION CUTTING IN A PINE-HARD WOOD STAND IN NORTHERN LOUISIANA. *Jour. Forestry* 45: 278-282.
- (674) SMITH, M. B., JR.
1949. MACHINE TREE PLANTING. Master of forestry thesis, Univ. Mich., 118 pp., illus. [Processed.]
- (675) SMITH, M. R.
1939. THE TEXAS LEAF-CUTTING ANT (ATTA TEXANA BUCKLEY) AND ITS CONTROL IN THE KISATCHIE NATIONAL FOREST OF LOUISIANA. *South. Forest Expt. Sta. Occas. Paper* 84, 11 pp., illus. [Processed.]
- (676) SNEDECOR, G. W.
1946. STATISTICAL METHODS. Ed. 4, 485 pp., illus. Ames, Iowa.
- (677) SNYDER, T. E.
1936. REPORT ON DAMAGE TO YOUNG PINES BY LEAF-CUTTING ANTS (ATTA SP.) AND THE RESULTS OF CONTROL OPERATIONS ON THE KISATCHIE NATIONAL FOREST. U. S. Forest Serv. *Planting Quart.* 5 (3): 25-27. [Processed.]
- (678) ———
1937. DAMAGE TO YOUNG PINES BY A LEAF-CUTTING ANT, ATTA TEXANA BUCKLEY, IN LOUISIANA. *La. Conserv. Rev.* 6 (1): 14-17, illus.
- (679) ———
1940. THE BROWNING OF THE NEEDLES OF YOUNG YELLOW PINE TREES IN THE GULF STATES BY A LEAF-FEEDING BEETLE (COLASPIS PINI BARBER). *South. Lumberman* 160 (2020): 46, illus.
- (680) SOCIETY OF AMERICAN FORESTERS.
1950. FORESTRY TERMINOLOGY. 93 pp.
- (681) SOCIETY OF AMERICAN FORESTERS, NEW ENGLAND SECTION, COMMITTEE ON SILVICULTURE.
1939. THE RELATION OF STAND COMPOSITION TO CROP SECURITY. *Jour. Forestry* 37: 49-54.
- (682) SOCIETY OF AMERICAN FORESTERS, NEW YORK SECTION, COMMITTEE ON TECHNICAL PRACTICES.
1932. TECHNICAL FOREST PRACTICES IN NEW YORK REFORESTATION WORK. *Jour. Forestry* 30: 791-799, illus.
- (683) SOUTHEASTERN FOREST EXPERIMENT STATION.
1948. LITTLELEAF LOSSES. *Res. News* 2: 1. [Processed.]
- (684) SPAETH, J. N., AND AFANASIEV, M.
1939. THE EFFECT OF STERILIZATION WITH CALCIUM HYPOCHLORITE ON GERMINATION OF CERTAIN SEEDS. *Jour. Forestry* 37: 371-372.
- (685) SPARHAWK, W. N.
1935. ARTIFICIAL PRUNING IN CONIFEROUS PLANTATIONS. By Ralph C. Hawley and Robert T. Clapp. *Yale Univ. School Forestry Bul.* 39. (Review.) *Jour. Forestry* 33: 632.
- (686) SPIERS, J. F.
1932. THE SURVIVAL AND EARLY GROWTH OF PLANTED LOBLOLLY PINE IN CLARKE, HART AND BANKS COUNTIES, GEORGIA. 8 pp., illus. [Reprint from 1932 Cypress Knee, Ga. State Col. Agr.]
- (687) SPURR, S. H.
1944. EFFECT OF SEED WEIGHT AND SEED ORIGIN ON THE EARLY DEVELOPMENT OF EASTERN WHITE PINE. *Arnold Arboretum Jour.* 25: 467-480, illus.
- (688) ———
1948. ROW THINNING. *SOC. Amer. Foresters Proc.* 1947: 370-377.

- (689) SQUIRES, J. W.
1947. PRESCRIBED BURNING IN FLORIDA. *Jour. Forestry* 45: 815-819.
- (690) STAHELIN, R.
1946. THE CONVERSION OF HARDWOOD TO PINE STANDS IN ALABAMA. *Ala. Acad. Sci. Jour.* 18: 58-59.
- (691) ———
1948. PLANTATION SPACING AND WOOD PRODUCTION. *South, Forest Expt. Sta. South. Forestry Notes* 56, pp. 3-4. [Processed.]
- (692) STEPHENS, E. P., AND SPURR, S. H.
1948. THE IMMEDIATE RESPONSE OF RED PINE TO THINNING AND PRUNING. *Soc. Amer. Foresters Proc.* 1947: 353-369, illus.
- (693) STEPHENSON, R. E., AND SCHUSTER, C. E.
1946. STRAW MULCH FOR SOIL IMPROVEMENT. *S011 Sci.* 61: 219-224.
- (694) STEVENS, O. A.
1935. GERMINATION STUDIES ON AGED AND INJURED SEEDS. *Jour. Agr. Res.* 51: 1093-1106, illus.
- (695) STEVENS, T. D., AND BELL, L. E.
1945. MICHIGAN STATE COLLEGE REFORESTATOR. *Mich. Agr. Expt. Sta. Quart. Bul.* 28: 107-110, illus.
- (696) STEVENSON, D. D., AND BARTOO, R. A.
1940. CONIFEROUS FOREST PLANTINGS IN CENTRAL PENNSYLVANIA. *Pa. State Col. Bul.* 394, 20 pp., illus.
- (697) STOCKWELL, W. P.
1939. PREEMBRYONIC SELECTION IN THE PINES. *Jour. Forestry* 37: 541-543, illus.
- (698) STODDARD, H. L.
1937. USE OF MECHANICAL BRUSH-CUTTERS IN WILDLIFE MANAGEMENT. *Jour. Wildlife Mangt.* 1: 42-44, illus.
- (699) STOECKELER, J. H.
1947. PLANTING POORLY DRAINED WET SITES. *Lake States Forest Expt. Sta. Tech. Notes* 276, 1 p. [Processed.]
- (700) ———
1948. KILLING NURSERY WEEDS WITH OIL SPRAYS. *Lake States Forest Expt. Sta. Tech. Notes* 290, 1 p. [Processed.]
- (701) ——— AND SUMP, A. W.
1940. SUCCESSFUL DIRECT SEEDING OF NORTHERN CONIFERS ON SHALLOW-WATER-TABLE AREAS. *Jour. Forestry* 38: 572-577, illus.
- (702) STONE, E. L., JR.
1944. EFFECT OF FIRE ON TAPER OF LONGLEAF PINE. *Jour. Forestry* 42: 607.
- (703) ——— AND SMITH, L. F.
1941. HAIL DAMAGE IN SECOND-GROWTH LONGLEAF PINE. *Jour. Forestry* 39: 1033-1035, illus.
- (704) STORY, H. D., JR.
1940. NURSERY BED SHAPER. *Jour. Forestry* 38: 515-517, illus.
- (705) STUCKEY, H. P.
1942. THREE PINES IN THE PIEDMONT. *Jour. Forestry* 40: 885.
- (706) SWARTHOUT, P. A.
1941. SOME OBSERVATIONS ON THE USE OF SLASH PINE WILDINGS AS PLANTING STOCK. *Slash Pine Cache* 4: 27-31, illus.
- (707) TENNESSEE VALLEY AUTHORITY, FORESTRY RELATIONS DEPARTMENT.
1947. 1947 ANNUAL REPORT. 24 pp., illus. [Processed.]
- (708) THOMAS, G. M., AND STADEL, E. L.
1948. INCREASING SURVIVAL OF PLANTED CONIFERS WITH S/V CEREMUL C. *Jour. Forestry* 46: 764-766.
- (709) THOMPSON, L. G., JR., AND SMITH, F. B.
1947. ORGANIC MATTER IN FLORIDA SOILS. *Fla. Agr. Expt. Sta. Bul.* 433, 15 pp.
- (710) TIDMORE, J. W., AND VOLK, N. J.
1945. THE EFFECT OF PLOWING UNDER AND THE TIME OF PLOWING UNDER LEGUMES ON THE CONSERVATION OF NITROGEN. *Amer. Soc. Agron. Jour.* 37: 1005-1010.
- (711) TINSLEY, S. L.
1938. DIRECT SEEDING IN THE NORTHERN ROCKY MOUNTAIN. *Jour. Forestry* 36: 1158-1160, illus.
- (712) ———
1939. DIRECT SEEDING — A REVIVAL. *Jour. Forestry* 37: 888-890.
- (713) TIPPETT, L. H. C.
1937. THE METHODS OF STATISTICS. Ed. 2, 280 pp., illus. London.
- (714) TOOLE, E. H.
1939. GERMINATION EQUIPMENT AND SUPPLIES. *U. S. Bur. Plant Indus.*, 4 pp. [Processed.]
- (715) ———
1939. PHYSIOLOGICAL PROBLEMS INVOLVED IN SEED DORMANCY. *U. S. Bur. Plant Indus.* 9 pp. [Processed.]
- (716) TOOLF, V. K., AND GORMAN, E. A.
1948. VEGETABLE-SEED STORAGE AS AFFECTED BY TEMPERATURE AND RELATIVE HUMIDITY. *U. S. Dept. Agr. Tech. Bul.* 972, 24 pp., illus.
- (717) TOOLE, E. R.
1939. RELATION OF INCIDENCE OF NEEDLE DISEASE IN LOBLOLLY PINE PLANTATIONS TO CERTAIN PHYSICAL PROPERTIES OF THE SOIL. *Jour. Forestry* 37: 13-18.
- (718) TOUMEY, J. W., AND KORSTIAN, C. F.
1942. SEEDING AND PLANTING IN THE PRACTICE OF FORESTRY. Ed. 3, 520 pp., illus. New York.
- (719) TRENK, F. B.
1944. TREE PLANTING MACHINE TO SPEED REFORESTATION. (Reprinted, from *Wis. Conserv. Dept. Bul. for March* 1944.) 4 pp., illus.
- (720) ——— AND BRUHN, H. D.
1947. DESIGN AND USE OF MECHANICAL TREE PLANTERS. *Jour. Forestry* 45: 408-413, illus.
- (721) TROUP, R. S.
1932. EXOTIC FOREST TREES IN THE BRITISH EMPIRE. 259 pp., illus. Oxford.
- (722) TRYON, E. H.
1948. EFFECT OF CHARCOAL ON CERTAIN PHYSICAL, CHEMICAL, AND BIOLOGICAL PROPERTIES OF FOREST SOILS. *Ecol. Monog.* 18: 81-115, illus.
- (723) TUKEY, H. B.
1946. NEW THINGS IN PLANT SCIENCE. *Amer. Nurseryman* 84 (2): 14, 54-55, illus.
- (724) TURK, L. M.
1943. THE EFFECT OF SAWDUST ON PLANT GROWTH. *Mich. State Agr. Expt. Sta. Quart. Bul.* 26: 10-22, illus.
- (725) TURNER, A. W., AND JOHNSON, E. J.
1948. MACHINES FOR THE FARM, RANCH, AND PLANTATION. 793 pp., illus. New York.
- (726) TURNER, L. M.
1936. RELATIVE EFFICIENCY OF ROOTS AND TOPS OF PLANTS IN PROTECTING THE SOIL FROM EROSION. By Joseph Kramer and J. E. Weaver. *Nebraska Univ., Conserv. and Soil Survey Bul.* 12. (Review.) *Jour. Forestry* 34: 638-639.
- (727) ———
1937. GROWTH OF SECOND-GROWTH PINE ON THE COASTAL PLAIN SOILS OF ARKANSAS. *Ark. Agr. Expt. Sta. Bul.* 342, 52 pp. [Reviewed by M. H. Bruner in *Jour. Forestry* 35: 1076. 1937.]

- (728) TURNER, L. M.
1937. SOME SOIL CHARACTERS INFLUENCING THE DISTRIBUTION OF FOREST TYPES AND RATE OF GROWTH OF TREES IN ARKANSAS. *Jour. Forestry* 35: 5-11.
- (729) ———
1938. SOIL PROFILE CHARACTERISTICS OF THE PINE-GROWING SOIL OF THE COASTAL PLAIN REGION OF ARKANSAS. *Ark. Agr. Expt. Sta. Bul.* 361, 52 pp., illus. [Reviewed by J. T. Auten in *Jour. Forestry* 37: 354-355, 1939.]
- (730) UEBERSEZIG, M.
1947. SUCCESSFUL STORAGE OF SLASH PINE SEED FOR FIFTEEN YEARS. *JOUR. Forestry* 45: 825-826.
- (731) UMLAND, C. B.
1946. NURSERY WEEDING COSTS REDUCED BY MECHANICAL CULTIVATION. *Jour. Forestry* 44: 379-380, illus.
- (732) U. S. DEPARTMENT OF AGRICULTURE.
1938. SOILS AND MEN. *Agr. Yearbook* 1938, 1232 pp., illus.
- (733) ———
1941. CLIMATE AND MAN. *Agr. Yearbook* 1941, 1248 pp., illus.
- (734) ———
1949. AGRICULTURAL STATISTICS, 1948. 752 pp.
- (735) U. S. FOREST SERVICE.
1948. WOODY-PLANT SEED MANUAL. U. S. Dept. Agr. Misc. Pub. 654, 416 pp., illus.
- (736) ———
1939. PLANTING HANDBOOK, REGION 8. 124 pp., illus. [Processed.]
- (737) U. S. PRODUCTION AND MARKETING ADMINISTRATION.
1946. RULES AND REGULATIONS UNDER THE FEDERAL SEED ACT. U. S. Dept. Agr., Prod. Market. Admin., Serv. and Regulat. Announc. 156, 48 pp.
- (738) VAUGHN, W. T.
1934. FIRE CONTROL IN THINNED AREAS. *Jour. Forestry* 32: 883-885.
- (739) VEIHMEYER, F. J., AND HENDRICKSON, A. H.
1948. SOIL DENSITY AND ROOT PENETRATION. *Soil Sci.* 65: 487-493.
- (740) VILJOEN, J. A., AND FRED, E. B.
1924. THE EFFECT OF DIFFERENT KINDS OF WOOD AND OF WOOD PULP CELLULOSE ON PLANT GROWTH. *Soil Sci.* 17: 199-211, illus.
- (741) WAHLENBERG, W. G.
1928. EXPERIMENTS WITH CLASSES OF STOCK SUITABLE FOR FOREST PLANTING IN THE NORTHERN ROCKY MOUNTAINS. *Jour. Agr. Res.* 36: 977-1000, illus.
- (742) ———
1929. RELATION OF QUANTITY OF SEED SOWN AND DENSITY OF SEEDLINGS TO THE DEVELOPMENT AND SURVIVAL OF FOREST PLANTING STOCK. *Jour. Agr. Res.* 38: 219-227, illus.
- (743) ———
1930. EXPERIMENTS IN THE USE OF FERTILIZERS IN GROWING FOREST PLANTING MATERIAL AT THE SAVENAC NURSERY. U. S. Dept. Agr. Cir. 125, 38 pp., illus.
- (744) ———
1934. DENSE STANDS OF REPRODUCTION AND STUNTED INDIVIDUAL SEEDLINGS OF LONGLEAF PINE. *South. Forest Expt. Sta. Occas. Paper* 39, 16 pp., illus. [Processed.]
- (745) ———
1935. EFFECT OF FIRE AND GRAZING ON SOIL PROPERTIES AND THE NATURAL REPRODUCTION OF LONGLEAF PINE. *JOUR. Forestry* 33: 331-337.
- (746) WAHLENBERG, W. G.
1946. LONGLEAF PINE. 429 pp., illus. Washington, D. C.
- (747) ———
1948. EFFECT OF FOREST SHADE AND OPENINGS ON LOBLOLLY PINE SEEDLINGS. *Jour. Forestry* 46: 832-834, illus.
- (748) WAKELEY, P. C.
1929. PLANTING SOUTHERN PINE. U. S. Dept. Agr. Leaflet 32, 8 pp., illus.
- (749) ———
1932. PEAT MATS FOR GERMINATION TESTS OF FOREST TREE SEEDS. *Science* 76: 627-628, illus.
- (750) ———
1935. ARTIFICIAL REFORESTATION IN THE SOUTHERN PINE REGION. U. S. Dept. Agr. Tech. Bul. 492, 115 pp., illus.
- (751) ———
1935. NOTES ON THE LIFE CYCLE OF THE NANTUCKET TIP MOTH RHYACIONIA FRUSTRANA COMST. IN SOUTHEASTERN LOUISIANA. *South. Forest Expt. Sta. Occas. Paper* 45, 8 pp., illus. [Processed.]
- (752) ———
1938. PLANTING SOUTHERN PINES. U. S. Dept. Agr. Leaflet 159, 8 pp., illus.
- (753) ———
1941. F. O. BATEMAN. *Jour. Forestry* 39: 950.
- (754) ———
1944. GEOGRAPHIC SOURCE OF LOB LOLLY PINE SEED. *Jour. Forestry* 42: 23-32, illus.
- (755) ———
1945. HOW MUCH FOREST PLANTING HAVE WE TO DO? *South. Lumberman* 171 (2153): 163-167, illus.
- (756) ———
1947. LOBLOLLY PINE SEED PRODUCTION. *Jour. Forestry* 45: 676-677.
- (757) ———
1949. PHYSIOLOGICAL GRADES OF SOUTHERN PINE NURSERY STOCK. *Soc. Amer. Foresters Proc.* 1948: 311-322..
- (758) ——— AND CHAPMAN, R. A.
1937. A METHOD OF STUDYING THE FACTORS AFFECTING INITIAL SURVIVAL IN FOREST PLANTATIONS. *South. Forest Expt. Sta. Occas. Paper* 69, 19 pp., illus. [Processed.]
- (759) ——— AND MUNTZ, H. H.
1947. EFFECT OF PRESCRIBED BURNING ON HEIGHT GROWTH OF LONGLEAF PINE. *Jour. Forestry* 45: 503-508, illus.
- (760) WALLACE, W. G.
1940. DIRECT SEEDING OF LONGLEAF PINE INDICATED AS A PRACTICAL METHOD OF REFORESTATION. *Jour. Forestry* 38: 289.
- (761) WALTER, E. V., SEATON, L., AND MATHEWSON, A. A.
1938. THE TEXAS' LEAF-CUTTING ANT AND ITS CONTROL. U. S. Dept. Agr. Cir. 494, 19 pp., illus.
- (762) WALTON, R. It., AND WHITEHEAD, F. E.
1945. TESTS OF INGREDIENTS OF GRASSHOPPER BAIT. *Jour. Econ. Ent.* 38: 452-457.
- (763) WALTON, W. R.
1946. CUTWORMS AND THEIR CONTROL IN CORN AND OTHER CEREAL CROPS. U. S. Dept. Agr. Farmers' Bid. 730 rev., 7 pp., illus.
- (764) WARD, R. D.
1925. THE CLIMATES OF THE UNITED STATES. 518 pp., illus. New York.
- (765) W ARE, L. M., AND STAHELIN, R.
1946. HOW FAR APART SHOULD PINES BE PLANTED? *South. Lumberman* 173 (2177): 191-193, illus.
- (766) ——— AND STAHELIN, R.
1948. GROWTH OF SOUTHERN PINE PLANTATIONS AT VARIOUS SPACINGS. *Jour. Forestry* 46: 267-274, illus.

- (767) WASSON, R. A., AND PERCY, J. F.
1942. ALLYCE CLOVER (*ALYSICARPUS VAGINALIS*).
La. State Univ. Agron. Ser. 12, 2 pp.
- (768) WAY, R. D., AND MAKI, T. E.
1946. EFFECTS OF PRE-STORAGE TREATMENT OF
HARDWOOD AND PINE SEEDLINGS WITH
 α -NAPHTHALENEACETIC ACID. *Bot. Gaz.*
108: 219-232, illus.
- (769) WEAVER, M. M., AND FISHEL, R. N.
1944. TWO HOME-MADE TREE PLANTERS. *Soil
Conserv.* 10: 71-72, illus.
- (770) WEAVER, R. J.
1947. REACTION OF CERTAIN PLANT GROWTH REG-
ULATORS WITH ION EXCHANGERS. *Sci-
ence* 106: 268-270.
- (771) WEDDELL, D. J.
1935. A SEMI-AUTOMATIC SPRINKLING SYSTEM FOR
THE SMALL NURSERY. *Jour. Forestry* 33:
691-692, illus.
- (772) 1935. VIABLE SEED FROM NINE-YEAR-OLD SOUTH-
ERN PINE. *JOIE. Forestry* 33: 902.
- (773) 1939. EXTENDING THE NATURAL RANGE OF SLASH
PINE IN ALABAMA. *Jour. Forestry* 37:
342-343, illus.
- (774) WEIDMAN, R. H.
1939. EVIDENCES OF RACIAL INFLUENCE IN A 25-
YEAR TEST OF *PONDEROSA* PINE. *JOUR.
Agr. Res.* 59: 855-887, illus.
- (775) WEIHING, R. M., AND HOERNER, J. L.
1947. GRASSHOPPER CONTROL WITH DUSTS AND
SPRAYS FOR PROTECTION OF EXPERIMEN-
TAL PLOTS. *Amer. Soc. Agron. Jour.* 39:
346-348.
- (776) WELCH, J. F.
1937. RABBIT CONTROL IN RELATION TO SLASH
PINE SEEDLINGS, KISATCHIE NATIONAL
FOREST, ALEXANDRIA, LOUISIANA. U. S.
Bur. Biol. Survey, 11 pp., illus. [Proc-
essed.]
- (777) WHITTAKER, C. W.
1949. MIXING FERTILIZERS ON THE FARM. U. S.
Dept. Agr. Farmers' Bul. 2007, 13 pp.,
illus.
- (778) WILCOXON, F.
1947. PROBABILITY TABLES FOR INDIVIDUAL COM-
PARISONS BY RANKING METHODS. *Biomet-
rics* 3: 119-122.
- (779) 1947. SOME RAPID APPROXIMATE STATISTICAL
PROCEDURES. 13 pp. American Cyana-
mid Co., Stamford, Conn.
- (780) WILDE, S. A.
1934. SOIL REACTION IN RELATION TO FORESTRY
AND ITS DETERMINATION BY SIMPLE
TESTS. *Jour. Forestry* 32: 411-418,
illus.
- (781) 1935. THE SIGNIFICANCE OF SOIL TEXTURE IN
FORESTRY, AND ITS DETERMINATION BY A
RAPID FIELD METHOD. *Jour. Forestry* 33:
503-508, illus.
- (782) 1937. RECENT FINDINGS PERTAINING TO THE USE
OF SULFURIC ACID FOR THE CONTROL OF
DAMPING-OFF DISEASE. *Jour. Forestry*
35: 1106-1110.
- (783) 1946. FOREST SOILS AND FOREST GROWTH. 241 pp.,
illus. Waltham, Mass.
- (784) 1946. SOIL-FERTILITY STANDARDS FOR GAME FOOD
PLANTS. *Jour. Wildlife Mangt.* 10: 77-
81.
- (785) WILDE, S. A. AND ALBERT, A. R.
1942. EFFECT OF PLANTING METHODS ON SURVIVAL
AND GROWTH OF PLANTATIONS ON WELL-
DRAINED SANDY SOILS OF CENTRAL WIS-
CONSIN. *Jour. Forestry* 40: 560-562,
illus.
- (786) AND KOPITKE, J. C.
1940. BASE EXCHANGE PROPERTIES OF NURSERY
SOILS AND THE APPLICATION OF POTASH
FERTILIZERS. *Jour. Forestry* 38: 330-
332, illus.
- (787) NALBANDOV, O. G., AND Yu, T. M.
1948. ASH, PROTEIN, AND ORGANO-SOLUBLES OF
JACK PINE SEEDLINGS IN RELATION TO SOIL
FERTILITY. *Jour. Forestry* 46: 829-831.
- (788) AND PATZER, W. E.
1940. THE ROLE OF SOIL ORGANIC MATTER IN RE-
FORESTATION. *Amer. Soc. Agron. Jour.*
32: 551-562, illus.
- (789) AND ROSENDAHL, R. O.
1945. VALUE OF POTASSIUM FELDSPAR AS A FERTIL-
IZER IN FOREST NURSERIES. *Jour. For-
estry* 43: 366-367, illus.
- (790) TRENK, F. B., AND ALBERT, A. R.
1942. EFFECT OF MINERAL FERTILIZERS, PEAT AND
COMPOST ON THE GROWTH OF RED PINE
PLANTATIONS. *Jour. Forestry* 40: 481-
484, illus.
- (791) AND VOIGT, G. K.
1948. SPECIFIC GRAVITY OF THE WOOD OF JACK
PINE SEEDLINGS RAISED UNDER DIFFERENT
LEVELS OF SOIL FERTILITY. *Jour. For-
estry* 46: 521-523, illus.
- (792) AND WITTENKAMP, R.
1939. THE PHOSPHATE AND POTASH STARVATION OF
FOREST SEEDLINGS AS A RESULT OF THE
SHALLOW APPLICATION OF ORGANIC MAT-
TER. *Jour. Forestry* 37: 333-335, illus.
- (793) ——— WITTENKAMP, R., STONE, E. L., AND GALLO-
WAY, H. M.
1940. EFFECT OF HIGH RATE FERTILIZER TREAT-
MENTS OF NURSERY STOCK UPON ITS
SURVIVAL AND GROWTH IN THE FIELD.
Jour. Forestry 38: 806-809, illus.
- (794) WILKINSON, G. M.
1948. THE RED DIRT PASTURE. *South. Lumber-
man* 177 (2225): 145-146, illus.
- (795) WILLIAMS, J. E.
1944. BLITZING THE BRUSH IN FLORIDA. *Soil
Conserv.* 9: 208, 213, illus.
- (796) WILSON, F. G.
1946. NUMERICAL EXPRESSION OF STOCKING IN
TERMS OF HEIGHT. *JOIE. Forestry* 44:
758-761, illus.
- (797) WILSON, J. K., AND CHOUDHRI, R. S.
1948. THE EFFECT OF BENZENE HEXACHLORIDE
ON SOIL ORGANISMS. *Jour. Agr. Res.*
77: 25-32.
- (798) WILSON, R. M.
1939. MULCHING FALL PLANTED PINE ON THE
HOOSIER. U. S. Forest Serv. Planting
Quart. 8 (1): 19. [Processed.]
- (799) WISECUP, C. B., AND HAYSLIP, N. C.
1943. CONTROL OF MOLE CRICKETS BY USE OF
POISONED BAIT. U. S. Dept. Agr.
Leaflet 237, 6 pp., illus.
- (800) WOOD, O. M.
1936. EARLY SURVIVAL OF SOME PINE INTER-
PLANTINGS IN SOUTHERN NEW JERSEY.
Jour. Forestry 34: 873-878, illus.
- (801) 1939. RELATION OF THE ROOT SYSTEM OF A
SPROUTING STUMP IN *QUERCUS MONTANA*
WILLD. TO THAT OF AN UNDISTURBED
TREE. *Jour. Forestry* 37: 309-312, illus.

- (802) WOOD, O. M.
1939. REPRODUCTION OF SHORTLEAF PINE FOLLOWING MECHANICAL TREATMENT OF THE SEEDBED. *Jour. Forestry* 37: 813-814.
- (803) WRIGHT, E.
1945. RELATION OF MACROFUNGI AND MICRO-ORGANISMS OF SOILS TO DAMPING-OFF OF BROADLEAF SEEDLINGS. *Jour. Agr. Res.* 70 (4) : 133-141, illus.
- (804) —AND WELLS, H. R.
1948. TESTS ON THE ADAPTABILITY OF TREES AND SHRUBS TO SHELTERBELT PLANTING ON CERTAIN PHYMATOTRICHUM ROOT ROT INFESTED SOILS OF OKLAHOMA AND TEXAS. *Jour. Forestry* 46: 256-262, illus.
- (805) WYSONG, N. B.
1948. NATIONAL SHADE TREE CONFERENCE. *Amer. Nurseryman* 88 (6): 13-16, 18-19, 34.
- (806) YOUNG, W. J.
1940. SEED TREATMENTS WITH TALC AND ROOT-INDUCING SUBSTANCES. *Boyce Thompson Inst. Contrib.* 11: 207-218, illus.
- (807) YOUNG, H. C., APP, B. A., GILL, J. B., AND HOLLINGSWORTH, H. S.
1950. WHITE-FRINGED BEETLES AND HOW TO COMBAT THEM. U. S. Dept. Agr. Cir. 850, 15 pp., illus.
- (808) YOUNG, H. E.
1936. A MYCORRHIZA-FORMING FUNGUS OF PINUS. *Austral. Inst. Agr. Sci. Jour.* 2: 32-34. [Reviewed by A. B. Hatch in *Jour. Forestry* 34: 734. 1936.]
- (809) —
1940. MYCORRHIZAE AND GROWTH OF PINUS AND ARAUCARIA. THE INFLUENCE OF DIFFERENT SPECIES OF MYCORRHIZA-FORMING FUNGI ON SEEDLING GROWTH. *Austral. Inst. Agr. Sci. Jour.* 6: 21-25.
- (810) YOUNG, V.
1950. GAYLORD PINE PLANTATIONS AND FORESTRY POLICY. *South. Pulp and Paper Mfr.* 13 (3): 42.
- (811) ZAHN, C.
1945. FARMERS WITH WINGS. *Coronet* 19 (1): 131-133.

APPENDIX

SOUTHERN PINE CONE AND SEED DATA

TABLE 27.—Item of information and purposes for which most often needed, for four species of southern pine

Item and species	Mean or most common choice	Range †	Item and species	Mean or most common choice	Range ‡
<i>Unopened cones per bushel.</i> Estimating cone crops and cone requirements:			<i>Seeds per pound—Continued</i>		
Longleaf..... number.....	100	60-120	Shortleaf..... number.....	48,000	36,500-62,500
Slash..... do.....	200	100-240	<i>Weights of 100-seed samples.</i> Drawing subsamples from sacks or cans; setting up germination tests:		
Loblolly..... do.....	500	400-1,080	Longleaf, wings on..... grams.....	10.8	7.6-11.0
Shortleaf..... do.....	2,000	1,450-2,500	Longleaf, wings reduced..... do.....	9.6	6.8-10.8
<i>Full seeds per cone.</i> (Means are for good seed years; may be ½ or less in poor years.) Estimating cone requirements; checking quality of sample cones cut open before collection:			Slash..... do.....	3.1	2.8-3.5
Longleaf..... number.....	50-60	1-150+	Loblolly..... do.....	2.5	1.8-2.8
Slash..... do.....	60-70	1-100+	Shortleaf..... do.....	.9	.7-1.2
Loblolly..... do.....	40-50	1-200	<i>Widths of seeds at widest point.</i> Selecting wire mesh for drying-shed shelves, cone trays, and cone tumblers; selecting cleaning-mill screens; seed identification:		
Shortleaf..... do.....	25-35	(*)	Longleaf, wings on..... inches.....	0.45	0.30-0.60
<i>Yields of commercially cleaned seed per bushel of unopened sound cones.</i> (Means are for good seed years; may be ½ in intermediate and ¼ in poor years.) Estimating cone requirements:			Longleaf, wings reduced..... do.....	.26	.20-.35
Longleaf, wings on..... pounds.....	1.2	0.30-1.5	Slash..... do.....	.18	.10-.22
Longleaf, wings reduced..... do.....	1.0	.25-1.4	Loblolly..... do.....	.16	.12-.18
Slash..... do.....	1.0	.25-1.5	Shortleaf..... do.....	.12	.10-.14
Loblolly..... do.....	1.0	.25-1.5	<i>Lengths of seed without wings.</i> Designing germination-test equipment; seed identification:		
Shortleaf..... do.....	.8	.20-1.4	Longleaf..... inches.....	0.40	0.30-0.50
<i>Lengths of cones.</i> Gaging distances between trays in tiers (distances should at least equal maximum cone length; fixed shelves should be farther apart):			Slash..... do.....	.28	.24-.32
Longleaf..... inches.....	6.0	4.0-10.0	Loblolly..... do.....	.24	.22-.26
Slash..... do.....	3.5	2.3-6.0	Shortleaf..... do.....	.20	.18-.22
Loblolly..... do.....	3.0	1.8-6.0	<i>Meshes of square-mesh wire to pass seeds with wings.</i> Designing extractory shelves, cone trays, cone tumblers:		
Shortleaf..... do.....	1.9	1.1-2.8	Longleaf..... inches.....	½	⅜-¾
<i>Diameters of unopened cones at thickest part.</i> Selecting the wire or spacing the slats for cone trays, shelves, and tumblers, or for chutes to separate opened from unopened cones:			Slash..... do.....	½	⅜-¾
Longleaf..... inches.....	2.0	1.6-2.7	Loblolly..... do.....	½	⅜-¾
Slash..... do.....	1.6	1.3-1.8	Shortleaf..... do.....	½	⅜-¾
Loblolly..... do.....	1.2	.7-1.7	<i>Meshes of square-mesh wire to stop seeds with wings off.</i> Designing extractory shelves, cone trays, and trays for drying seed:		
Shortleaf..... do.....	.8	.5-1.1	Longleaf..... inches.....	⅝	⅜-1
<i>Space required to spread 1 bushel of unopened cones in single layer.</i> Designing cone trays; estimating drying or procuring space for cones:			Slash..... do.....	⅝	⅜-1
Longleaf..... square feet.....	8	6.4-8.8	Loblolly..... do.....	⅞	⅜-1½
Slash..... do.....	10	8.0-11.0	Shortleaf..... do.....	1	⅜-1
Loblolly..... do.....	15	12.0-16.5	<i>Upper screens in seed-cleaning mills.</i> Ordering and operating cleaning mills:		
Shortleaf..... do.....	20	16.0-22.0	Longleaf, wings on..... 64ths of 1 inch.....	32	30-32×48
<i>Seeds per pound.</i> Estimating seed requirements; gaging sizes of seed samples; calculating sowing rates:			Longleaf, wings reduced..... do.....	28	24-32×48
Longleaf, wings on..... number.....	4,200	3,800-6,000	Slash..... do.....	16	14-18
Longleaf, wings reduced..... do.....	4,700	4,200-6,700	Loblolly..... do.....	14	12-16
Slash..... do.....	14,500	13,000-16,000	Shortleaf..... do.....	10	10-12
Loblolly..... do.....	18,400	16,000-25,000	<i>Lower screens in seed-cleaning mills.</i> Ordering and operating cleaning mills:		
			Longleaf..... 64ths of 1 inch.....	16	8-16
			Slash..... do.....	8	6-10
			Loblolly..... do.....	6	6-8
			Shortleaf..... do.....	6	6

† Values shown have been derived from data obtained in many different studies, not from systematic surveys throughout the southern pine region. Deviations from the means, and occasional extremes beyond the stated ranges, must be expected.

‡ In cone and seed dimensions, most minima and maxima represent means of samples of unusually small or large cones or seed, not smallest or largest individual cones or seeds observed.

* 1 to undetermined.

† Yields from wormy cones may be only ¼ to ½ as much.

‡ Based on 100-percent pure seed, fanned to remove empty seeds to the extent feasible in commercial practice. Moisture content typically 10 to 13 or 15 percent.

§ With ordinary galvanized hardware cloth, mesh at least as close as ¾ inch is needed to support the weight of cones on wide trays or shelves.

¶ Meshes ¾-inch wide or wider will pass the smallest unopened cones of this species.

‡ Oval.

DESCRIPTIONS OF EXPERIMENTAL PLANTING AREAS

The geographic locations and chief climatic conditions of the principal experimental planting areas from which the data in this monograph have been drawn are given in table 28. Further details follow.

Bogalusa Experimental Plantations

The Coburn's Creek and Upper Coburn's Creek experimental plantations, totaling 14.5 and 7.0 acres, respectively, have been the principal source of detailed data from Bogalusa, La. They are ¼ mile apart, in section 5, township 3 south, range 13 east (Louisiana Baseline and St. Helena Merid-

ian), about 4 miles northwest of Bogalusa, on the southwest side of the Bogalusa-Franklinton Highway. The Coburn's Creek plantations were established by the Southern Forest Experiment Station in 1924-25 through 1926-27; and the Upper Coburn's Creek in 1925-26 through 1926-27. Some information has also come from 4 acres of loblolly spacing plantations established in 1922-23, about 2 miles south in section 17 of the same township. All these plantations were established and have been maintained on the lands and with the cooperation of the Great Southern Lumber Co. and its successor, the Gaylord Container Corp.

The area is within the upper Coastal Plain. Detailed soil maps of the Coburn's and Upper Coburn's Creek areas prepared in 1924 and 1925 show Myatt very fine sandy loam, Kalmia very fine sandy loam, and negligible areas of other soils on the less well-drained parts of the Coburn's Creek area, and Susquehanna and Norfolk very fine sandy loams in all the better drained parts of the Coburn's Creek area and all of the Upper Coburn's Creek area except one poorly drained corner occupied by Myatt very fine sandy loam. The outstanding characteristic of the soil on all but the poorly drained parts is the presence of a stiff sandy clay or clayey sand from 12 to as little as 4 inches below the sandier surface soil. Such soils are typical of millions of acres of cutover land, formerly in pure longleaf pine, from Alabama to Texas inclusive.

The Coburn's Creek area lies about one-third on a flat but well-drained ridge top, one-third on a broad, uniform slope of 4 to 5 percent, and one-third on a moderately to poorly drained flat next to Coburn's Creek. Terrestrial crawfish are abundant on the poorly drained flat. The Upper Coburn's Creek area straddles a low, flat-topped,

well-drained ridge, and slopes off to either side with a maximum gradient of 3 to 4 percent; one corner lies in a wet spot. The loblolly spacing plantations in section 17 lie near the foot of a long, uniform, 3-percent slope.

All three areas originally bore heavy pure stands of large longleaf pine. They were logged in 1918 to 1920, with steam skidders. Fires were common until 1920, when fire protection was begun and the areas were fenced against hogs. There have been no fires since 1920, except on one quarter-acre at Coburn's Creek, burned over annually during 1921 through 1924, as part of a firebreak. A few cattle have grazed the areas annually since planting.

When planted, the three areas were open grassland, in which *Andropogon scoparius* was the dominant species; with it were associated *A. tener* and many other grasses and broadleaved herbs, including pitcher plants on the least well-drained spots at Coburn's Creek. At planting time there were only negligible hardwood sprouts and brush. Since planting, oaks, hollies, dogwood, blackgum, and sweetgum, a little yellow-poplar, other hardwood tree species, some waxmyrtle and other brush, and dense thickets of gallberry and of blackberries have invaded most of each area.

All the experimental planting at Bogalusa was done in furrows plowed 1 week to 15 months before planting.

The Bogalusa plantations are just inside the northwestern limit of the natural range of slash pine. They are outside the ranges of pocket gophers and Texas leaf-cutting ants, and well beyond the southeastern zone of deficient spring rainfall, but are within the zones of maximum brown-spot and fusiform-rust infection. Rabbit damage was variable but often moderately severe

TABLE 28.—Location, approximate elevation, and climatic conditions of principal experimental planting areas mentioned in text 1

Item	Location			
	Bogalusa, Washington Parish, La.	J. K. Johnson Tract, Rapides Parish, La.	Harrison Experimental Forest, Harrison County, Miss.	Auburn, Lee County, Ala.
Latitude.....	30° 49' N.	31° 11' N.	30° 36' N.	32° 36' N.
Longitude.....	89° 55' W.	92° 41' W.	89° 04' W.	85° 30' W.
Elevation above sea level..... feet	130-150	160-260	155-190	680-700
Temperature:				
Mean annual..... °F	68	67	67	65
Mean January..... °F	52	51	53	50
Mean July..... °F	82	82	82	80
Frost-free period..... days	255	255	270	235
Precipitation:				
Mean annual..... inches	61	55	62	52
April through September..... do	34	27	34	24
June through August..... do	18	14	19	14
Mean relative humidity, noon, June..... percent	62	60	63	59

¹ Climatic data interpolated from maps in *Climate and Man* (733).

during the establishment of the plantations. Tip-moth injury to loblolly and shortleaf was very severe in the 1920's and early 1930's. Glaze storms have been rare and not of maximum severity, but one in December 1929 severely injured slash pine in spots.

Within a radius of 15 miles of the Coburn's Creek plantations are about 57,000 acres of commercial plantations (p. 25), on sites similar to but more varied than those just described. These have been an invaluable additional source of general and specific information.

J. K. Johnson Tract Plantations

These consist of about 750 acres, or about three-fourths of a million trees, planted by the Southern Forest Experiment Station with CCC and WPA labor on the J. K. Johnson Tract of the Palustris Experimental Forest, in the Evangeline Division of the Kisatchie National Forest, from 1934-35 through 1940-41, inclusive. The tract includes all of section 4, township 2 north, range 3 west, and some of sections 33 and 34, township 3 north, range 3 west (Louisiana Baseline and Meridian), a total of about 1,200 acres lying about 17 miles southwest of Alexandria, La., on State Highway 278.

The tract is in the upper Coastal Plain. In 1916 the Bureau of Soils mapped most of the soil in section 4 as Ruston fine sandy loam, and most of that in section 33 as Susquehanna very fine sandy loam. The soil is much more variable than these classifications suggest. Much of that in section 4 is like the better-drained soils of the Bogalusa areas, with a stiff subsoil underlying a sandier surface soil at 4 or 6 to 12 or rarely 18 inches. Some flat ridge tops, however, are of silty, poorly drained soil, excessively wet at most seasons, but dust-dry to great depths in abnormally dry summers. The only crawfish noted have been on these ridge tops. Narrower, steeper-sided ridges, mostly in section 33, are of coarse, sandy soil to a depth of at least 30 inches, and well or excessively drained. There are some outcrops of gravelly clay. There are many flats (on ridge tops) and many slopes of 1 to 5 percent, with a few short slopes of 12 to 15 percent. Despite this variation, the soils on the greater part of the tract resemble those of the better-drained parts of the Bogalusa area, and represent millions of acres of cut-over longleaf pine sites from Alabama to Texas.

The whole Johnson Tract, except for one or two small drainageways, originally supported a heavy stand of pure longleaf pine. Section 33 was logged with teams about 1906; section 4 (fig. 52) with steam skidders about 1917. Fire protection was lacking until the late 1920's and imperfect until 1933. Fire and hog protection were fairly complete from 1934, when experimental planting began, until World War II terminated planting in 1941. Fire and hog damage during the war were severe.

When planting began, the Johnson Tract was open grassland except for a few residual longleaf pines, scattered and in clumps, a little natural longleaf reproduction, and some hardwood sprouts, a few big patches of scrub oak, and hardwoods and loblolly and shortleaf pine near one drainageway. *Andropogon scoparius* predominated among the grasses, with *A. tener*, *A. elliotti*, *A. virginicus* and many other grasses and herbs intermixed. There were large patches of pure *A. tener*, however, and, on variations from the prevailing soils, distinct grass associations: mixed tall grasses in the vegetated draws; *Panicum* spp. on the flat, poorly drained ridges, and much *Muhlenbergia* spp. on the drier, steeper sand ridges. Scattered yucca plants and dwarf sumacs usually grew with the *Muhlenbergia* on these sands. The sites on which planted pines survived and grew best could usually be picked in advance of planting by their 8 to 12 or more inches of sandy loam surface soil over fairly heavy subsoil, and by the denser and taller cover of *Andropogon scoparius*. Brush invaded the Johnson Tract plantations much less rapidly than those at Bogalusa, and gallberry does not occur on the Johnson Tract.

Except in site-preparation experiments, no seedlings on the Johnson Tract were planted in plowed furrows.

The Johnson Tract is about 150 miles west of the natural range of slash pine. It is within the range of pocket gophers and Texas leaf-cutting ants, both of which interfered seriously with experimental planting until controlled. Rabbits did intermittent damage during planting. Brown-spot infection has been severe, though less so than at Bogalusa. Fusiform-rust infection was relatively light at the start of planting, but has increased. Tip-moth damage has been less severe than at Bogalusa. Glaze storms have been more frequent and more severe than at Bogalusa, with bad ones in 1943-44, 1946-47, and 1950-51. As shown by table 28, the summers are drier than at Bogalusa; summer droughts tend to be more frequent and prolonged.

Plantations on the Harrison Experimental Forest

With two or three minor exceptions detailed elsewhere, these plantations, totaling about 55 acres, were established by the Southern Forest Experiment Station in 1940-41, with WPA labor, in the eastern half of section 14, township 5 south, range 11 west (St. Stephens Baseline and Meridian), just west of State Highway 55, on the Biloxi District, DeSoto National Forest, Miss.

The area is within the upper Coastal Plain. Most of the soil in the plantations was mapped as Ruston fine sandy loam or Orangeburg fine sandy loam by the Bureau of Soils in 1924. In general it is representative of the better cutover longleaf pine sites, with 8 to perhaps 15 inches of fine sandy

FIGURE 52.—Part of J. K. Johnson Tract in 1937. Natural reproduction from the scattered long-leaf trees left uncut in 1917 has been negligible.



F-465244

loam over a friable to fairly stiff clayey sand or sandy-clay subsoil. All is nearly level to gently sloping, and generally well drained ; crawfish have not been noted. When planted, most of the area was cutover land, never cultivated, variously burned and later protected, and moderately grazed, largely open, partly brushy. The best soils had been farmed at irregular intervals, in irregular patches abandoned from 2 to 10 or more years before planting. Some of these abandoned fields retained furrows; all varied one from another in vegetative cover—ragweed, *Andropogon virginicus*, carpetgrass, *Panicum* spp., or blackberries—depending on past history. The parts not cultivated were quite uniformly in *Andropogon scoparius* and associated species typical of cutover longleaf land from Alabama to Texas. Some gallberry was present, but did not increase as rapidly as at Bogalusa during the first 10 years after planting.

None of the 1940-41 Harrison planting was in furrows. Initial survival on about one-third of the area was seriously reduced by too long storage of the planting stock.

The Harrison experimental plantations are well within the range of slash pine, but there is little natural slash pine on the site. The plantations are outside the ranges of pocket gophers and Texas leaf-cutting ants, within the same zone of adequate spring and summer rainfall as the Bogalusa plantations, and in an area of somewhat less severe brown-spot infection and tip-moth infestation and of possibly less severe fusiform-rust infection than the Bogalusa plantations. Brown-spot and rust infections on the Harrison have

nevertheless been heavy ; rust infection on slash pine planted on abandoned fields has consistently been about twice as heavy as on the same species planted on land never cultivated. Rabbits did little damage in 1940-41. Glaze storms have been a negligible hazard.

Experimental Plantations at Auburn, Ala.

The Auburn plantations were established by the former Department of Horticulture and Forestry, Alabama Polytechnic Institute, at various times from 1928 through 1941, on almost unclassifiable soils transitional between upper Coastal Plain and Piedmont, in sections 25 and 36, township 19 north, range 25 east (St. Stephens Baseline and Meridian), on the institute's experimental farm in the outskirts of Auburn, Ala. The original forest, before clearing many years ago, was mixed longleaf, shortleaf, and loblolly pines, with considerable intermingled oak and hickory. At the time of planting, the area was a miscellany of variously farmed out, eroded, and abandoned old fields and waste ground between fields. The sites are far less typical of cutover longleaf pine land and more representative of many loblolly-hardwood sites than those at Bogalusa, on the Johnson Tract, and at the Harrison. Some slopes at Auburn, although not excessive, are steeper than any of those on the other three areas. There are few, if any, poorly drained spots.

Auburn is fully 60 miles north of the natural range of slash pine (773). It is outside the ranges of pocket gophers and Texas leaf-cutting ants. Brown spot has done some damage, but has been

distinctly less severe than in the other experimental plantations described, especially those at Bogalusa. Fusiform rust is much less severe than in the Bogalusa and Harrison plantations, and apparently less severe than it has recently become in the Johnson Tract plantations; cultivation of slash pine after planting, even on old fields, has nevertheless approximately doubled infection (106). Data on tip-moth and rabbit damage are not available, except that such damage evidently has not been a major problem. Glaze storms are fairly frequent, but have not struck the experimental plantations very hard. These plantations are within the littleleaf zone, near the point of original discovery of the disease, and near areas of maximum littleleaf injury to older shortleaf and loblolly pines.

SAFETY RULES FOR THE USE OF INSECTICIDES, FUNGICIDES, BAITs, AND REPELLENTS

Most insecticides and fungicides as well as some other sprays and baits contain poisons injurious, if not deadly, to humans and livestock. Many act through the skin or lungs as well as through the digestive tract. In addition, some are flammable or explosive, or involve other hazards.

Unless a substance is known to be perfectly harmless, every care should be taken to avoid accidents arising from its use. Furthermore, prevention of serious injury or loss of life may require correct action within minutes, or even seconds, if accidents do occur.

Proper precautions against accidents require : (a) Correct information on the part of foremen and crew ; (b) thorough training and supervision of the crew; and (c) the right equipment, properly maintained.

To reduce risk to the minimum, not only the foreman but also every man in the crew must know what to do in case of accident. This knowledge enforces respect for the materials used and reduces the danger of accidents. Surgical supply-house charts telling what to do in case of poisoning and burns should be kept posted in equipment and supply buildings, together with manufacturers' warnings about and antidotes for the specific poisons used. These should be studied till memorized, and foremen and workmen who apply insecticides and the like should be drilled in the treatment for poisons and burns, and for injuries to the eye (47). These inexpensive precautions may easily prevent work stoppages, damages suits, and unnecessary suffering or even death.

Enforcing the following general rules (22, 555) should minimize accidents with poisons and other hazardous materials.

1. Plainly mark both temporary and permanent containers to show nature of contents (poisonous,

flammable, or the like) and date of purchase (some chemicals change or deteriorate with age). Keep dangerous materials tightly closed (unless their nature requires venting); out of reach of children, irresponsible persons, livestock and pets; and in an adequately ventilated storeroom, preferably locked.

2. When mixing or applying poisonous materials, take extreme care to keep them out of mouth, eyes, nose, and lungs and away from tender parts of the body. Ordinarily, wear leather or paraffined-cloth gloves (rubber or plastic gloves must be used with certain chemicals), and always wear goggles, respirator, or a combination of the two if the substance requires. If manufacturer specifies, mix substance only in open shed or outdoors.

3. Prohibit smoking during the mixing or application of flammable or explosive substances.

4. Burn or bury empty packages and bags that have contained poisons. Bury unused or discarded materials. When mixing vessels, sprayers, and the like are washed after use of the more poisonous substances (such as sodium fluosilicate), empty wash water into hole in ground, and fill in the hole. Do not burn empty arsenical containers except in open air.

5. Always wash hands and face thoroughly after mixing or applying poisonous substances. After long exposure, bathe and change clothes. Wash the clothes after each day's spraying operation.

6. Make sure that no poisonous spray material can in any way get into domestic or livestock water supplies.

7. If sulfuric acid must be diluted (as for acidifying soil to control damping-off), always pour the acid, which is the heavier liquid, into the water. Water poured into sulfuric acid splatters badly, with serious danger, especially to the eyes.

INSECTICIDES ⁴⁹

The insecticides discussed here have not been equally well proved by use in the southern pine region. Local experience, manufacturers' directions, or published reports must be expected to improve choice or dosage (particularly of the new synthetic organic multipurpose insecticides) in some instances. Whenever the threat of immediate loss from insects is not excessive, unproved treatments should be tried experimentally before being applied wholesale.

Within the five general classes which follow, insecticides are listed alphabetically.

⁴⁹ Much of the information concerning these and not credited to other sources is from *Entomo* (45, 46). Current editions of *Entomo* are convenient sources of trade names and ingredients of insecticides, and of companies supplying them.

Multipurpose Insecticides

The new synthetic organic insecticides introduced into general use during or since World War II, although sometimes called contact insecticides, seem better classed as multipurpose insecticides because numbers of them also act as stomach poisons and some as fumigants.

In general these insecticides are complex chemicals, notable for the low dosages required per acre, their effectiveness against many different insects, and their ability both to reach and to control important pests relatively unaffected by older insecticides. Some, however, are ineffective against certain common pests, or even cause them to increase (DDT does this with red spider and some aphids), apparently by killing predators or parasites of the pests while leaving the pests uninjured. The multipurpose insecticides seldom require spreaders or stickers, as these are formulated into the commercial products; also, many have inherent residual effects, particularly valuable in controlling insects that subsequently hatch in or migrate into the treated area. Many are extremely toxic to humans, and, as a general rule, precautions must be taken to keep sprays and especially oil emulsions containing these insecticides from getting on the skin, and to wear respirators when measuring, mixing, or applying the insecticides as powders or dusts.

It should also be pointed out that DDT and BHC are of variable effect and by no means uniformly successful. Their effectiveness in controlling many insects depends on proper timing. The U. S. Bureau of Entomology and Plant Quarantine, or the appropriate State plant quarantine and nursery inspection official (p. 214) should be consulted concerning timing of treatment.

Benzene hexachloride (BHC; hexachlorocyclohexane ; one trade name of a dust, "Lexone 50") . For aphids, grasshoppers (for which it excels DDT) , harvester ants, mole crickets, and white grubs, and many caterpillars and adult beetles. It contains several isomers, of which only the gamma isomer is effective insecticidally, and the gamma isomer content should, therefore, be ascertained before purchase or use. Available in wettable powders containing at least 6 to 10 percent of gamma isomer; in dusts containing 2.5 to 12.0 percent of gamma isomer. Dosages of 0.25 to 1.25 pounds of *gamma isomer* per acre (up to 20 pounds of dust per acre, depending on concentration) are effective. Promptness of kill and extent of residual effect reported variable. Harmfulness to plants, in dosages required for insects, apparently somewhat variable; reported less dangerous to operators than some other multipurpose insecticides. (28,117,330,392, 428,775,797.)

For *mole crickets*, 50 percent wettable powder containing 6 percent of gamma isomer is reported as a promising spray (368).

For *white grubs*, the North Carolina Division of Forestry and Parks has found it effective to apply one of the more concentrated wettable powders at the rate of 20 pounds per acre, when damage by grubs appears, and wash it in with the sprinkling system.

Chlordane.—For ants, aphids, grasshoppers (for which it excels DDT), mole crickets, white grubs, caterpillars in general, some leaf miners, possibly nematodes. It is a liquid in pure form, but is available in various concentrations of dusts, wettable powders, and emulsions. The dusts are applied as they come from the package. The wettable powders are sprayed in mixture with other water-wettable-powder sprays by use of conventional sprayers only, and emulsion sprays with either conventional or mist type sprayers. Usual dosages are 1 or at most 2 pounds of actual chlordane per acre. (One quart of 50-percent emulsion, or 2 pounds of 50 percent wettable powder, or 10 pounds of 10-percent dust, applied per acre, give 1 pound of actual chlordane per acre, whether diluted much or little.) It has been reported as a relatively slow killer, at least for grasshoppers, with 10 or more days' residual effect. (26,28, 154, 304, 392, 428.)

For *harvester or mound-building ants*, insert one-eighth teaspoonful of 50-percent powder in a hole in each hill (154).

For *mole crickets*, spray with 1 pound of 50 percent wettable powder per 100 gallons of water, or make up into 5-percent bait, as directed by manufacturer (26) .

For *white grubs*, apply 20 pounds of 50-percent powder per acre ($\frac{1}{2}$ pound per 1,000 square feet) as a spray, or mix with sand and work into the soil dry.

Chlorinated camphene (Toxaphene) .—Reported effective for ants, grasshoppers, mole crickets, most caterpillars, and possibly for nematodes; for grasshoppers, at least, a slow killer, with 10 or more days' desirable residual effect. Available in various concentrations of nonwetable dusts, wettable powders, and emulsions. For grasshoppers, dust or spray at convenient dilutions to give 1 $\frac{1}{2}$ to 2 $\frac{1}{2}$ pounds of actual chlorinated camphene per acre. For other pests, see manufacturers' directions. (26, 390.)

DDD (Dichloro-diphenyl-dichloroethane ; also referred to as TDE ; one trade name is Rothane).—Closely related to DDT, and useful in general in same way ; specifically reported as effective against mole crickets. Chief advantage over DDT is its lower toxicity to humans. Apply according to manufacturers' or State agricultural experiment station's directions. (368.)

DDT (Dichloro-diphenyl-trichloroethane) .—For ants, *C olaspis* beetle, crawfish, some cutworms, grasshoppers (but less effective than either chlordane or benzene hexachloride for grasshoppers) , mole crickets, pine webworms, sawflies (for

which it excels lead arsenate), some scale insects, tip moths (including Nantucket), white-fringed beetle (most effective treatment yet reported for this insect), white grubs, and miners, suckers, and borers generally. It increases injury by red spiders and is ineffective against, or actually causes increase of, some aphids.

It comes in nonwetable dusts or powders, wettable powders, ready-to-use oil-based sprays, and oil-, xylene-, or other emulsion concentrates, all of varying concentrations of actual DDT. The less concentrated dusts are applied as they come from the package; the more concentrated require dilution with inert dusts. Solutions made with the wettable powders should be applied with conventional sprayers only, not with fog sprayers or mist blowers; sprays prepared with emulsions appear applicable in almost any manlier except with fog machines. Dosages usually are reckoned in pounds of actual DDT per acre. One pound of actual DDT per acre is a common dosage for many insects feeding on aboveground parts of plants; and 10 to 50 pounds of actual DDT sprayed on or worked into the soil, for soil-inhabiting insects. For applications not calculated by acreage, thorough wetting with a 1-percent solution is frequently recommended. Most concentrations effective against insects are harmless to plants, but on some plants certain oil sprays cause injury if used after DDT. DDT in oil preparations is readily absorbed through the skins of humans and other warm-blooded animals, with possible serious injury; such absorption through the skin should be avoided, and the dust should not be inhaled. (14, 18, 21, 27, 28, 29, 36, 206, 225, 284, 304, 368. 428, 775.)

For control of *Colas pis beetle* from the ground, thorough coverage with 1-percent emulsion or suspension in water is suggested; for possible airplane spraying, 1 pound actual DDT in 1 gallon of oil per acre.

For *crayfish*, spray whole cottonseed, or coarsely ground corncobs thoroughly with 2.5-percent solution of DDT; scatter 1 1/2 bushels of cottonseed or 100 pounds of ground corncobs per acre whenever damage occurs; treatment is most effective in warm, rainy weather. A single sprayed cottonseed dropped in a burrow will kill the crayfish in it. (225.)

For *mole crickets* on small areas, add 1 to 4 pints of 25 percent DDT in emulsion concentrate to 100 gallons of water and apply to soil with sprinkling can at rate of 1 gallon of mixture to 10 square feet of soil, to give about 10 to 40 pounds of actual DDT per acre. On large areas, apply 150 pounds of 20 percent DDT dust (30 pounds of actual DDT per acre) with fertilizer, before sowing, and work into top few inches of soil; increase dose slightly if mole crickets are very numerous. Neither treatment should injure plants; each will stimulate mole crickets to excessive activity for a day (a sign the insecticide is working) but should render them harmless in 2 to 3 days, and also control ants and cutworms. (368.)

For *pine webworm*, spray with 1-percent emulsion.

For *saw fly larvae*, spray thoroughly with 0.5- to 1.0-percent DDT emulsion or suspension in water, or apply at the rate of 0.5 to 1.0 pound of actual DDT per acre (14, 383).

For *scale insects*. The effectiveness of DDT on scale insects attacking southern pines appears not to have been reported, but its 2 to 3 weeks' residual effect makes it better than oils or nicotine sulfate for some scale insects, including pine-leaf scale on ornamental pines. Thorough application of 1.0-percent solution (16 pounds of 50 percent wettable powder in 100 gallons of water) is reported effective against European elm scale, a species notoriously difficult to control. (18, 284.)

For *Nantucket tip moth* or other shoot moths in plantations, spray thoroughly with 0.5- to 1.0-percent solution of DDT in water early in each of first two flights of the year (36), or, for more certain control, when moths of each flight first appear and again 10 days later (29). Airplane application of 0.5 to 1.0 pound of DDT per acre of plantation has also been proposed; for maximum effectiveness it would have to be made early in flight of adults. DDT appears highly successful against tip moths generally (14), and spraying or dipping nursery stock with 1.0-percent DDT emulsion before shipment should be as effective as and cheaper than the white-oil-emulsion or nicotine-oleate dips.

For *white-fringed beetle*, work 10 to 50 pounds per acre of actual DDT into the top few inches of soil, if possible in successive applications of 0.5 to 1.0 pound every 2 weeks rather than all at once. Some effects of treatment persist 2 to 5 years; 50 pounds per acre should give virtually complete control for 2 years (27). These applications have been reported noninjurious to plants; 1/3 to 1 pound of actual DDT per acre of foliage has been reported to kill 90 percent of adult beetles, with great reduction of later populations of larvae.

Although not explicitly reported for southern conditions, control of *white grubs* by working about 20 pounds of actual DDT per acre (5 pounds of 10-percent powder per 1,000 square feet, or 200 pounds per acre) is suggested (206).

HETP or HEPT (Hexaethyl tetraphosphate; trade names: Hexide, Hexate, Killlex, Vaportone).—Insecticides containing this basic chemical are reported effective against aphids, red spider, and many other insects, and against young scale insects when mixed with DDT. Erratic, toxic to warm-blooded animals and dangerous to operator (requiring mask and rubber gloves), and corrosive to galvanized equipment. It contains about 15 percent of TEPP as the principal active ingredient; TEPP content must be stated on label. Available in water-soluble and emulsifiable forms. Apply at rate of 0.5 pint per 100 gallons of water, or according to manufacturer's directions. (19, 284, 304.)

Parathion (trade names: E-005, Parathion 3422, Thiophos, Thiophos 3422, 3422).—Particu-

larly effective on aphids and red spider; also used on grasshoppers, leaf miners, soft scales, and some beetles, leafhoppers, moths, and many other insects. It smells like garlic or onions. It is available in prepared dusts, and wettable powders; 15 percent and 25 percent wettable powders are usually sprayed at the rate of 1 pound per 100 gallons of water (minimum, 2 ounces; maximum, 2 pounds), and 2 or 4 pounds of 25 percent wettable powder may be combined with 100 pounds of inert dust to make 0.5- to 1.0-percent dust. Reported relatively or wholly noninjurious to plants including *unless used in connection with bordeaux* (an important point in southern pine nurseries); safest not to use in connection with any other spray material. Residual effect for 5 to 15 or more days, killing delayed arrivals and late-hatching eggs. *Deadly to higher animals and humans*; use fullest precautions, including respirator, in measuring, mixing, and applying. (26,29,31,369,406.)

TEPP.—Contains 40 percent tetraethyl pyrophosphate, HETP, as the principal active ingredient. Particularly effective for aphids and red spider. May injure plants treated with copper in any form (as bordeaux). Poisonous; use with extreme precaution. For application, follow manufacturers directions.

Fumigants

In seed, nursery, and planting practice in the southern pine region, fumigant insecticides have been used primarily to control soil-inhabiting insects; less frequently, to control nematodes.

Calcium cyanide (one trade name, Cyanogas).—See hydrogen cyanide.

Carbon disulfide (also referred to as carbon bisulfide; known locally as "high life").—For harvester ants, various mound-building ants, Prionid larvae, Texas leaf-cutting ants, and white grubs in nurseries, and Texas leaf-cutting ants in plantations.

Carbon disulfide is a volatile liquid and very flammable; its vapor in mixture with air is highly explosive. Safe handling requires transportation in tightly closed containers kept as cool as possible (not exposed to sun), no smoking, and strict avoidance of open flames or electric sparks. Effectiveness against soil insects results in part from weight of vapor, two and one-half times that of air.

For controlling *Prionid larvae* and *white grubs* in nurseries after damage appears, pour or inject 1.2 cubic centimeters of carbon disulfide per hole in 1/2-inch holes punched in the soil to depth of 3 to 4 inches, 6 inches center to center (equivalent to 1 pint per 100 square feet), when soil is moist but not wet (maximum moisture content about 15 percent), at a temperature (top 6 inches) of at least 78° F., and loose and friable; plug each hole tightly with soil immediately after injection. To

avoid injury to seedlings, make holes between drills, do not water within one hour after injection, and do not inject immediately before or after rain. Straight carbon disulfide applied in this way has proved more manageable and less injurious than carbon disulfide emulsion flooded on the bed surface. (359, 360.)

For *harvester* or *mound-building ants* in nursery beds, apply as above, or punch holes well into the mounds or burrows and pour in up to an ounce or two of carbon disulfide per mound, sealing the holes immediately (255).

For control of *Texas leaf-cutting ants* see page 232.

Chloropicrin (Chlor-picrin, Larvacide, and other trade names).—Chloropicrin is a heavy, colorless (or slightly yellowish) liquid, almost insoluble in water but soluble in alcohol, gasoline, and other organics, and readily volatilizing into "tear gas" heavier than air. It is effective against cutworms, white grubs, nematodes, and soil fungi. Because it is extremely irritating it is best measured out in open air, and injected with hand or power applicators (440).

Requirements for treatment are quite exacting. It must be applied 5 to 24 (usually 7 to 10) days before crop is sown; soil must be permeable but not too loose, moderately moist, and moderately warm (60° to 85° F. is about optimum); application of 1 to 3 cubic centimeters per hole in holes 3 inches deep (5 to 6 inches on lighter soils) and 8 to 10 inches center to center (rates per acre quoted: 33 to 41 gallons, or 230 to a maximum of 740 pounds); holes must be closed immediately after injection, and soil sealed with water at rate of about 1 quart per square foot of bed surface (manufacturers specifications; unpublished data). Even when so applied, and with sowing deferred till 3 weeks after treatment, it may cause some injury to southern pine seedlings.

Cyanamid (trade name for mixture of calcium cyanamide, hydrated lime, carbon, calcium carbonate, and calcium sulfate).—For *nematodes*, recommended at rate of 1 ton per acre, applied dry, well worked in and washed in with water 6 to 8 weeks before sowing, and recultivated repeatedly, between application and sowing; even with these precautions sometimes injurious to crop plants and, therefore, preferably applied before soiling crop (055). Appears not to have been tried on southern pine seedbeds.

Ethylene dichloride.—*Ethylene dichloride* injected into soil like carbon disulfide for white grubs, but at rate of 1 gallon per 100 square feet, may control white grubs effectively after they appear in the nursery (360).

Ethylene dibromide (trade names: Dowfume W40, Dow W-40, Garden Dowfume, Iscobrome D).—For white grubs and nematodes. A liquid, sometimes diluted with naphtha. It is applied 1 to 3 weeks before sowing as specified by the manufacturer (206, 440). Dow W-40 applied in the

manner and at the rate described for chloropicrin appears to have been effective against nematodes in southern pine seedbeds.

Hydrogen cyanide.—*Hydrogen cyanide*, or hydrocyanic acid gas, because of its extreme toxicity and the difficulty of applying it under nursery or plantation conditions, has apparently not been used directly to control southern pine pests. It is liberated, however, from calcium cyanide upon exposure to moist air, and calcium cyanide (obtainable in dust, granule, or flake form under the commercial name of Cyanogas) has effectively controlled *harvester* or *mound-building ants* when sealed into 1/2-inch by 12-inch holes punched into their nests.

Methyl bromide.—*Methyl bromide* (trade names : Dowfume G and Iscobrome) has proved equal or superior to carbon disulfide for control of Texas leaf-cutting ants in plantations (357, 358) and seems a promising alternative to carbon disulfide for control of Prionid larvae, white grubs, and various ants in nursery beds, especially, as it may be obtained in 1-pound sealed units, with applicators. For *white grubs* or *ants*, apply like carbon disulfide. It is described as controlling nematodes, as having relatively low toxicity to growing plants, and as being applicable as a soil treatment as little as a week before sowing. For control of *Texas leaf-cutting ants*, see page 232.

Sodium cyanide-ammonium sulfate treatment for nematodes.—Well in advance of sowing, apply 600 pounds of sodium cyanide per acre; irrigate or wash in thoroughly; *immediately* (at the very latest, the same day) apply 900 pounds of ammonium sulfate per acre and wash into the soil even more thoroughly. The whole effectiveness of the treatment rests upon applying ammonium sulfate immediately after the sodium cyanide ; there must not be delay, nor must the two substances be mixed before application, because what kills the nematodes is the chemical reaction of the two substances in the soil. For absolute eradication, double the quantities stated. (055.) The treatment is expensive but may be well justified for controlling localized outbreaks before they spread.

Contact Insecticides

Contact insecticides are used to control pests with sucking mouth-parts (aphids, red spider, scale insects, and the like) which are not affected by stomach poisons. Thorough coverage at the right stage in the insect's development is essential to success, as is avoidance of solutions injurious to the pines. If used in combination with other substances, they should first be tested on small plots, as some oils used as contact sprays cannot be applied after DDT or sulfur, without injuring the foliage of some plants (21).

See also multipurpose insecticides, but note that DDT cannot be used to control red spider and some aphids because it increases injury.

Bordeaux mixture.—A fungicide (see p. 208) rather than insecticide, but frequently recommended for red spider. Apply in ordinary strength, but heavily enough and under enough pressure to insure thorough coverage.

Cube ("koobay") and derris powders.—Organic insecticides, useful alone or with wettable sulfur for controlling red spider. Apply according to manufacturer's directions.

Lime-sulfur.—Suggested at rate of 1 gallon of liquid commercial concentrate (density about 30° B.) to 100 gallons of water to control *red spider* (255). Lime-sulfur also may be mixed from prepared powders (commercial dry lime-sulfur, 2 pounds ; Santomerse S, 1/2 pint ; water, 50 gallons) or in other ways (as hydrated lime, 5 pounds; dusting sulfur, 4.6 pounds ; ortho-spreader, 0.5 pounds ; water, 50 gallons). Occasionally used for pine-needle scale (29) but the stronger solutions (1 part to 8 or 9 of water) are frequently recommended for dormant sprays for various scale insects on deciduous trees. It has been used against many sucking insects, particularly scale insects, but probably cannot be used on pines without seriously burning the foliage (232, 289).

Lubricating oil emulsion (with nicotine sulfate).—For scale insects.

Lubricating oil _____	1 gallon.
Soap (kind unspecified; divide finely if not liquid) _____	7 1/4 pounds.
Nicotine sulfate _____	1/2 pound (1/2 pint if liquid).
Water _____	50 gallons.

Emulsify thoroughly by pumping back on itself. Apply freshly mixed to scale insects immediately they appear.

Miscible oil emulsions (White oil emulsions ; one trade name, Volck).—For scale insects and for tip moths in the egg or early larval stages.

The miscible oils are much more convenient contact insecticides than lubricating oil, and are less likely to burn the foliage. They are self-emulsifying with water but some of them separate in the container and require stirring before mixing with water. They may be used at the rate of 1 or 2 parts to 100 parts of water (for small lots, 1.28 fluid ounces per gallon of water), alone or with nicotine sulfate (usually 1 pint of nicotine sulfate to 100 gallons of water) , or with nicotine sulfate plus soap, or according to manufacturer's directions. The brands supplied in thick or pastelike condition should be mixed thoroughly with a small portion of the total water required, before the final mixture is attempted. (93.)

As a dip for tops of seedlings to kill *tip-moth eggs* and *small larvae* on nursery stock ;

Miscible oil or miscible oil emulsion _____	1 part.
Water _____	100 parts.

One gallon of the mixture treats up to 1,000 seedlings (93).

As spray for scale insects, applied at first appearance of scales :

Miscible oil or miscible oil emulsion.	1 gallon.
Soap (dissolved completely in water).	7¼ pounds.
Nicotine sulfate	½ pound (or ½ pint).
Water	50 gallons.

Nicotine dust.—For aphids (032). Apply according to manufacturer's directions.

Nicotine oleate.—A dip for seedling tops to kill *tip-moth eggs* and *small larvae* on nursery stock.

Make stock solution by thoroughly mixing 10 parts by volume of 40 percent *free* nicotine solution (not nicotine sulfate) with 7 parts of commercial oleic acid to form a soft soap. For dipping mixture, dilute 1 part of this stock solution with 46 parts of water, thoroughly mixing stock solution with small portion of water before mixing with whole. One gallon of 40 percent nicotine plus 0.7 gallon of oleic acid makes a final mixture for about 40,000 trees at most (93).

Nicotine sulfate.—For aphids, red spider, and scale insects. The usual commercial form, sold under a great variety of trade names, is a 40-percent solution. Dilute at rate of 1 part to 800 or 1,000 parts of water (1 pint to 100 gallons of water, or 1¼ to 2½ teaspoonfuls to a gallon) ; 1 part to 500 parts of soapy water for scale insects. Two ounces to 3 pounds of soap per 100 gallons of water greatly increases the effectiveness of the nicotine sulfate. (232, 289.) (See also lubricating and miscible oil emulsions.)

Rotenone.—The principal toxic constituent of cube and derris powders.

Sulfur.—Available as a fine powder for dusting, alone or with equal quantities of hydrated lime, or as a special, *wettable sulfur powder* for application alone or with wettable cube or wettable derris powder, for red spider. One recommended combination is 4 pounds wettable sulfur, 4 pounds wettable cube (or derris) powder, and 100 gallons water, applied with power sprayer (24, 255).

Stomach Poisons Used Mostly as Foliage Sprays

Arsenate of lead or lead arsenate.—For sawfly larvae, *Tetralopha* larvae, adult *Colaspis* beetles, adult May beetles, and miscellaneous chewing beetles, most caterpillars, and leaf-chewing insects generally (relatively ineffective for cutworms and grasshoppers). (See also multipurpose insecticides.)

Use *acid* lead arsenate (PbHAsO₄), not basic. Since forest insects seem to require heavier dosages than agricultural crop insects, mix in the proportions of 2 pounds of powder or 3 pounds of paste

to 50 gallons of water (for small lots, 6 teaspoonfuls per gallon). Add hydrated lime, in weight equal to that of the lead arsenate, if necessary to prevent burning foliage. A spreader or sticker usually improves results. (246, 289, 197, 679.)

Calcium arsenate.—Calcium arsenate seems not to have been used to control insects on the foliage of southern pines. Before it is applied wholesale, it should be tried on test plots, to make sure it does not burn the foliage.

One ounce of calcium arsenate in each ant nest has been recommended for harvester ants in nurseries, if carbon disulfide cannot be used.

Stomach Poisons Applied as Baits

Poisoned baits may be the only recourse if cutworm or mole cricket outbreaks occur after nursery beds have been made, or when cutworms attack seedlings after secondary needles have appeared. For early season control, see multipurpose insecticides. Grasshopper baits are useful when the newer insecticides are unavailable.

For cutworms 5°—To be effective, cutworm bait must be dry enough to crumble readily after having been squeezed in the hand, but not too dry to cling together in flakes when scattered. It should be scattered at the rate of 15 to 20 or even 30 pounds of *dry* ingredients per acre. It must be used early in the outbreak, before the cutworms complete their damage and stop feeding, and must be scattered after or shortly before sundown, because cutworms are night feeders.

In the formulas given, shorts, rice bran, or alfalfa meal may be substituted for wheat bran, and cottonseed meal may be substituted for half the bran (205). The poisons mentioned appear to be interchangeable ; calcium arsenate and lead arsenate, however, are relatively ineffective against cutworms (205, 422) and should not be substituted in the formulas; white arsenic (arsenic trioxide) should be used only in very finely powdered form, as ordinary granular white arsenic is unsatisfactory (205).

For early season controls, see DDT and benzene hexachloride.

FORMULA 1 (763)

Ingredient	Large lot	Small lot
Wheat bran	50 pounds	1 peck.
Paris green or white arsenic.	2 pounds	¼ pound.
Water	1 gallon or more	2 to 4 quarts.

Sodium fluosilicate (Na₂SiF₆) is recommended as a replacement for sodium arsenite and arsenic trioxide in cutworm and grasshopper baits (46), and has replaced them in Government baiting programs. See manufacturers' directions or consult the U. S. Bureau of Entomology and Plant Quarantine for latest dosages.

Mix dry ingredients thoroughly ; add water, stirring vigorously until uniformly of right consistency. Works better if allowed to stand for several hours before being scattered.

In the large lot, 25 pounds of hardwood sawdust (pine sawdust seems to repel cutworms) may be substituted for 25 pounds of the wheat bran, if 2 quarts of molasses is added by stirring it into water before adding liquid to dry ingredients.

FORMULA 2 (422)

Ingredient	Large lot	Small lot
Bran.....	100 pounds....	1 pound.
Sodium fluosilicate or paris green.	4 pounds.....	1 heaping teaspoonful.
Water.....	8 to 12 gallons.	½ pint.

Mix as in formula 1.

*For grasshoppers.*⁵⁰—

FORMULA 1 (554)

Mill-run bran, mixed feed, or shorts.	25 pounds.
Sawdust (3 times <i>bulk</i> of bran) approximately.	3.5 bushels.
Liquid sodium arsenite (32 percent arsenious oxide).	0.5 gallon.
Water	10 to 12 gallons.

The bran component may be replaced with another bushel of sawdust (total 4.5 bu.) if 1.5 gallons of molasses (low grade cane or blackstrap) is added.

FORMULA 2 (255)

Bran	20 pounds.
Paris green (preferred) or white arsenic.	1 pound.
Sirup	2 quarts.
Lemons.....	3.
Water.....	3½ gallons.

Mix dry ingredients, then stir into them the mixture of water, sirup, and squeeze and finely chopped lemons.

White arsenic and sodium arsenite (the so-called 4-pound commercial grade containing 4 pounds, or 32 percent, of arsenious oxide to the gallon) are about equally effective killing agents in grasshopper baits, but lead arsenate is not. Any sawdust may be used; the finer, cleaner, and older it is, the better. Any addition of bran or of dried, ground citrus pulp improves sawdust, and such citrus pulp mixed with unground cottonseed hulls is a good carrier (762). Scatter grasshopper bait at rate of 10 to 15 pounds per acre, *wet* weight, at dawn or shortly thereafter, as grasshoppers feed in daytime only.

For other controls, see chlordane, chlorinated camphene (Toxaphene), and benzene hexachloride.

For mole crickets (799).—

Wheat bran (dry).....	100 pounds.
Sodium fluosilicate.....	8 pounds.
Water	3 to 5 gallons.

Moisten just enough to make loose-textured ball when squeezed, or crumbly mash when scooped without pressure. Since moist bran molds, mix only enough bait for one application. (Quantity given is enough for 5 acres.) Corn meal, rice flour, oatmeal, or wheat flour work less well than bran, but may be substituted if necessary. Sodium fluosilicate is the only poison which has been found effective in bait against the southern mole cricket. Scatter bait evenly; if possible, with a few flakes on every square inch. Scatter at sundown or just before (mole crickets are night feeders), when soil is moist. As sodium fluosilicate injures tender vegetation, the bait should not touch newly germinated seedlings. Treatment usually must be repeated a second, and sometimes a third or even a fourth time, at 10-day intervals.

For other controls see benzene hexachloride, chlordane, chlorinated camphene (Toxaphene, DM), and DDT.

FUNGICIDES 51

Timely application is vital to success with fungicides, and frequently involves anticipation of fungus outbreaks and treatment before infection takes place. In contrast to insecticides, which often kill insects if applied promptly after their appearance, fungicides function principally by coating the plant with chemicals which kill the fungi when they first lodge on the surface, or at least keep them from invading the plant tissues. Once fungi are inside the plant, fungicides ordinarily cannot control them. (336, 440.)

The spreaders and adhesives ("stickers") suggested for the following fungicides are either used regularly with them on southern pines or are commonly recommended for use with them on other plants. For more details, see p. 211.

Acetic acid, usually the commercial 80-percent concentration, is applied to seedbeds to control damping-off, either immediately after sowing or, preferably, 5 to 6 days before, at the rate of ¼ to ½ fluid ounce per 1½ to 2 pints of water per square foot (302). Although it has been little used on southern pines, it is reported to be less injurious than other acidifying substances, and deserves further trial where acidification is needed.

Bordeaux mixture (copper sulfate-lime mixture; blue stone-lime mixture), is used in the nursery for top damping-off, Thelephora, needle casts, brown spot on longleaf pine and other species, and southern fusiform rust on slash and loblolly (but see "Fermate" and "Zerlate"). Occasionally it is used for brown spot on longleaf in plantations.

⁵⁰The information on these, unless specifically credited to other sources, has been derived largely from three publications (45, 223, 440), and from unpublished data of the Bureau of Plant Industry, Soils, and Agricultural Engineering, Region 8 of the U. S. Forest Service, and the Southern Forest Experiment Station.

Bordeaux mixture in different concentrations can be made up from commercial powders or pastes ; more varied concentrations of usually better quality can be prepared at home. Final mixtures should be applied immediately after preparation, as they are unstable and rapidly lose effectiveness.

Satisfactory home mixtures may be made either : (a) By combining previously prepared stock solutions of lime and of copper sulfate ; or (b) by mixing high-grade copper sulfate and lime in a power sprayer equipped with an agitator, without first preparing stock solutions. Stock solutions may be stored for considerable periods and both copper sulfate and lime may be used in different forms and grades ; mechanical agitation is not essential, and small quantities of the final mixture may be prepared at any time ; but the method requires more labor and containers to handle the materials.

In either method, any desired strength may be prepared by altering the quantities of copper sulfate and lime. By substituting zinc sulfate for copper sulfate, zinc sulfate-lime solution may be prepared.

A. Stock solutions.—*Make* stock solution of copper sulfate by stirring and completely dissolving copper sulfate crystals, ground or unground, in water, at the rate of 1 pound of copper sulfate to 1 gallon of water. (This solution must be prepared and stored in earthenware, glass, or wood.) Un-ground crystals are most easily dissolved by weighing them out into a permeable cloth bag and suspending the bag with its lower half in the *top* of the water in the barrel ; placing crystals in the *bottom* of the barrel slows the process greatly.

Make stock solution of lime by slaking and dissolving 1 pound of quicklime or dissolving 1 1/2 pounds of hydrated lime per 1 gallon of water. If quicklime is used, add water slowly until the lime is thoroughly slaked, then add the rest and stir thoroughly. Hydrated lime must be of a quality and fineness to dissolve well, preferably that sold specifically for preparation of fungicides, or the "chemical" grade containing more than 70 percent calcium oxide and less than 2 percent magnesium oxide, and ground to pass a 300-mesh sieve. Hydrated lime dissolves more easily in cold water than in hot, and in soft water than in hard. Magnesium as an impurity in the lime decreases its solubility.

To prepare 4-4-50 bordeaux mixture, combine stock solutions and water in the proportion of 4 gallons of copper sulfate solution, 4 gallons of lime solution, and 42 gallons of water. For a 2 1/2-3-50 mixture, combine in the proportion of 2 1/2, 3, and 44 1/2 gallons, respectively.

Stir each stock solution well before measuring out the quantity needed for the mixture. *Do not mix the stock solutions directly.* Instead, dilute the measured quantity of lime stock solution with about three-fourths of the extra water required,

and dilute the measured copper sulfate stock solution with the remaining one-fourth of the extra water, stirring each solution while diluting. Then, stirring the diluted lime solution, pour the diluted copper sulfate solution into it. Add spreader or sticker after this final mixing has been completed. Apply immediately.

B. Mixing in sprayer.—*Use* only powdered or "snow" forms of copper sulfate, and only fresh supplies of hydrated lime, finely ground, of the special fungicidal or "chemical" grade.

To mix 100 gallons of 4-4-50 bordeaux in the sprayer tank, make a fluid paste of 12 pounds of hydrated lime and a little water. Pour 25 gallons of water into the sprayer and start the agitator. Place 8 pounds of powdered copper sulfate crystals on tank-inlet screen, and wash it into the tank with about 50 gallons of water, keeping the agitator running. Then pour the lime paste through the screen into the tank, still agitating, and wash the last of the paste through with enough water to bring the total used to 100 gallons. Still agitating, add the spreader or sticker desired. Apply immediately.

The bordeaux mixture commonly used is 4-4-50 (also called 8-8-100)—4 pounds of copper sulfate and 4 pounds of lime to 50 gallons of water, but 2 1/2-3-50 or 2-4-50 usually controls brown spot and is more economical. Bordeaux is naturally highly adhesive, but whale-oil, fish-oil, or resin-fish-oil soap (2 pounds per 50 gallons), or Santomerse S (3/8 to 1/2 pint per 50 gallons) is usually added as a spreader or sticker; raw linseed oil (5 quarts per 50 gallons) is used for particularly long-lasting effect. Direct injury by bordeaux to conifers is practically unknown, and while there has been speculation about possible bad effects from accumulation of copper in the soil through long-continued use, such injury has not been proved in southern pine nurseries. Bordeaux mixture is corrosive to metals and must be thoroughly washed from spray equipment after use. (302, 336, 652.)

For *top damping-off* of southern pine nursery seedlings, spray with 1-4-50 bordeaux as soon as trouble is identified with moderate certainty. From schedules developed for brown spot (652), a rate of 1 gallon per 100 to 250 square feet of seedbed is suggested.

It is better to try the treatment only on small areas on first suspicion of top damping-off, or spray all but a few small check plots saved for comparison, than to delay spraying until a pathologist positively identifies the disease.

For *southern fusiform rust* on slash, loblolly, and occasionally on longleaf pine, if Fermate or Zerlate is unavailable, spray with 4-4-50 bordeaux (plus 1/2 pint of Santomerse S per 50 gallons of mixture) at about 5 gallons per 1,000 square feet of actual nursery bed. This equals about 220 gallons per acre, *net*, of beds, or 145 gallons per acre

of 4-foot beds and 2-foot paths, per spraying. Use enough pressure (preferably 275 to 325 pounds per square inch) to insure good coverage. The first treatment must be applied as soon as infectious conditions develop, even if it must be sprayed on burlap or straw mulch. If sowing is before March 15, apply first spray one week after the buds on oaks nearby have burst, at the latest by the time the oak leaves are no larger than one-half their mature size. Once started, spraying should continue weekly until the middle of June—ordinarily about 10 times per season. If wet weather upsets schedule, miss no opportunity to apply a spray any time it will dry on the foliage.

For *brown spot* on longleaf pine or other nursery stock, spray with 4-1-50, 2½-3-50, or 2-4-50 bordeaux, as local tests may indicate, with ¾ to ½ pint Santomerse S per 50 gallons, at rate of about 4 to 5 gallons per 1,000 square feet (net) of seedbed, at perhaps 125 to 300 pounds pressure. In nurseries in which brown spot is likely to be serious, spray first in June or late May, or when secondary needles first develop, even if no infection is visible; in any nursery, spray without fail when scattered brown-spot lesions appear. Repeat at intervals of 4 to 6 weeks or whenever abundant new foliage develops, and especially if infection increases; 4 to 7 sprayings are usually sufficient, ending in September or October. Rainy seasons or recurrent infections necessitate more frequent spraying than dry seasons or evident control. Apply a final spray at same rate, but preferably with raw linseed oil as a sticker, a few days before lifting. (652.)

For *brown spot* on longleaf pine in plantations, spray with 4-4-50 bordeaux plus suitable sticker, sufficiently to coat foliage, in May and November of two consecutive years—either the first and second years in the plantation, or the first and second after December infection of the foliage exceeds 12 to 15 percent. Amount of mixture required per acre will vary greatly with spacing, survival percent, and size of pines; pines more than 18 to 30 inches high need not be sprayed unless conspicuously infected. (652.)

For *needle cast* in nursery or plantation, spray with double strength (8-8-50) bordeaux, at 3- to 4-week intervals, from time needles are half grown (or when infection becomes evident) until needles are full grown. Spray sufficiently to wet foliage.

For *Thelephora*, 4-6-50 bordeaux is recommended. Spray when fungus appears. Apply enough to wet the fruiting bodies.

Ceresan is one of the organic mercury fungicides applied as a dust to seed before sowing, as a protection against both seed-borne and soil-borne organisms. It contains, as the active ingredient, 5 percent of ethyl mercury phosphate. There is little information concerning its effectiveness with southern pines, but, applied at rates of ½ to 2 ounces per bushel or 2 to 8 ounces per 100 ½ pounds of dry seed, or according to manufacturers' specifications, it may reduce pre-emergence damping-

off. It is highly toxic to humans, and must be handled with care.

Chloropicrin is coming into increasing use to control soil fungi. Found effective against nematode-complicated "root rot" in one U. S. Forest Service nursery (426).

Copper oxide (cuprous oxide), applied as a dust to seed before sowing, at the rate of 1 ounce per pound of dry seed, or according to manufacturers' directions, may reduce pre-emergence damping-off, but may cause chemical injury to the seedlings if sowing is in very hot weather.

Ethylene dibromide. Not considered a reliable fungicide, but found effective in one U. S. Forest Service nursery against nematode-complicated "root rot"; see page 205 and also chloropicrin.

Fermate ("Karbam black"), ferric dimethyl-dithiocarbamate, a black, wettable powder, is apparently a good general fungicide; unusually effective for rust, for which it is superior to bordeaux. It is compatible with most insecticides and fungicides, including summer oils and lead arsenate, but not with those containing copper, mercury, or lime in any form. (805.)

For *southern fusiform rust* on slash, loblolly, and longleaf pines, apply 2 pounds of Fermate and 1 pint of Santomerse S in 100 gallons of water at the rate and schedule specified for bordeaux for this disease. To mix, make a thin paste of Fermate and water, adding water a little at a time, together with a few drops of Santomerse S to speed up mixing; then pour paste and rest of water and Santomerse S into spray tank and complete mixing there. The process is easier than preparing bordeaux.

Formaldchyde ("formalin") is applied to seedbeds and sometimes to germination-test sand flats before sowing to control damping-off. The strongest commercial solution available, usually about 40 percent, is diluted with water and applied at a rate to give ¼, ⅓, and in extreme cases ⅔ fluid ounce of the 40-percent solution plus about 2 pints of water (or somewhat less if the soil is very wet) per square foot of bed; this dosage is followed immediately by heavy watering. The beds must be aired for 4 days to 3 weeks before sowing; the lighter the soil, the lower the humus content, and the lower the temperature, the longer the period of airing required. Covering beds with paper or burlap for 3 to 5 days between treatment and airing is not necessary. The soil must not be turned over or stirred deeply between treatment and sowing—even "freshening" of the surface by raking should be kept to a minimum—and no soil covering except formaldehyde-treated soil or clean quartz sand should be applied over the seed. This treatment is expensive, but generally effective; with proper airing it leaves no residue to injure germinating seeds, and is safe to use on any soil, regardless of pH concentration or past treatments

For sand-flat germination tests, saturate the sand in the flats with 40-percent formaldehyde solution diluted at the rate of $\frac{1}{2}$ fluid ounce to 2 pints of water, in time to permit thorough airing before seeds are set.

Lime-sulfur is used less generally than bordeaux mixture for brown spot on longleaf seedlings because it is incompatible with many other sprays and may also injure the plants in hot weather. It may be substituted for bordeaux, if the latter is unavailable, at the rate specified for bordeaux 44-50, and in the dosage noted on page 206.

Methyl bromide, applied to seedbeds, in dosages like those recommended on p. 206, or, before sowing, in higher dosages as recommended by manufacturers, may effectively control damping-off and other soil-borne diseases.

Semesan is a hydroxi-mercuri-chlorophenol dust, applied dry or in water solution to seed, before sowing, to control seed-borne diseases and damping-off. It is possibly useful in this way to control pre-emergence damping-off of southern pines. It is occasionally sprayed on nursery seedlings to control top damping-off, including sand splash of longleaf pine. Highly toxic to humans; handle with utmost precaution. For top damping-off in general, apply in water according to manufacturers directions, at rate of 1 gallon of solution per 100 square feet. For sand splash of longleaf, apply $\frac{1}{10}$ ounce of Semesan per 1 pint of water per square foot of seedbed on, and 1 to $1\frac{1}{2}$ feet around, all patches obviously attacked. In either case, treat only in late afternoon or on cloudy days with no likelihood of clearing, as midday treatment on sunny days is likely to injure the plants.

Sulfur is available as a dust (in this form it should pass a 325-mesh screen), and in "modified" forms—paste or wettable powders (Colloidal sulfur, Kolofog, Magnetic 70, Micronized, Micro spray, Mike, Mulloid, and the like), many of which are adapted to preparation of lime-sulfur. Sulfur in any form is incompatible with many oil sprays. It has been little used for diseases of southern pines, but colloidal sulfur is easy to mix and apply according to manufacturers' directions, and has given good control of brown spot on longleaf pine.

Zerlate (Methosan, Karbam white) is zinc dimethyldithiocarbamate, a white, wettable powder readily suspended in water. Like Fermate, it is apparently a good general fungicide, and superior to bordeaux for rusts. It is used at a rate of $1\frac{1}{2}$ to 2 pounds per 100 gallons of water. For southern fusiform rust in nursery seedbeds, prepare like Fermate and apply at rate and according to schedule given for bordeaux. (805.)

Zinc sulfate-lime is identical with bordeaux mixture except that zinc sulfate is substituted in equal quantity for copper sulfate for the particular strength or proportion of mixture desired. It may be used when for any reason copper must be avoided or when copper sulfate is unavailable.

Prepare like homemade bordeaux mixture, except that the zinc sulfate may be dissolved in water without using the suspended bag required for copper sulfate; apply like bordeaux mixture. Has proved reasonably effective for brown spot on longleaf pine.

SPREADERS AND STICKERS 52

Directions for spraying southern pines often call for a spreader or sticker without specifying what kind, or even distinguishing between the two. Choice of the correct spreader or sticker frequently is more important than such vague directions imply. Omitting one or the other may result in incomplete or too brief coverage by either insecticides or fungicides. Choosing the wrong spreader or sticker may nullify the chemical effect of the spray.

Spreaders are necessary with many contact insecticides, and stickers with some stomach poisons and fungicides. In general, spreaders—substances that promote wetting—are not good stickers; they reduce the original deposit when applied, and reduce its later durability. They are advantageous with contact insecticides primarily, because such insecticides depend for effectiveness upon wetting the insects, not upon adhering to the leaves. Most soaps are good spreaders but poor stickers, and particularly poor with arsenicals. Many soaps and other spreaders are useful in emulsifying oils, and most soaps and most alkaline spreaders increase the effectiveness of nicotine sulfate for aphids, red spider, and scale insects, by reacting chemically with the nicotine sulfate as well as by improving wetting. Petroleum oils differ from soaps in being good stickers as well as spreaders, and certain animal oils (including fish oil) and vegetable oils are excellent adhesives. Calcium caseinate is chiefly a sticker, but acts to some extent as a spreader also. (45,336.)

Many published spray recommendations include "soap" as a spreader, without specifying what kind, or specify one kind without regard to differences in conditions under which it may have to be used. Such recommendations may be undependable because of differences among soap—water contents varying from 8 to 70 percent, for example, and differences in jelling properties and in reaction to different temperatures (294).

Horsfall, although granting that oils, especially glyceride drying oils, are excellent stickers, deprecates the use of stickers and especially of spreaders. He points out that bordeaux mixture is naturally highly adhesive; that the inclusion of soap in a spray to make it cover the surface better also makes the spray more likely to run off before drying and to wash off in rains after it has dried;

²²Most of the information concerning these, unless otherwise noted, is from *Diseases of Forest-tree Nursery Stock* (223) and unpublished data of the Bureau of Plant Industry, Soils, and Agricultural Engineering.

that calcium caseinate, widely popular in the 1920's "has largely gone out because no one could demonstrate that it paid its way"; and that calcium caseinate and other proteinaceous colloids, although tenacious, have frequently interfered with the fungicidal action of the spray toxicants (336). It is noteworthy in this connection that few, if any, recommendations concerning either spreaders or stickers accompany specifications for treatment with the insecticides developed since World War II.

In contrast to Horsfall, Davis and coworkers say that "Spreaders or adhesives must be used if good results are to be obtained with fungicides on conifers" (223). This statement is borne out to some extent by difficulty in getting even the naturally adhesive bordeaux mixture to stick to pine seedlings in the cotyledon and early primary-needle stages, when spraying for fusiform rust. For such spraying, Santomerse S, a commercially available salt of substituted aromatic sulfonic acid in aqueous solution, has proved a satisfactory sticker with bordeaux, Fermate, and Zerlate.

Casein spreader (calcium caseinate; casein-soap; "Kayso") may differ considerably in efficiency from lot to lot. In general, calcium caseinate or any preparation of which it is an ingredient should not be used with any insecticide or fungicide noted as being incompatible with *lime*, or oil spreaders or stickers with those noted for being injurious in combination with oils. Calcium caseinate has been largely superseded by other stickers.

Raw linseed oil (boiled linseed oil is not recommended) is perhaps the most lasting sticker so far employed on southern pines, but is also among the most expensive, requires emulsification before use, and is extremely difficult to remove from sprayers, requiring prompt use of white gasoline for this purpose. It may injure foliage, but such injury to southern pines appears to have been negligible. Used with bordeaux mixture, linseed oil may be emulsified by simply pouring the oil into the bordeaux and pumping the two through the spray nozzle back into the tank. Used with other fungicides, linseed oil may have to be emulsified before mixing by agitating violently 6 pounds of the oil, 6 pounds of fish-oil soap, and 6 gallons of water (6-6-6 emulsion). An emulsion of linseed oil and fish-oil soap is nearly as good a sticker as straight linseed oil, and both have given better results than Santomerse in limited tests of trees sprayed in the plantation (pp. 110 and 132). Linseed oil has been used as a sticker mostly for bordeaux mixture applied to longleaf pine nursery seedlings at lifting time to reduce brown-spot infection after planting, and for bordeaux mixture applied semi-annually to planted longleaf pine; under these conditions the lasting quality of linseed oil at least partly offsets its cost.

"*Santoraersc.*" A spreader and sticker available in two forms, D, a powder, and S, a liquid. The latter has been widely used in southern pines, with good effect, in combination with Fermate and

Zerlate as well as with bordeaux mixture. It is one of the most effective stickers for spraying nursery seedlings in the cotyledon and early primary-needle stages to control fusiform rust.

Table 29 is a general guide to quantities of spreaders or stickers to use. Wherever more specific directions are given in connection with particular insects, diseases, insecticides, or fungicides, they should be followed.

MISCELLANEOUS BAITS, REPELLENTS, AND COATINGS

All the poisons in the baits described here are dangerous, and must be used with the precautions detailed on page 202. Use cover over baits on ground, or place bait in underground burrows or in places inaccessible except to mice or other harmful rodents.

Mouse Baits

1. For meadow and pine mice (271).

Steam-rolled oats	98 pounds.
Amber petroleum jelly	10 ounces.
Mineral oil	Do.
Zinc phosphide	1 pound.

Warm the mineral oil and the petroleum jelly together until fluid but not hot. Add zinc phosphide and stir briskly to suspend. Your suspension over the oats in open box or mechanical mixer and mix until the grains are evenly coated. The bait, which will keep for some time, need not be dried before sacking or use.

2. For field or white-footed mice (P55).

Powdered strychnine alkaloid ⁵⁵	1 ounce.
Baking soda	Do.
Rolled oats	8-10 quarts.
Beef fat	1 quart.

⁵⁵ Not strychnine sulfate, which is much less effective (255).

Mix the strychnine and soda together and sift uniformly over oats, stirring well; warm oats in oven, but do not scorch. Sprinkle heated beef fat over oats and stir till oats are uniformly coated. Use fresh, placing 1 teaspoonful in the middle of each 20- by 20-foot square; above quantity treats about 4 acres.

3. For white-footed mice (271).

Steam-rolled oat groats	125 pounds.
Thallium sulfate	1¼ pounds.
Water	1 gallon.
Dry gloss starch	½ pound.
Glycerine or petrolatum	¾ pint.

Dissolve the thallium sulfate in 3½ quarts of boiling water. Mix the starch with 1 pint of cold water, stir mixture into thallium solution, and cook until a clear paste is formed. Add the glycerine or petrolatum—though this may be omitted if bait is to be used immediately. Pour the mixture over the oat groats and mix until grains are uniformly coated. Use only enameled or wooden utensils; distribute with spoon or special dipper. Use on direct-seeding areas, either alone or 10 to

TABLE 29.—Quantities of spreaders and stickers commonly used with sprays on southern pines

Spreader or sticker	Spray with which used on southern pine ¹	Quantity recommended per 100 gallons of spray ¹	
		Usual	Range
Calcium caseinate or casein spreader (Kayso)	Bordeaux	4 lbs.	4 to 8 lbs.
Fish-oil soap	do	4 lbs.	
Linseed oil (raw)	do	10 qts.	4 to 15 qts.
Linseed-oil fish-oil-soap emulsion	Bordeaux and others	5 qts.	4 to 9 qts.
Ortho-spreader	Lime-sulfur	2 lbs.	
Resin fish-oil soap	General	4 lbs.	
Rosin-residue emulsion (HCL sticker)	Bordeaux	1 pt.	
Santomerse D	do	4 ozs.	
Santomerse S	Bordeaux, Fermate, and Zerlate	1 pt.	½ to 1 pt.
Silmo (Spread-ol)	Bordeaux	1 pt.	
Soap	{ Lubricating-oil emulsion	14½ lbs.	
	{ Nicotine sulfate		2 oz. to 3 lbs.
Whale-oil soap	Bordeaux	4 lbs. or 2 qts.	

¹ As recorded in literature and unpublished data cited for insecticides, fungicides, and spreaders and stickers.

20 days after a preliminary strychnine bait (formula 2), placing 1 teaspoonful in the middle of each 20- by 20-foot square.

Always cover each bait with a piece of bark, a chip, or other cover under which mice and only mice ordinarily run.

Never touch or handle thallium baits with the bare hands.

4. For house mice (also pocket gophers) (271).

Milo maize	6 pounds.
Thallium sulfate	1 ounce.
Water	9 fluid ounces.
Gloss starch	1 tablespoonful.
Heavy corn sirup	1 fluid ounce.

Dissolve the thallium sulfate in 7 ounces boiling water. Mix starch with 2 ounces cold water, add sirup, and stir into boiling thallium solution. Cook until mixture begins to thicken, then pour over milo maize and mix until grains are evenly coated. Spread out to dry before using or sacking. Never touch thallium baits with the bare hands.

Pocket Gopher Baits

1. Cut carrots or sweet potatoes into pieces 1/2 by 1/2 by 1 1/2 inches. Over 2 quarts of pieces sift 1/8 ounce of powdered strychnine alkaloid (not strychnine sulfate), stirring while sifting.

2. Mix 3/4 pint cold water and 2/5 ounce laundry starch; bring to a boil, stirring constantly; cook to a smooth paste. Then stir into the paste 1/4 pint corn sirup, followed by 1/2 ounce glycerine.

Then mix, dry, in a 1-gallon container 1 ounce powdered strychnine alkaloid and 1 ounce baking soda.

Pour the hot paste over the dry mixture, stirring thoroughly while pouring.

Pour the whole mixture over 16 quarts of plump wheat kernels or steam-rolled oats. Stir till the kernels are well coated; then spread out until dry.

3. See mouse bait No. 4 (milo maize).

Planting the Southern Pines

Rabbit-Repellent Spray

A rabbit-repellent spray may be applied to slash, loblolly, or shortleaf pine seedlings a few days before lifting, by means of a straddle-bed sprayer equipped either with a 1-bed roller preceding a regular 1-bed spray boom, or with a similar roller and an extension hose and hand nozzle operated by a man following the sprayer on foot. The roller is adjusted to bend the seedlings gently as the spray hits them, to insure coverage of the vulnerable portions of the stem just above the root collar. With the bar and boom combination, the sprayer should pass over the bed twice, from opposite directions.

Copper carbonate-asphalt emulsion mixture.— Mix 3 pounds asphalt emulsion and 2 quarts of water; add 2 pounds copper carbonate and mix; dilute with 8 additional quarts of water, and mix. Apply at rate of 1 1/2 to 3 pints per 1,000 trees.

There are additional effective sprays and lists of sprays found ineffective against rabbits or injurious to trees (146, 272).

Foliage Coatings to Reduce Transpiration

1. Lanolin emulsion:

Lanolin (anhydrous)	100 grams.
Adeps Lanae)	
Monoethanolamine	10 grams.
stearate.	
Water	1 liter.

2. Dowax:

Commercial Dowax emul-	1 part by weight.
sion.	
Water	3 parts by weight.

In Marshall and Maki's tests (479), the seedling tops were dipped in one or the other of these coating materials, but either material may also be sprayed.

PLANT QUARANTINE AND NURSERY
INSPECTION OFFICIALS 54

- Alabama
Chief, Division of Plant Industry, Montgomery 1.
- Arkansas
Chief Inspector, State Plant Board, Little Rock.
- Delaware
State Board of Agriculture, Newark.
- Florida
Plant Commissioner, State Plant Board, Gainesville.
- Georgia
Director of Entomology, State Capitol, Atlanta 3.
- Illinois
Inspection Supervisor, 300 State Bank Building, Glen Ellyn.
- Indiana
State Entomologist, Indianapolis.
- Louisiana
State Entomologist, Capitol Station, Baton Rouge.
- Maryland
State Entomologist, College Park.
State Plant Pathologist, College Park.
- Mississippi
Executive Officer, State Plant Board, State College.
- Missouri
State Entomologist, Department of Agriculture, Jefferson City.
- New Jersey
Chief, Bureau of Plant Industry, Trenton 8.
- North Carolina
State Entomologist, Department of Agriculture, Raleigh.
- Ohio
Division of Plant Industry, Department of Agriculture, Columbus.
- Oklahoma
State Board of Agriculture, Oklahoma City 5.
- Pennsylvania
Director, Bureau of Plant Industry, Harrisburg.

- South Carolina
Crop Pest Commission, Clemson College.
- Tennessee
State Entomologist, University of Tennessee, Knoxville.
- Texas
Chief, Division of Plant Quarantines, Department of Agriculture, Austin.
- Virginia
State Entomologist, 1112 State Office Building, Richmond 19.

WIRE SCREENS TO PROTECT SEED
SPOTS

A pattern (498), cut to the dimensions shown in fig. 53, makes a cone standing about 5 inches high with a basal diameter of about 4.5 inches at the soil surface, when the wire is set to a maximum depth of 2 inches. Cones may be of $\frac{1}{2}$ -, $\frac{1}{3}$ -, or $\frac{1}{4}$ -inch hardware cloth, or $\frac{1}{16}$ -inch mesh screen wire. The dimensions permit cutting 36-inch wire into 5 strips or 30-inch wire into 4 strips. Waste is negligible.

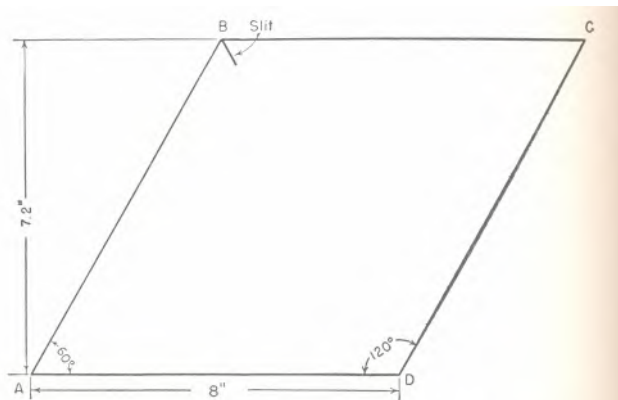

FIGURE 53.—Pattern for hardware-cloth or screen-wire cone to protect seed sown in prepared spot (498).

In shaping the cone, the wire is rolled to bring edges AB and BC together. The slit at B facilitates lapping the edges, which are then wired or stapled together. For quantity production the wire cones may be rolled by means of a fixed or revolving wooden cone of appropriate taper, with a groove 8 inches long and $\frac{1}{2}$ inch deep running down from its apex to take edge AB of the wire. The finished cones nest conveniently.

When the cone is installed, corner D and corners A and C (joined) project somewhat deeper into the soil than the middles of sides CD and DA.

Domes made from hardware-cloth disks (*en*, 370) appear less economical than the cones.

⁵⁴ Taken from *Entoma* (46).

PINE SEED DEWINGER

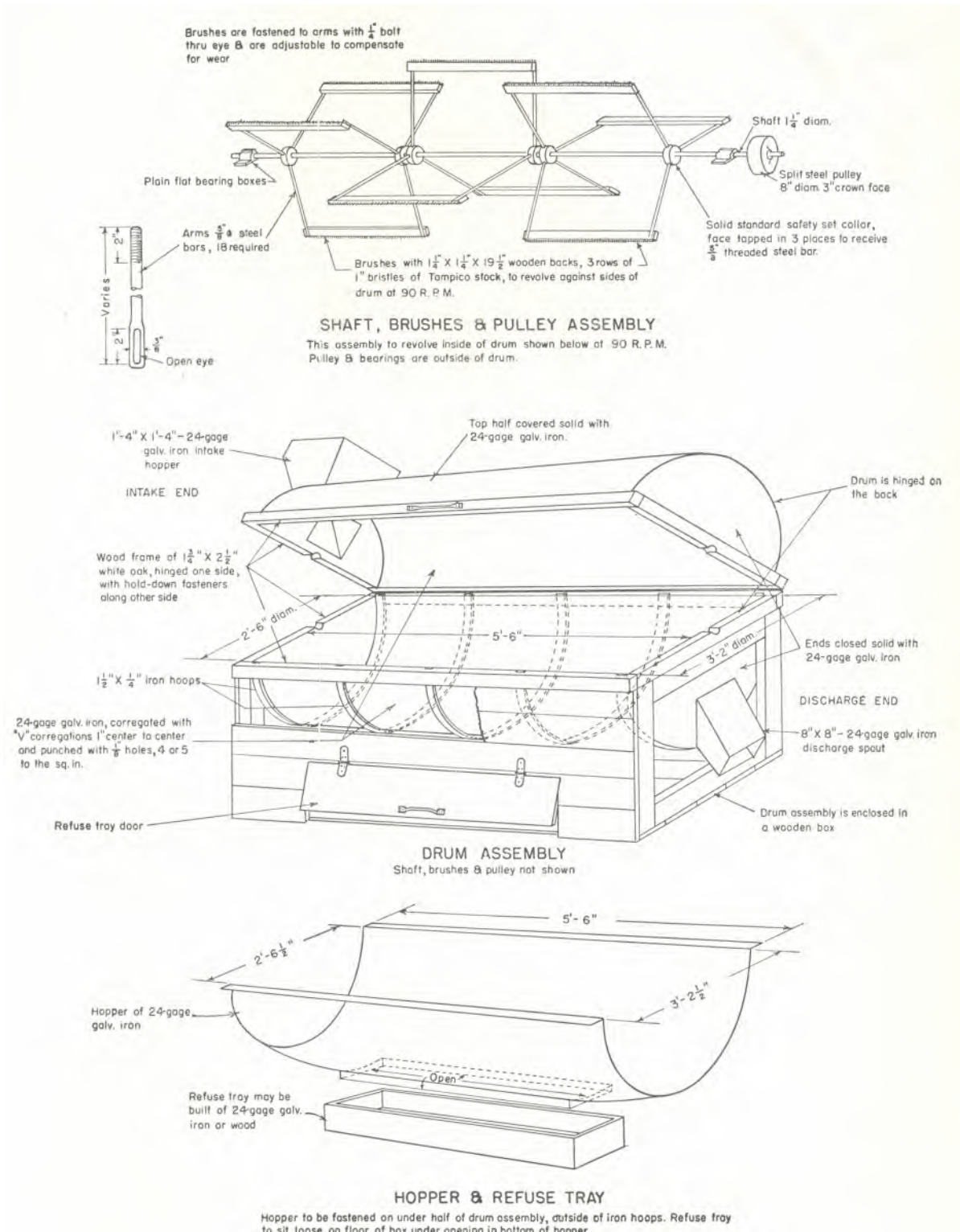

FIGURE 54.—Detailed construction of pine seed dewinger used by Region 8, U. S. Forest Service.

GUIDE TO DRYING OF SEED

Figure 55 permits direct reading of the net weight to which a lot of seed of known moisture content percent (oven-dry basis) and known net weight at time of sampling must be dried to reduce it to a specified moisture content percent.

For seed lots weighing less than 10 pounds, one decimal place may be pointed off in all values in

the left-hand and right-hand vertical scales. For seed lots weighing more than 200 pounds, the desired weight may be totaled from readings for successive lots of 200 pounds each, plus a final lot of less than 200, or else all values in both vertical scales may be multiplied by 10.

To use the chart, find the point on the right-hand scale corresponding to the net weight of the seed lot when the moisture-content samples were

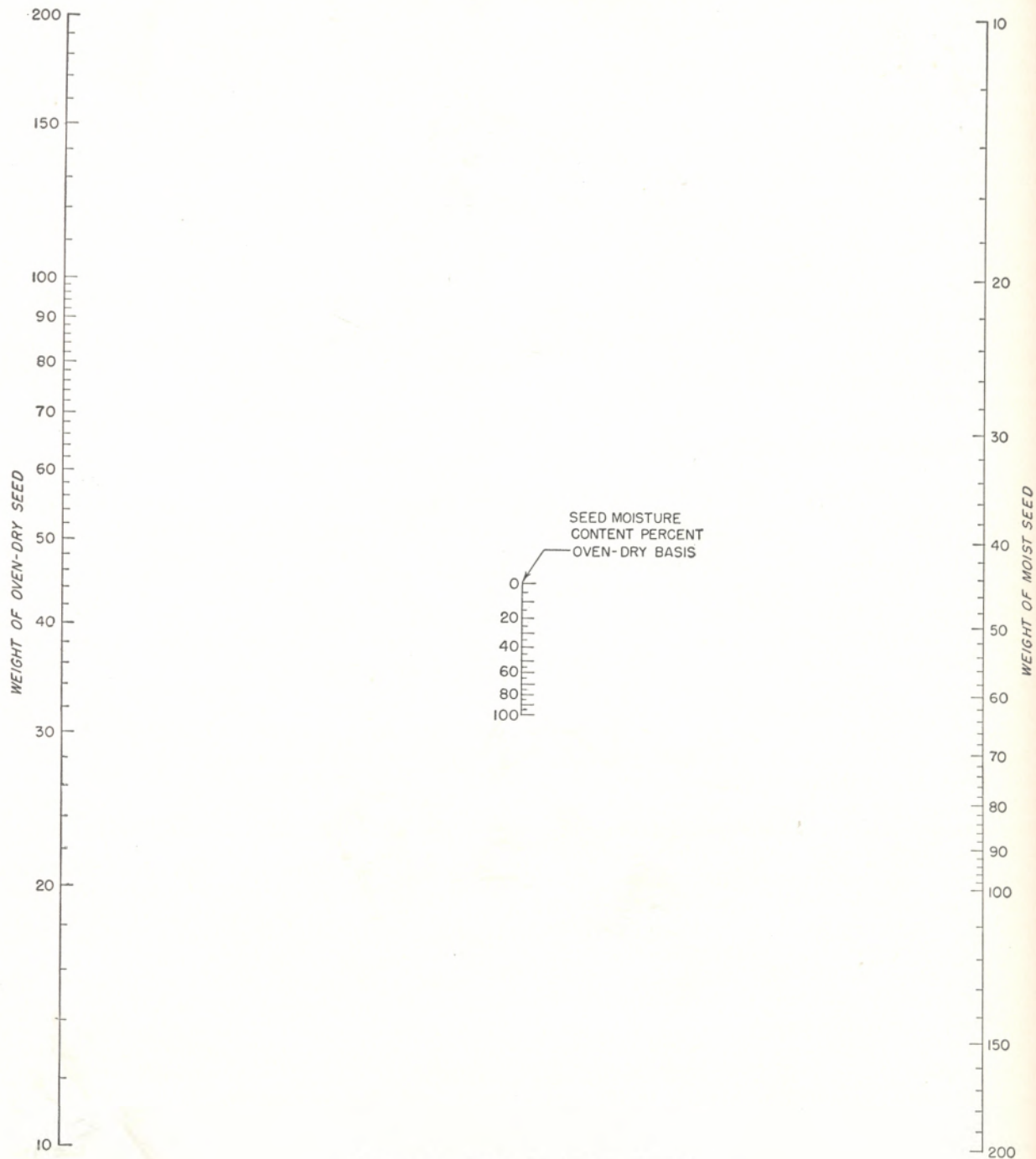

FIGURE 55.—Guide to drying of seed.

drawn. Lay a straightedge across this point on the right-hand scale and the point on the center scale corresponding to the moisture content percent determined from the sample. Note the point of intersection of the straightedge with the left-hand scale.

Now lay the straightedge across this intersection point on the left-hand scale and across the point on the center scale corresponding to the moisture content percent to which the seed is to be dried. The reading where the straightedge intersects the right-hand scale is the net weight to which the seed lot must be dried.

Example.—A lot of slash pine seed weighed 243 pounds net when sampled for moisture content. The moisture content proved to be 17 percent. To what net weight must the lot be dried to reduce its moisture content to 8 percent? *Solution:* Straightedge from 200 on right-hand scale through 17 on center scale gives 170 on left-hand scale. Straightedge from 170 (left) through 8 (the desired moisture content) on center scale gives 184 on right-hand scale. This is the weight to which the first 200 pounds of the 243 must be dried. In like manner the last 43 pounds must be dried to 40 pounds, making 184 plus 40, or 224 pounds, the net weight to which the 243-pound lot at 17 percent must be dried to reduce its moisture content to 8 percent.

SEED-SAMPLING PROBES

A grain trier or probe satisfactorily draws 100-seed or larger samples of southern pine seed, except longleaf, from sacks or cans. The probe consists of two slotted tubes, one turning inside the other to close the slots or to open them and admit seed into the inner tube. For most purposes a 30-inch by 1/2-inch probe is convenient; if it draws too large a sample of a small-seeded species, patches can be taped or soldered over some of the slots. Agricultural supply dealers usually can supply probes or tell where to get them.

Longleaf seed, because of the persistent wings, needs a special probe about 2 1/2 inches in diameter. One practical homemade form consists of a long outer cylinder of galvanized iron heavy enough to resist easy denting. This outer cylinder is closed at both ends, with the lower end finished in a blunt point. Inside the lower end is a shorter cylinder, closed at its upper end only, and rotated by means of a 1/4-inch iron rod projecting through the upper end of the long cylinder (fig. 56). Gates in the outer and inner cylinders are turned opposite each other to admit a sample of seed.

A probe with the dimensions shown in figure 56 draws a sample of about 100 longleaf seeds with wings attached. For drawing samples of 100 seed with wings reduced to stubs, it may be made with shorter gates, or the inner cylinder may be shortened with pieces of cork cemented into place.

DIRECTIONS FOR GERMINATION TESTS

A. Facilities, Material, and Apparatus

1. Ample table and floor space (where sand, if used, and water will do no harm) for setting and conducting tests; an adequately lighted room with temperatures suggested in table 15, and, for sand flats, with a relatively moist atmosphere (to prevent too rapid drying of sand), for running tests after they have been set up.

2. Some device for measuring maximum and minimum temperatures daily throughout course of tests—a Sixe's maximum-minimum thermometer (and magnet) if a recording thermograph is unavailable.

3. Supply of water-resistant cardboard or roughened, opaque plastic tags (and thumb tacks for sand flats) for permanently labeling each subsample and marking boundaries between subsamples.

4. Small tweezers, with rounded rather than very sharp points, for pulling germinated seeds.

5. A supply of forms for recording germination, preferably a separate form for each 800-seed sample. The simplest, perhaps, is a letter-sized form (fig. 57).

6. Numerous envelopes and small trays for seed sam pies.

Items 7 through 17 are required only for sand-flat tests.

7. Clean quartz sand, fairly uniform in texture, and free from harmful fungi, from organic matter, and from substances that will cause the surface to cake when dry. Suitable sand usually can be obtained from sand bars along small streams or lakes, sometimes from well borings. Sea sand must be washed thoroughly to free it from salt. Regardless of source, the sand must be fine enough to hold water well. It should be sifted through 1/16-inch mesh wire. Dry samples should not appear finer than the grit on No. 0 sandpaper or coarser than that on No. 1 1/2; sand closely matching No. 1/2 or No. 1 should be about right.

8. Platform scales (about 150 pounds capacity) to weigh full and empty containers of sand and of water.

9. Ample containers for sand and water; two tight wooden boxes, two galvanized iron washtubs, and one 12-quart pail are about the minimum. Include shovels, scoops, or trowels for handling sand.

10. Four sand flats per sample of longleaf seed, and two flats per sample of each other species; flats of wood, 10 1/2 by 10 1/2 by 3 1/2 inches inside, with smooth edges to permit leveling sand with straightedge, and no cracks through which dry or overwet sand may escape.

11. One mouse-proof screen-wire cover per flat, folded from about 13 1/2 by 13 1/2 square of 1/16-inch mesh, preferably aluminum screen wire.

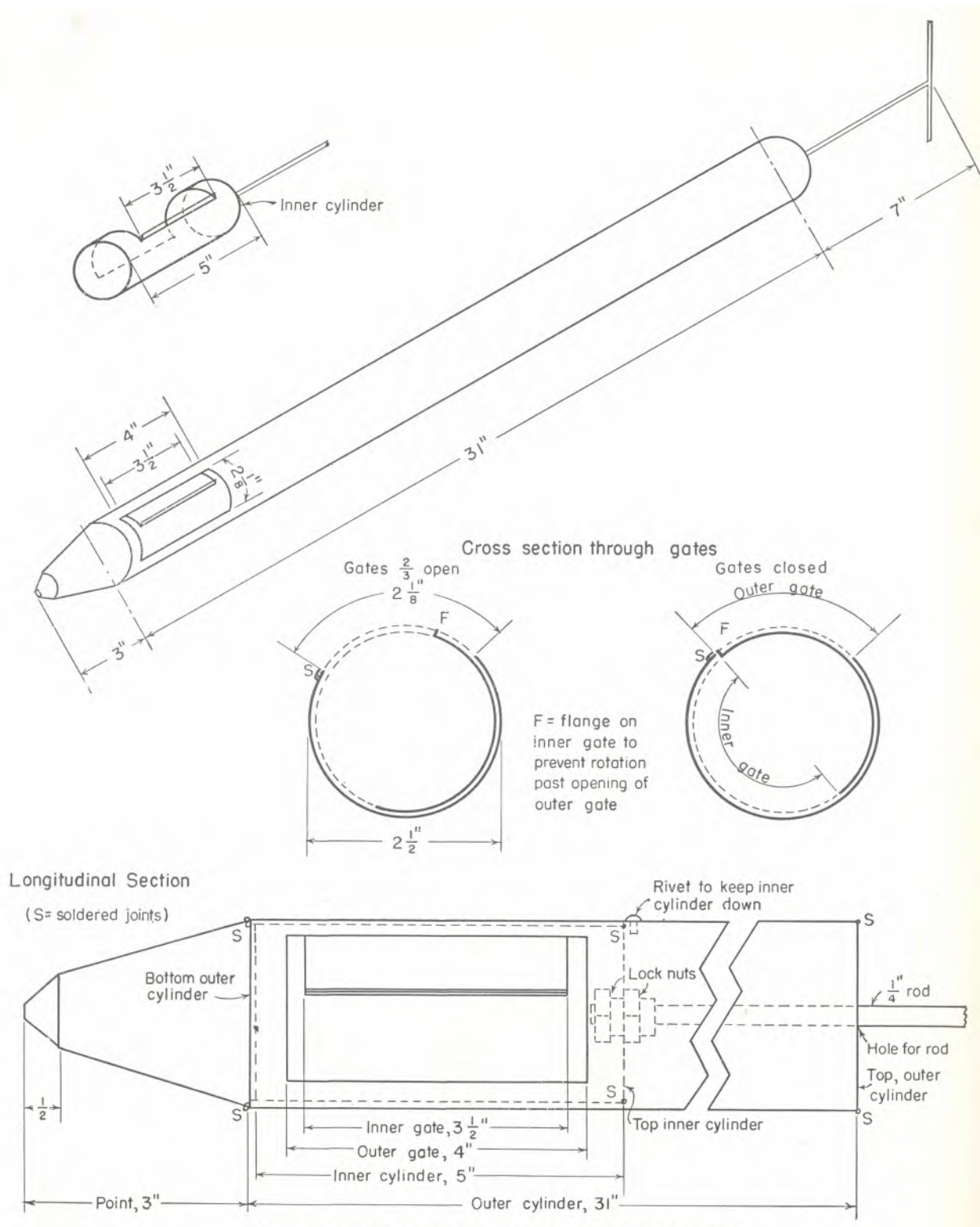
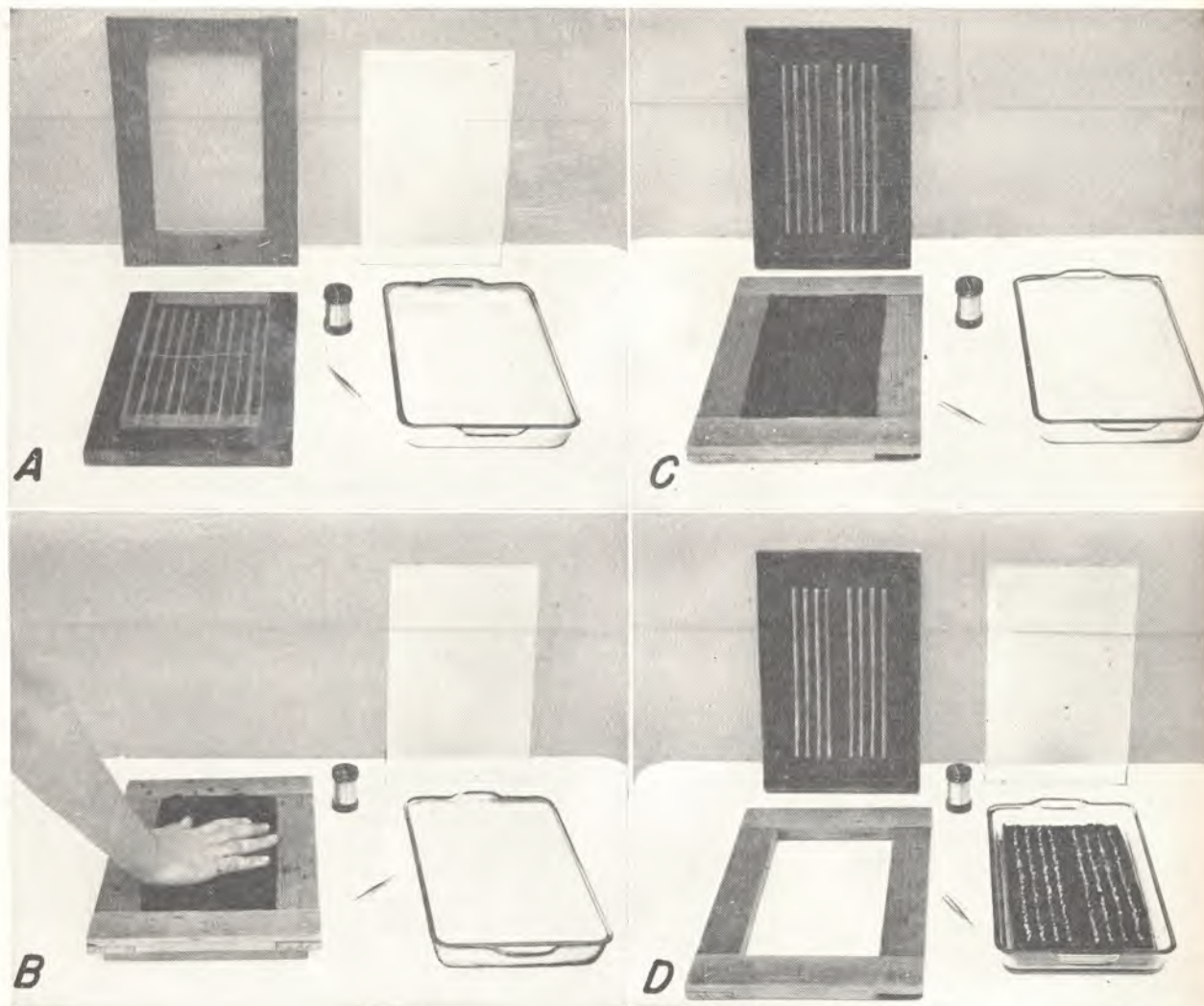

FIGURE 56.—Special probe for sampling longleaf pine seed.



F-465245-8

FIGURE 59.—Construction and use of peat mat for germination test. *A*, Mold with screen-wire collar and copper-wire cross braces in place. *B*, Frame in place around collar; peat being compressed to $\frac{3}{4}$ -inch thickness. *C*, Mold removed from mat after inverting cover glass, frame, and mold. *D*, Mat in place in dish; 200 longleaf seeds in place on mat.

inches, centered on the board. Measure the $10\frac{1}{2}$ and $6\frac{1}{4}$ inches to the *outsides* of the nails; for convenience in construction, pencil this $10\frac{1}{2}$ - by $6\frac{1}{4}$ -inch rectangle on the board. Cut the heads off the nails, leaving exactly three-fourth inch of each nail projecting above the board; file off any roughness on the nails; bend each nail very slightly toward the center of the board.

Now draw 9 parallel lines, five-eighths inch apart, lengthwise of the $10\frac{1}{2}$ - by $6\frac{1}{4}$ -inch rectangle on the board, dividing the rectangle into 10 exactly equal parts.

On each of these 9 lines except the middle one, fasten with fine brads a triangular wooden strip, so that its ridge or apex lies directly over the pencil line (fig. 59 *A* and *C*). Each strip is $9\frac{1}{2}$ inches long; its ends lie one-half inch inside the ends of the $10\frac{1}{2}$ - by $6\frac{1}{4}$ -inch rectangle. The surface of the strip in contact with the board is one-fourth

inch wide. The ridge or apex of the strip is three-sixteenths inch above the board.

Smooth the strips and the exposed surface of the board between them with steel wool or fine sandpaper, warm the board, and pour over it a thin coating of melted paraffin. This coating, which must be renewed from time to time, keeps the peat from sticking to the mold.

Make the *frame* of four 2-inch strips exactly three-fourths inch thick, half-lapped at the corners to lie flat on the mold (figure 59, *B*). Thickness of exactly three-fourths inch is important, as it determines the thickness of the finished peat mat. The inner opening of the frame should be just enough larger than $10\frac{1}{2}$ by $6\frac{1}{4}$ inches to let the frame fit easily but not loosely over the four nails in the mold when the nails are surrounded by the screen-wire collar (59, *A*) used in making the mat. The easiest way to make the frame the right size

is to mark and cut the pieces and fit them together around a collar in place on the nails.

B. Preparing Sand Flats

1. Weigh a suitable quantity of dry sand.
2. To this sand add 15 percent of water by weight, and mix until sand is uniformly moist throughout.
3. Fill each fiat heaping full of moist sand, and drop it twice for distance of 6 inches onto solid table or floor to settle the sand. Pack all the sand within 1 ½ inches of each corner lightly with the fingers as further safeguard against settling later watering; fill resulting finger marks with moist sand.
4. If formaldehyde sterilization is necessary, strike off excess moist sand level with edges of sand flat, by means of straightedge, and apply formaldehyde as specified on page 210; at same time, soak with formaldehyde a thin layer of sand spread on heavy paper, and allow to dry for use in step C-6.
5. With appropriate edge of scraper (figure 58), remove excess moist sand, leaving level surface three-sixteenths inch (for longleaf pine) or one-eighth inch (for other southern pines) below top of sand flat.

C. Setting Up Sand-Flat Tests

1. With temporary partitions, divide level surface of sand in flat (step B-5) into halves (for longleaf pine) or quarters (for other species).
2. Place counted subsamples of 100 seeds each on sand, at rate of 100 seeds, per half flat for longleaf and 100 per quarter flat for other species; scatter seeds evenly to avoid contact between them.
3. Tamp longleaf, slash, or loblolly seeds gently to make sure each seed lies flat and none projects above top of flat. (Do not tamp shortleaf seeds; to do so may result in covering them too deeply.)
4. With partitions still in place, mark on the edges of flat, with crayon or soft pencil, the number and letter of each 100-seed subsample, and the ends of the strips occupied by the partitions.
5. Remove partitions.
6. Cover seeds with dry sand to slightly above edges of flat, being careful not to move seeds into contact one with another, or into or across space formerly covered by partitions.
7. Strike off excess dry sand level with edges of flat, by means of the straightedge.
8. Mark each 100-seed subsample with permanent cardboard or plastic label in pencil (ink will run), corresponding to temporary crayon label; mark boundaries between 100-seed subsamples with thumb tacks in edges of flats.
9. Water the dry sand until it appears about as moist as sand with which flat was originally filled. Recover carefully with sand any seeds exposed during watering.

10. Cover each flat with mouseproof wire screen and place in germinating room to germinate, with thermometer in midst of flats.

D. Preparing Peat Mats

Mats sometimes mold if made too long before being used, but may safely be made any time within 5 days of setting up the tests.

1. Crumble some peat into tub; add water, mixing thoroughly, until all peat is moist and a little water can be squeezed from any handful picked up, but not until there is much free water in bottom of tub. Preferably, peat should stand at least an hour, but not over night, between wetting and use. The cooler the peat when molded into mats, the less will it stick to the mold.
2. Turn mold nail-side-up on table. From each end of a 3 1/6- by 3 1/4-inch strip of screen wire remove three cross-strands and bend the free ends of lengthwise wires at right angles to the strip. Stretch strip tightly around nails on mold, pinching corners square at nails; fasten shut by means of free ends of lengthwise wires to form a collar (fig. 59, **A**).
3. Fasten one lengthwise and one crosswise brace of fine copper wire across the collar, being careful not to pull ends or sides of collar inward (fig. 59, **A**).
4. Slip frame down over collar (fig. 59, **B**).
5. Starting with the space under the intersection of the wire crossbraces, and going next to the sides and ends of the collar, fill the collar slightly more than level full of peat squeezed moderately free of excess water; be careful to get as little peat as possible between collar and frame. The exact level to fill to varies with texture and wetness of peat, and is determined by trial for each new batch.
6. With the hands, compress peat to a firm mat with a smooth surface level with the surface of the frame (fig. 59, **B**).
7. Lay a cover glass over the exposed surface of the peat mat; holding glass, frame, and mold firmly together with both hands, invert them and lay them, glass side down, on the table.
8. The mold is now on top. Remove it gently, reaching in between mold and frame to remove collar from nails and work it down into frame again if collar catches on nails. Mat should present unbroken surface, as in figure 59, **C**. If patches of peat remain sticking to mold, use colder water, squeeze peat drier, or rewax mold.
9. Lift frame from around collar, leaving finished peat mat on cover glass; be careful not to crack mat in process.
10. Hold cover glass and mat over dish at slight slant. Hold finger of one hand against middle of long side of mat. With single quick, smooth movement of other hand, slide glass sidewise from under mat, allowing mat to drop unbroken into dish (fig. 59, **B**). Center the mat exactly in dish.

E. Setting Up Peat-Mat Tests

1. Thoroughly mix sample of seed and spread out on smooth surface, as cover glass or sheet of letter paper.

2. Taking seeds at random in twos and threes, to a total of 25, push them from smooth surface onto 9 1/2- by 2-inch metal strip ; push into approximately equal spacing along whole length of unbent edge of strip.

3. Holding strip by upturned edge, pour seed off unbent edge into first groove in surface of peat mat. Few of the seeds should touch each other as they lie in the groove ; if many touch, or any pile up, rearrange them with tweezers.

4. Repeat process with next 3 grooves, completing setting of 100-seed subsample.

5. Repeat on other half of mat (fig. 59, D), and on successive mats, till eight 100-seed subsamples have been set. (For assured accuracy, check count of 25 seeds in each groove.)

6. Label each 100-seed subsample with number and letter on bit of plastic tucked between peat and wire collar; be sure labels do not project above top of dish.

7. Pour water carefully between mat and side of dish until one-eighth to one-fourth inch deep ; after some or all of it has soaked up, repeat, until one-sixteenth to one-eighth inch of free water remains in bottom of dish.

8. Place cover glass over dish and place seeds to germinate. (Or place in refrigerator at 38° to 41° F. for pregermination treatment ; 35° F. is too low for pregermination treatment of seeds on peat mats, as, even under cover glasses, evaporation from the peat results in a temperature lower than that of the refrigerator.)

F. Care of Tests

1. Sand flats and peat mats should be inspected daily for moisture, progress of germination, and injuries.

2. Sand flats usually must be watered at least once a day—twice a day or more often if the humidity is low or there is much air movement. The sand in contact with the seed must be kept perceptibly moist at all times, but never so wet as to surround the seed with a film of water. After the first 2 or 3 days, peat mats seldom require watering more often than every fifth to tenth day.

3. Seed in sand flats must be kept covered one-eighth inch deep, measured to the center of the seed. Shallower covering may result in harmful drying and deeper covering may seriously reduce both rapidity and completeness of germination by cutting off light.

4. On peat mats some mold invariably develops. If it becomes very heavy, it may be broken up and removed with tweezers. In extreme cases, wash the seeds in tapwater and transfer them to fresh mats.

5. Maggots are controlled by removing with tweezers.

G. Recording Germination

1. Record germination on suitable forms (A-5) every 5 or 7 days, whichever proves more convenient ; if germination is so rapid as to confuse counts at these intervals, record it every 2 or 3 days.

2. Record germination both by calendar dates and by days since start of test. For example, if a test is set up January 24, record germination on February 8 as having been observed on the fifteenth day. To get the number of days, count all days, including the day of observation, *after* the day on which the flats or mats were first exposed to warmth and light. In the case of a sample first stratified and then tested in flats or on mats, this means only the days after it was transferred from the refrigerator to the germinating room, and does not include days in the refrigerator.

3. At each count, to simplify later interpretation of results, record separately, for each 100-seed subsample (A, B, ___H) the *total* normal germination percent to date. For each subsample, this is obtained by adding the percentage observed on the current day to the total percentage recorded at the last previous count.

4. In sand-flat tests, count no seed as germinated until it has lifted its seed coat above the sand. If the sand tends to crust, the flat should be watered just before the count.

5. In peat-mat tests, count no seed until the radicle (root) turns definitely downward.

6. Record the percentage of abnormally germinating seeds in each subsample by means of a dot tally, without regard to date, in the space provided near the bottom of the form. If it is doubtful whether a seed is germinating normally, leave it until the next count to make sure. Common abnormalities are :

- (a) End-splitting, which includes conspicuous swelling, wide opening of the crack in the seed coat, and usually the protrusion of a small nipple, which, however, fails to elongate and turn downward.
- (b) Protrusion of a thickened, blunt, or sometimes conspicuously constricted horizontal radicle which, instead of turning downward, grows horizontally or even turns upward.
- (c) Similar horizontal elongation of the hypocotyl (seedling stem) practically without growth of the radicle.
- (d) Protrusion of the green cotyledons instead of the radicle.

A gelatinous cap or coating on the protruding radicle is not of itself a sign of abnormality. Count a polyembryonic seed—one germinating with two or more radicles—as one normal seed unless germination is otherwise abnormal.

7. Pull and discard all normally and abnormally germinated seeds as counted, to simplify later counts and avoid counting any seed twice.

8. If the results of the test are to be used to determine sowing rate by the formula based on full seed only (p. 75), cut the seeds remaining ungerminated at the end of the test, and record for each subsample the percentages sound, spoiled, and empty. For each subsample, these percentages plus the total percentages of normal and abnormal germination at the end of the test should equal 100. Germination percent based on full seed only

$$= \frac{(\text{Total normal germination percent})}{100 - (\text{Total percent empty})} \times 100$$

and is calculated from the average percentages for all subsamples.

ACIDIFICATION OF NURSERY SOIL TO CONTROL DAMPING-OFF

For acidifying soil to control damping-off, either sulfuric acid or aluminum sulfate may be used. Get the strongest commercial grade of concentrated acid (specific gravity at least 1.8), or the ordinary technical granular grade of aluminum sulfate—not "alum," which ordinarily means potassium aluminum sulfate.

Where rates of application have not been worked out and proved effective, apply either sulfuric acid or aluminum sulfate to small test plots at the rate most appropriate for the pH of the soil involved (table 30). A preliminary idea of effectiveness can be got from the pH concentration of the surface one-half inch on the treated plots, 3 days after treatment. If it has dropped below 4.0, the application has been too heavy; if it is still above 5.0, too light. If at all possible, a crop of seedlings should be grown on treated test plots before treating any large fraction of the nursery.

Aluminum sulfate may be applied dry, or dissolved in 1 to 2 pints of water per square foot (125 to 250 gallons per 1,000 square feet) of bed. Sulfuric acid is always applied in water solu-

tion. Wilde condemns strongly the usual recommendation of applying the acid in 1 or 2 pints of water per square foot of bed regardless of the amount of acid used, and emphasizes that, for effective control of damping-off without excessive injury to soil, the amount of water used must be such that the prescribed amount of acid per square foot is not more than 2.0 nor less than 1.5 percent, by volume, of the solution (782).

The usual recommendation is to make the application immediately after sowing. This is feasible with southern pines only where a soil cover is used. With cloth or pine-straw bedcovers, treatment should precede sowing, and sowing should be done with the minimum possible freshening of the treated surface. Treated beds must be kept continuously moist until all seedlings have emerged, to prevent chemical injury to germinating seeds and small seedlings.

Sulfuric acid is corrosive to equipment, and usually requires lead-pipe sprinklers, paraffin-coated wooden vessels, and other special equipment for application. *It is dangerous to handle.* Workmen should wear felt or woolen hats, shirts, pants, and underclothes; face masks or goggles; rubber outer garments, especially boots, aprons, and gauntleted rubber gloves. Never open a sulfuric-acid container with the face over the opening or with the opening toward another person. Never empty it by any pressure method; pour or siphon out the acid. Never pour water into sulfuric acid; always pour the acid into the water, slowly. Do not use sulfuric acid without carefully instructing crew in safe handling, and in first-aid measures for acid burns. The Interstate Commerce Commission has strict rules concerning the labeling and shipment of sulfuric acid, and return of containers. For further details, see latest Department of Labor safety rules for use of sulfuric acid (obtainable from the Superintendent of Documents, U. S. Government Printing Office, Washington 25, D. C.) and the Red Cross first-aid textbook. (47,95,110,023,302,780.)

TABLE 30.—Quantities of sulfuric acid or aluminum sulfate recommended for trial control of damping-off on various soils

Initial pH of soil	Sulfuric acid				Aluminum sulfate			
	Per square foot		Per 1,000 square feet		Per square foot		Per 1,000 square feet	
	Sandy soil	Heavy soil	Sandy soil	Heavy soil	Sandy soil	Heavy soil	Sandy soil	Heavy soil
	Fluid ounces	Fluid ounces	Gallons	Gallons	Ounces	Ounces	Pounds	Pounds
5.0	0	1/16	0.00	0.49	0	1/4	0.0	15.6
5.5	1/16	3/32	.49	.73	1/4	3/8	15.6	23.4
6.0	3/32	1/8	.73	.98	3/8	1/2	23.4	31.2
6.5	1/8	3/16	.98	1.47	1/2	3/4	31.2	46.9
7.0	3/16	1/4	1.47	1.95	3/4	1	46.9	62.5
7.5	1/4	5/16	1.95	2.44	1	1 1/4	62.5	78.1
8.0	5/16	3/8	2.44	2.93	1 1/4	1 1/2	78.1	93.7

DIRECTIONS FOR SEEDLING INVENTORIES

A. Equipment and Materials

1. One or more sampling frames, light, but rigid enough to prevent distortion in handling; each exactly 1 foot wide (inside measurement), and long enough (usually 4 feet) to cover the width of the bed occupied by seedlings. Steel welding rods, or flat steel strips reinforced with one or more cross bars, make a satisfactory frame.

2. Published set of random numbers (532, 676), or 2 sets of lotto or bingo numbers running from 0 to 40 (for 400-foot beds ; from 0 to 50 or 100 for beds 500 to 1,000 feet long) and 0 to 9, respectively.

3. Steel tape 50 or 100 feet long.

4. Detailed map of nursery showing species, seed sources, dates of sowing, and variations in cultural treatment for crop of seedlings to be inventoried, together with location of sprinkler lines and individual beds.

5. A supply of record forms, headed as follows, with 20 or 25 lines per sheet :

Nursery Inventory							
(Name) _____							
Compartment number _____		Species _____		Date of inventory _____		Seed source _____	
Recorder _____		Date sown _____		Cultural treatment _____		Uniformity of stocking _____	
Measurement started N E S W end of bed (circle one).							
Bed number	Distance along bed	Living seedlings	Plant-able seedlings	Bed number	Distance along bed	Living seedlings	Plant-able seedlings
	<i>Feet</i>	<i>Number</i>	<i>Number</i>		<i>Feet</i>	<i>Number</i>	<i>Number</i>

6. If the percentages of living seedlings that are plantable are to be determined by examining roots as well as tops, an ample supply of tall, stiff wire pins, looped at the top and flagged with bright cloth.

B. Preparation for Sampling

1. Determine the units (p. 96 and table 19) into which the nursery must be divided for inventory. Mark these units plainly on the nursery map and label each in terms of species, seed source, period of sowing, distinctive cultural treatment, damage, and uniformity of stocking.

2. Choose a suitable intensity of sampling for each unit and determine the number of samples to be counted by using as guides table 19, its footnote 1, and the uniformity of the stands. As an example, assume an October inventory of a nursery unit of twenty 400-foot beds which inspection and ocular estimate or a few preliminary counts show to be fairly uniformly stocked at a rate of about 30 seedlings per square foot. Such a unit, which should contain almost 1,000,000 seedlings, might best be inventoried by means of a 2-percent estimate. This would require counting 160 samples, 8 samples per bed. For units containing differ-

ent numbers of beds, see table 19; for beds of unequal sizes, see page 96.

3. Fill out the headings at the top of enough forms to hold the counts of seedlings in the samples for each nursery unit. Entries at the tops of the forms will correspond essentially to unit labels on the nursery map.

4. Select, by means of the table of random numbers (or lotto numbers) , the points at which the beds within the unit are to be sampled and enter their positions on the forms in numerical order from the north end (to choose a specific illustration) of the lowest-numbered bed in the unit to the south end of the highest-numbered bed. (In the present example, with 8 samples to be taken in each 400-foot bed, locate the sampling points for each bed in turn by drawing, at random, 8 different numbers within the range, 1 to 400, inclusive.) Arrangement in numerical order on the form is essential to prevent confusion and backtracking while counting samples in the nursery.

5. If the plantable seedlings in the unit are to be estimated by digging part of the samples, choose 20 sampling positions (or up to 40 if seedling development is very irregular), by means of the table of random numbers, from the entire series of sampling positions listed on the forms. Circle the chosen positions in red on the forms so that the corresponding samples can be marked with wire pins when counted.

C. Making Sample Counts

1. In the nursery, pace down the first bed of the unit to the point where, as indicated on the prepared form, the first sample is to be taken. (If blank spaces occur in the bed, do not count the steps required to pass them.) Mark the distance paced in the nursery path, without examining the bed.

2. Turn to the bed and ease the sampling frame down among the seedlings, at right angles to the length of the bed, and exactly opposite the distance mark in the path. *Do not move the frame to either side to include or exclude better or poorer looking portions of the seedling stand;* doing so almost invariably reduces the accuracy of the inventory.

3. Count the living seedlings within the frame, and record the number on the form in the column headed "Number of living seedlings," opposite the distance designating the position of the sample. Except with longleaf, count only those seedlings whose root collars lie wholly inside the frame; with longleaf, count any seedling having half or more of its root diameter inside the frame.

4. If the number of plantable seedlings is to be estimated on the basis of top development, count also, in each sample, the seedlings whose tops indicate they will be plantable at lifting time. Record the number of plantable seedlings to the right of the number of living seedlings.

5. If the number of plantable seedlings is to be estimated on the basis of both root and top devel-

opment, mark the red-circled samples (B-5) with a stiff wire pin at each corner, before removing the frame. After the living trees in all samples have been counted (C-3), go back and dig up each pinned sample, being careful to take only the seedlings originally within the frame. Grade the seedlings and, in the appropriate column, record the number plantable.

6. When all samples have been counted, tape and record, for the nursery unit as a whole, the total net length of seedbed actually occupied by seedlings (p. 97). In the present example, assume that the total net length of the 20 beds is 7,880 feet.

D. Calculating the Number of Living Seedlings

1. Add the numbers of living seedlings (C-3) in all samples. In the present example, assume that the total for the 160 samples is 17,536 live seedlings.

2. Compute the estimated total number of living seedlings in the unit by the formula :

$$\frac{\text{Estimated total number}}{\text{Total length of bed occupied (feet)}} = \frac{\text{Total living seedlings in samples}}{\text{Number of 1-foot-wide samples}}$$

Using the values assumed in the present example,

$$\frac{\text{Estimated total number}}{7,880} = \frac{17,536}{160}$$

$$\text{Estimated total number} = \frac{(17,536)(7,880)}{160}$$

Estimated total number = 863,648, living trees

E. Calculating the Number of Plantable Seedlings

1. If the total percentage of seedlings lost each year through fall mortality and through lifting and culling is fairly constant and is known, this figure may be subtracted from 100 and the estimated total number of living seedlings may be multiplied by the difference, with two decimal places pointed off, to get the total number of plantable seedlings.

2. If counts were made of plantable seedlings in all samples on the basis of top development alone (C-4), the estimated total number of plantable seedlings may be calculated by the formula in D-2 by substituting the plantable count for the living tree count. It may be corrected as in E-1 to allow for losses during lifting and for trees with acceptable tops but inadequate roots.

3. If the seedlings in 20 or more of the samples have been dug up and graded (C-5), multiply by 100 the number plantable in each sample, and divide the product by the total number of living seedlings (C-3) in the same sample. Next, on a sheet of cross-section paper, plot the 20 plantable percents so computed, each over its corresponding total number of live seedlings, and fit a straight

line curve to the resulting points. Third, compute for the total of all the samples counted the average number of living seedlings per frame. In the present example:

$$\frac{17,536}{160} = 109.6$$

Fourth, from the straight line curve, read the plantable percent corresponding to the average number of living trees per frame for all samples. Fifth, multiply the estimated total number of living seedlings (D-2) by the percentage read from the curve to get the estimated total number plantable. Sixth, correct the estimated total number plantable as in E-1, to allow for losses during lifting.

DIRECTIONS FOR PREPARING COMPOST FROM RICE OR OTHER STRAW "

Compost baled rice straw in a nearly square pile of convenient length and width—the larger the better—and 6 to 10 feet high ; settling during composting will considerably reduce the original height. Build the pile on level, heavy clay soil, with an open drainage ditch under the pile leading to an outside sump, from which liquid percolating through the pile can be dipped or pumped back onto the compost.

Make the outside walls of the pile of intact bales, to prevent caving, and the interior of loose straw, enriched with the following "reagent" adapted from *The Production of Artificial Farm Manures (670)* at the rate of 150 pounds per ton of air-dry organic matter, side walls included :

	Pounds per ton of air-dry Percent raw material
Ammonium sulfate	--- 45 --- 67. 5
Rock phosphate, ground to pass 200- mesh sieve	--- 23 --- 34. 5
Finely ground limestone	--- 32 --- 48. 0
Total	100 150.0

Spread the straw in the interior of the pile in layers, each only a few inches deep and each covered with a proportionate amount of the reagent. The more uniformly the straw and reagent are mixed, the more rapid and complete the decomposition of the straw and the more uniform the resulting compost.

Add water during and immediately after piling, to a total of about 500 gallons per ton of air-dry material. Thereafter, water artificially from the sump or other sources as needed to keep the pile thoroughly and continually moist until decomposition of the straw in the interior is complete. Decomposition usually requires at least

⁶⁶ Except as specifically noted, taken from *Cultural Practices in Southern Forest Nurseries (189)* and unpublished data, U. S. Forest Service.

8 to 10 months, after which the compost may be used immediately or stored in the pile 2 to 8 months longer, as best fits the nursery schedule.

Well decomposed compost from the inside of the pile should be free from large lumps of nude-composed straw, and have the consistency and odor of well-rotted horse manure. The top and sides of the pile will dry out too much to decompose well, but the sides presumably will absorb a good deal of the reagent. Undecomposed top and side material from an old pile should be mixed uniformly with fresh straw in the inside of a new pile the following year.

Rice straw may be replaced with other grain straw. Any straw may be supplemented with legume hay, grass clippings, forest litter, leaves, or other available organic materials except cone scales and seed wings—even with weeds if they have been pulled before going to seed. When wet or green material is used, its dry weight should be estimated from special records or tests, and the reagent added in the same proportion as for dry rice straw.

A 3-year average total prewar cost for such compost at one U. S. Forest Service nursery was \$3.03 per ton, wet weight, or \$9.94 per ton, oven-dry weight. Applications have usually been from one-eighth to one-fourth inch deep, broadcast, or one-fourth to one-half inch deep, on "sore spots" such as sheet-eroded areas. Based on these prices and on conversion figures from Mentz (533), 1/8-, 1/4-, 1/2-, and 1-inch applications would cost \$28.60, \$57.20, \$114.40, and \$228.80 per acre, respectively, exclusive of spreading.

There is some question about the amount of lime to include in the reagent. Presumably it improves decomposition of the straw, but on some soils 1/2- to 1-inch applications of compost containing 48 pounds of lime per ton of air-dry straw might increase the calcium content or reduce acidity undesirably. This should be investigated currently by pH determinations of the compost and of compost-treated and untreated soils, and by close watch of seedlings for early mortality or damping-off and for later chlorosis and other signs of nutritional maladjustment. The composting processes recommended by Wilde (783) omit the use of lime.

DIRECTIONS FOR HEELING-IN SEEDLINGS

1. *Select a suitable place, free from stones, gravel, and tree roots.* A level or slightly sloping, well-drained area is preferable to one poorly drained or very steep. Sandy or loamy soil is desirable because it makes digging, correct covering, and watering easier, at is not essential. Natural or artificial shelter from wind and sun is desirable, but not essential for storage up to 3 or 4 weeks. The area selected should be accessible to transportation, water, and the work. The space required varies, depending upon the size of the stock, but plenty should be allowed.

2. *Clear any grass from the heel-in bed;* extra clearing may be desirable for fire protection.

3. *Dig a trench 2 to 4 inches deeper than the seedling roots are long, and with one side smooth and slightly sloping.* For southern pine seedlings root-pruned to 8 inches, make the trench 10 to 12 inches deep. The smooth side should slope just enough so that either loose or bundled seedlings laid against it, with their roots in contact with the smooth earth all the way down, will not topple. If the ground is not level, dig the trench on the contour. An ordinary long-handled, round-pointed shovel is the best hand tool for digging the trench; the standard planting bar is inefficient. For heeling-in large quantities of stock, a plow may be adapted to make suitable trenches.

4. *Stand the seedlings in a shallow layer against the sloping side of the trench, with their root collars 1 to 2 inches below the surface of the undisturbed soil, and their roots unbent and in contact with the side of the trench throughout their length.* If the seedlings are loose, they should form a layer preferably only 2 or 3 inches, and never more than 4 inches, thick. If they have been tied in bundles of 50 or 100, the bundles need not be cut open and spread out, but should be packed closely together, in a layer only one bundle thick, along the side of the trench.

5. Depending on the quantity of stock to be heeled-in, either (a) *fill the trench carefully to a level 1 to 2 inches above the root collars of the seedlings, packing the earth against the roots at intervals during filling;* or (b) *carefully pack a 4- to 6-inch layer of earth against the roots, leaving the packed surface at the same slight slope as the original sloping wall of the trench.* Step (b) is used when one or more additional layers of seedlings are to be heeled-in; in such cases repeat steps 4 and 5 (b) as many times as needed, standing seedlings against successive 4- to 6-inch layers of packed earth, and widening the original trench as required. In any case, be careful not to bend the roots excessively, to leave roots uncovered, or to force the root collars more than 1 or 2 inches below the soil surface.

6. *Thoroughly water the soil on both sides of all rows of seedlings, washing off in the process any loose earth on the tops.*

7. *Inspect each row thoroughly to make sure all filled-in soil is firmly packed, all root collars are at least 1 inch below the level of the soil, and no tops are covered above the bottom one-fifth of their length.* Correct any mistakes found. Pay special attention to the ends of the rows, where seedlings are most likely to be insufficiently covered.

8. *Mark the ends of the row, or of the first and last rows, with stakes plainly labeled to show (a) the stock lot, and (b) the date of heeling-in.* Without such labels the identity of the stock may be permanently lost, and the stock itself may die from overlong storage.

9. *Water the stock in the heel-in bed often enough to keep the soil continually moist.*

DIRECTIONS FOR BALING SEEDLINGS

A. Equipment

1. Tank or trough for soaking sphagnum moss.
2. Fork for handling wet moss.
3. Wooden or reinforced hardware-cloth screen for draining excess water from moss. (A clothes wringer may be used instead.)
4. For each baler, a table at least 4 feet long by 21/2 feet wide, of convenient height, with 10- or 12-inch side supports (fig. 29, p. 101).
5. For each baler, a strapping machine or wire-tying machine ; 3/8-inch strap or No. 12 wire is commonly used. Despite the cost, it is cheaper to have one or two extra machines on hand than to incur a breakdown in packing through the failure of one.

B. Material Per Bale

1. Two wooden slats 1 by 2 by 24 inches. (For very tall seedlings, 30-inch slats.)
2. One waterproof wrapper 6 by 2 feet (for very tall seedlings, 6 by 3 feet), of 7-ounce burlap backed with asphalt and kraft paper, or of heavy waterproof crepe paper reinforced with sisal fibers. The essentials are (a) sufficient toughness to stand packing and shipping; and (b) resistance to water sufficient to keep bale from drying out and, if bales are shipped by express, to meet common-carrier's requirements about avoiding injury to other merchandise. For latest specifications, sources, and prices, write Regional Forester, U. S. Forest Service, Atlanta, Ga.
3. Supply of sphagnum moss. (Leftover moss may be stored dry in the bales in which purchased, or, after drying in shallow layers, in indoor bins or piles, until the following year.)
4. Two 3/8-inch by approximately 5-foot metal straps, or equivalent wires, to fit make of strapping machine or wire-tying machine used.
5. Two fastening seals.

C. Baling

1. Lay two straps across the table, about 18 inches apart. (The distance apart depends on the size of the seedlings and the way they go together in the bale, as explained in 5 and 10, following.)
2. Lay one slat at right angles across the straps.
3. Lay a wrapper, with its long dimension across the table (fig. 29, A, p. 101), on top of the straps and slat.
4. Across almost the full width of the wrapper spread a layer of drained or wrung-out sphagnum moss 18 to 24 inches wide from front to back, and thick enough (21/2 to 3 inches) to protect the seedlings.
5. On the layer of moss place loose or bundled seedlings with the sparser lower parts of their root systems overlapping over the center-line of the

wrapper and their root collars well inside the edges of the wrapper, but at least the tips of their needles projecting well beyond the wrapper (fig. 29, B). The seedling tops, however, should not project so far beyond the wrapper as to flop loose or to be injured in handling the bale. The layer of seedlings should not be more than 3 to 4 inches thick. The exact position of the seedlings depends mainly on their size. On each side of the layer the root collars should be about equally distant from the edge of the wrapper.

6. Spread 2 to 3 inches of moss over the roots and far enough up the stems to cover the root collars and to maintain the thickness of the bale to a point slightly outside the strap on either side. The moss must extend beyond the seedlings, both front and back, to meet the first layer of moss.

7. Repeat steps 5 and 6 until the bale is the desired size, ending with a top layer of moss 21/2 to 3 inches thick (fig. 29, A). (Numerous thin layers of seedlings and moss require little more labor than fewer, thicker layers, and make a better bale, especially for long shipment or several clays' storage.) The U. S. Forest Service generally makes up bales to weigh about 60 pounds apiece, before supplementary watering, letting the number of seedlings per bale vary according to the size of the stock. With a little practice, checked by weighing of bales, most bales can be made remarkably uniform.

8. Making sure that there is everywhere at least a 2 1/2- to 3-inch layer of moss between the wrapper and the nearest seedling roots, bring the two ends of the wrapper neatly together in a double layer above the top of the bale.

9. Take the second slat and roll both ends of the wrapper jointly around it until the wrapper has pulled the bale together as tightly as can be managed conveniently by hand (fig. 29, B).

10. Bring the straps around the bale; tighten each firmly but not crushingly with the strapping machine (fig. 29, B) ; seal and cut off. The straps must go around the bale fairly near the edges of the wrapper and somewhat above the root collars of the seedlings (less far, but still definitely above, in the case of longleaf pine) in such a way that rough handling cannot cause the seedlings or straps to loosen or shift, or seedlings or moss to fall out.

11. The finished bales are kept on their sides but may be stood on end, temporarily, for watering and draining before or during shipment or storage.

DIRECTIONS FOR CORRECT PLANTING WITH HAND TOOLS

Although breaking them down into numbered steps makes the following directions lengthy, it permits teaching planters to perform each step correctly, with minimum expenditure of time and energy, and to *save waste motions*. For example, the 14 steps in the first method described, once

mastered, flow smoothly into each other and are performed in from 20 to as few as 10 seconds.

At the completion of planting by any of the methods, the root collar of the seedlings should be at the surface of the soil unless for special reasons it has been ordered set slightly below. A change from greenish to yellowish bark marks the root collar of most seedlings.

The directions are for right-handed planters. For left-handed planters, right and left should be reversed.

Bar Planting With Standard Bar and Ehrhart Tray, Each Man Carrying and Setting His Own Trees

1. Hold tray in left hand (sloping end, with seedling tops, to rear) and bar in right hand (with step turned to right); select planting spot.

2. Set tray down to left of and slightly beyond planting spot, out of way but within easy reach (fig. 37, *B*, p. 134).

3. With one or two strokes of right heel or of bar blade, clear 4- by 6-inch strip of all grass and trash. (Heel preferred if planters' shoes are good. Bar must be used if shoes are poor; it takes about 10 percent longer. Not more than a couple of seconds should be spent clearing the spot.)

4. Using both hands, and with bar inclined slightly toward body so that far side of *blade* is *vertical*, sink blade full length into soil to make planting slit at least 4 inches beyond the near end of cleared strip (fig. 60, *A*). Use right foot on step if hardness of ground requires it.

5. Pull handle of bar about 4 inches toward body to open top of planting slit a maximum of about 1 1/2 inches and to loosen blade in soil (fig. 60, *B*). *Do not push bar from body*; to do so will disturb face of planting slit (fig. 60, *A* and *F*), which should remain vertical and intact to keep seedling upright and (theoretically at least) to insure maximum movement of water through soil to roots.

6. Withdraw bar from slit.

7. Set edge of blade 2 inches behind rear edge of planting slit (fig. 60, *C*), supporting bar by shaft with right hand.

8. Drop to right knee (or bend over or squat); with left hand take one seedling from tray and insert roots in planting slit so that they are not doubled up and so that root collar is 1 to 1 1/2 inches below surface of soil (fig. 60, *C*).

9. Shake seedling and raise root collar to soil surface to insure straightness of all roots (fig. 60, *D*).

10. Holding seedling upright and at correct depth with left hand, thrust bar blade about 2 inches into soil with right hand and swing handle forward (fig. 60, *E*) so that earth forced into top of planting slit holds seedling in position.

11. Release seedling from left hand; rise to feet, set bar 3 1/2 to 4 inches back of seedling stem, and drive blade full length into soil to make closing slit. Bar should be at angle indicated in position 1 in figure 60, *F*, so that cutting edge will miss roots at bottom of planting slit by about 2 1/2 inches.

12. Pull bar handle about 6 inches toward body, to position 2 of figure 60, *F*, to close bottom of planting slit; then thrust it forward 12 or 14 inches to position 3 to close top of slit, but not far enough to hump up earth excessively or to move seedling from vertical.

13. Withdraw bar from closing slit, take in right hand, pick up tray with left hand, set right heel across closing slit, and in stepping forward mash earth into closing slit and firm it against seedling on same level as surrounding ground.

14. Pace distance to next planting spot.

Bar Planting With Standard Bar, Men Working in Pairs

Exactly as in preceding, except that steps 7 and 10 are omitted, and second man handles tray or other container in steps 1, 13, and 14 and performs steps 8 and 9, holding seedling in place till the barman has completed step 12. A right-handed tray man usually works on the barman's right, a left-handed tray man on his left.

Mattock (Grub Hoe) Center Hole Planting

1. Approach planting spot with tray in left hand, grub hoe in right.

2. Set tray down to left of and slightly beyond spot.

3. With grub-hoe blade, clear all grass and trash from 12- by 12-inch square.

4. With fewest possible strokes, dig hole slightly wider and deeper than root system; pile earth from hole compactly to right of hole and break up any large, hard lumps with blade.

5. Lay grub hoe down to right of pile.

6. Drop to right knee (or bend over or squat), and with left hand take one seedling from tray.

7. Gaging depth by eye, and using right hand, fill bottom of hole with loose earth to point slightly above maximum depth of root system.

8. With seedling in left hand, spread lowest root tips out on loose earth in hole.

9. Fill hole half full of loose earth with right hand, spreading and sifting earth under and among lower roots and firming it with right fist.

10. Holding seedling vertical with left hand, similarly fill rest of hole to slightly above surrounding ground level; this should bring loose earth just above root collar of seedling.

11. Pick up tray in left hand and grub hoe in right, rise to feet, place balls of feet on loose earth on either side of seedling, and jounce once to pack level with root collar.

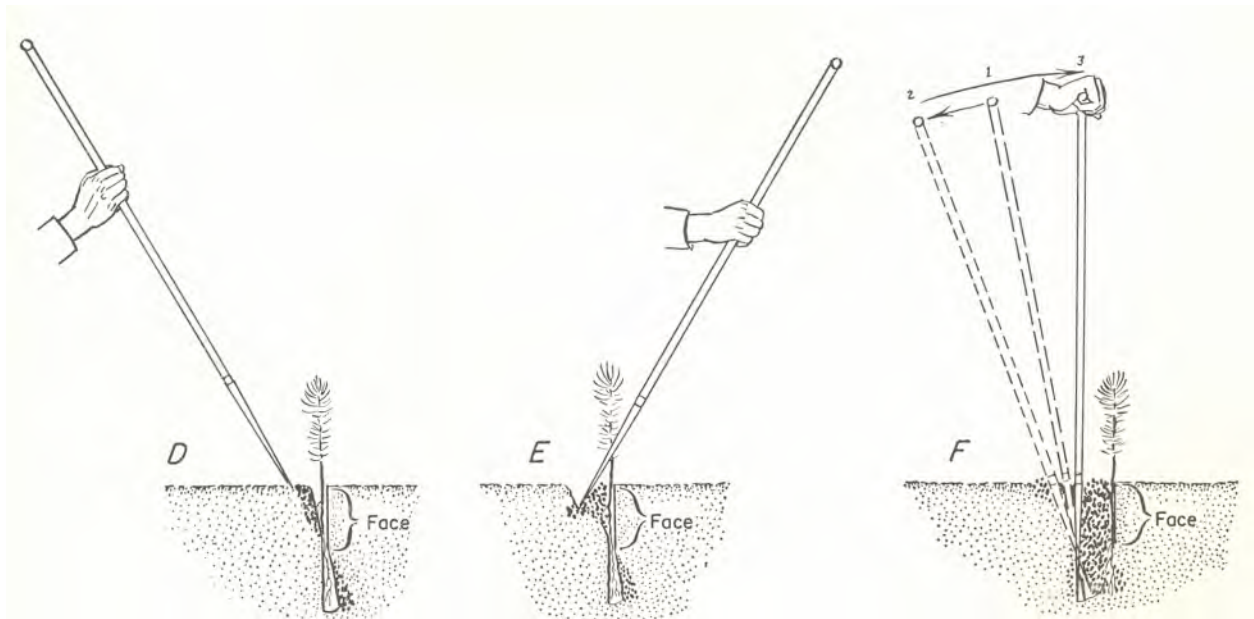
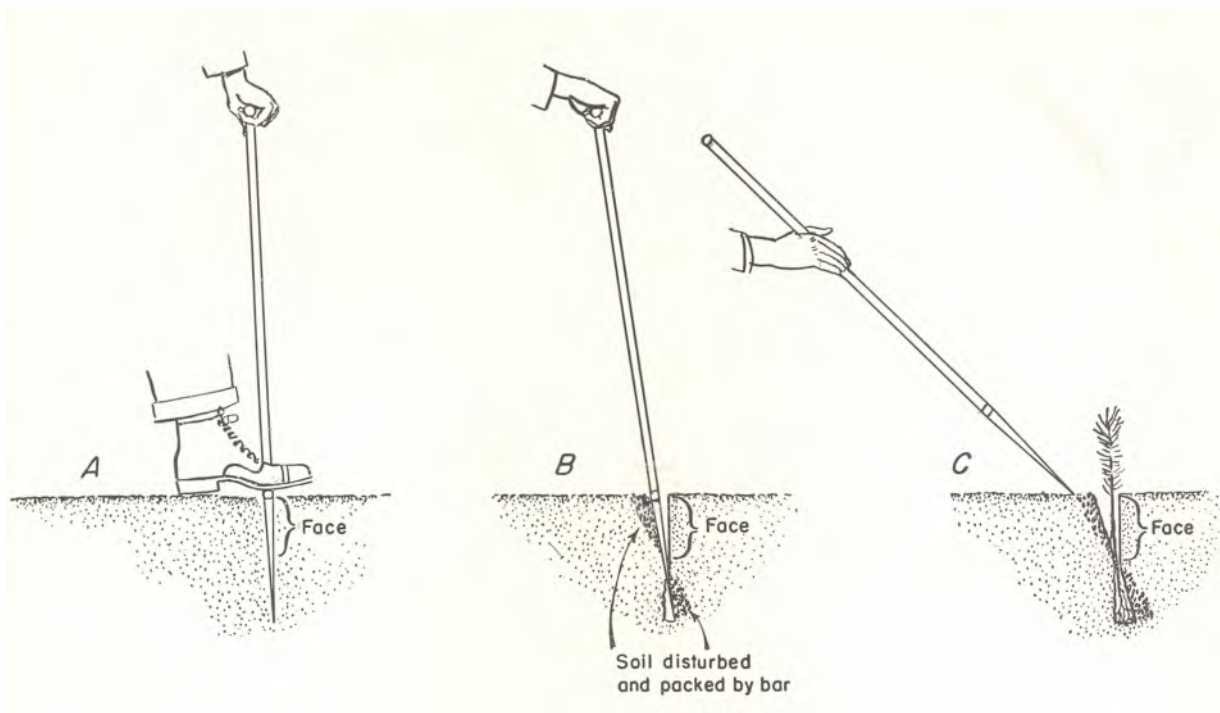

FIGURE 60.—Bar planting, with each man carrying and setting his own trees. *A*, Starting the planting slit ; face is vertical. *B*, Enlarging the planting slit and loosening bar. *C*, Inserting seedling in slit till root collar is below surface of soil. *D*, Raising root collar to soil surface. *E*, Closing top of planting slit to hold seedling temporarily in place. *F*, Making closing slit and packing soil firmly against roots, without disturbing face.

12. Pace distance to next spot.

In center-hole planting the roots are spread fairly naturally in all directions and are surrounded entirely by loosened soil (fig. 61). The method is especially applicable on stony sites, hard soils, and with large-rooted planting stock, but is slow.

Planting the Southern Pines

Mattock (Grub Hoe) Side-Hole Planting

1, 2, and 3. As in center-hole planting.

4. Sink grub-hoe blade vertically into soil, full length, beyond middle of cleared square, and drag toward body and upward to make hole with smooth, vertical face (fig. 62) on far side. (In

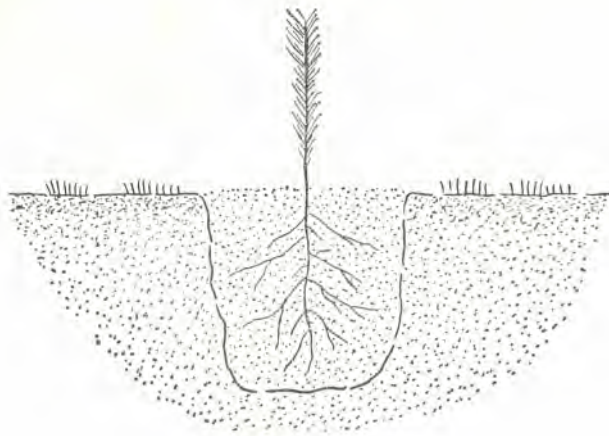

FIGURE 61.—Center-hole planting with mattock or grub hoe. The roots are well spread, and surrounded by loosened and repacked soil.

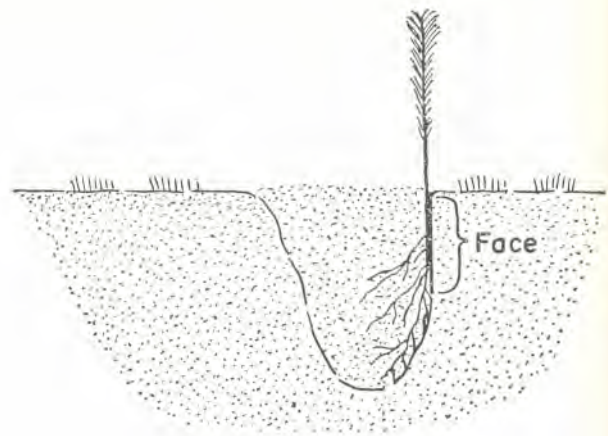

FIGURE 62.—Side-hole planting with mattock or grub hoe. The roots are partly spread out in loosened and repacked soil, partly in contact with vertical face of undisturbed soil.

hard soil two or more strokes will be needed.) Pile earth compactly to right of hole, crumbling with blade if in hard lumps.

5. Lay grub hoe down to right of pile.

6. Drop to right knee; with left hand take one seedling from tray and place its roots against vertical far wall of hole, with root collar exactly at surface of ground.

7. Holding seedling upright in position with left hand, fill hole half full of loose earth with right hand, working earth among roots toward center of hole, and packing with right fist.

8. Still holding seedling upright with left hand, fill rest of hole with right hand, to slightly above level of root collar and surrounding ground.

9. Pick up tray with left hand and grub hoe with right. Rise to feet, and step on loose earth with ball of right foot to pack it level with surrounding surface.

10. Pace distance to next spot.

The side-hole method is somewhat quicker than the center-hole, and has the added possible advantage that part of the roots are in contact with soil of undisturbed structure.

Mattock (Grub Hoe) Slit Planting With Narrow-Bladed Tool in Light Soil

1, 2, and 3. As in center-hole planting.

4. Sink blade full length into soil near center of cleared square, as nearly vertical as possible (position 1, fig. 63, *A*).

5. Raise handle slightly to position 2 of same figure, then drag strongly backward and downward to position 3, leaving about 1 inch between far side of blade and far side of slit.

6. With right hand still pulling strongly on handle, near blade, drop to right knee.

7. With left hand take one seedling from tray; insert roots, without doubling them up, between blade and far side of slit, till root collar is 1 to 1 1/2 inches below soil surface.

8. With left hand shake seedling to straighten root tips, and raise root collar to soil surface (fig. 63, *B*).

9. Holding seedling vertical and at correct depth with left hand, withdraw grub hoe from slit with right hand, and by a poke with the blade

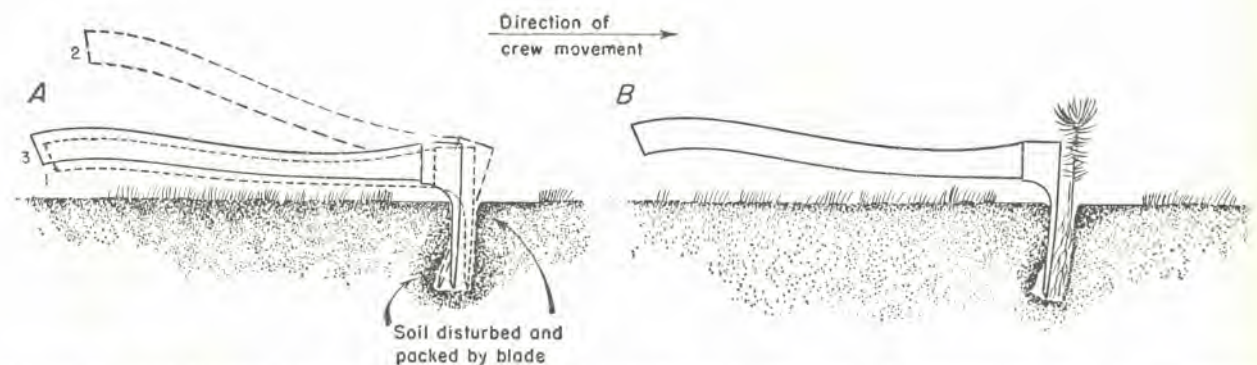

FIGURE 63.—Slit planting with narrow-bladed mattock or grub hoe in light soil. *A*, Opening the slit. *B*, Seedling in final position before blade is withdrawn.

close the top of the slit enough to hold the seedling temporarily in correct position.

10. Keep grub hoe in right hand, pick up tray in left hand, rise to feet, and close slit completely and level with surrounding surface with one or two downward and forward thrusts of right heel.

11. Pace distance to next spot.

Mattock (Grub Hoe) Slit Planting With Broad-Bladed Tool in Heavy Soil

1, 2, and 3. As in center-hole planting.

4. Drive blade full length into soil at far side of spot, at angle which will bring cutting edge 8 inches below surface (position 1, fig. 64, *A*).

5. Turn handle of grub hoe upright to position 2 of same figure, until 1-inch-wide gap appears between edge of hole in ground and edge of blade with its clod of earth. (In some soils the blade does not have to be turned entirely out of ground to open wide enough gap.)

6. Holding handle in position 2 with right hand, drop to right knee, take one seedling from tray with left hand, and insert in gap, with roots as straight as possible and root collar 1 to 1½ inches below soil surface.

7. Shake seedling with left hand and raise root collar to soil surface (fig. 64, *B*).

8. Holding seedling upright and at correct depth with left hand, rock grub hoe back with right hand to position 1 of figure 64, *A*, replacing clod of earth in hole to cover roots.

9. Release seedling with left hand, withdraw grub hoe from soil with right hand, pick up container with left hand, rise to feet, and set right heel firmly on loosened clod of earth to pack and level it.

10. Pace distance to next spot.

DIRECTIONS FOR CONTROL OF POCKET GOPHERS

Initial control of pocket gophers (p. 153) by either traps or poison may be before, during, or even considerably after planting, depending upon when burrowing or injury first becomes noticeable. Retreatment at 1- or 2-year intervals frequently is necessary.

Effective, economical control depends upon (1) general preliminary information concerning the location, extent, and seriousness of gopher infestations; (2) thorough coverage, by the control crew, of each area treated; and, (3) intimate knowledge, on the part of each member of the control crew, of the burrowing habits of the gophers. In any one locality, gopher burrows usually follow a distinct pattern. Learning this pattern, by a little systematic digging, probing, and observation, greatly reduces the time required to place either traps or baits effectively.

The U. S. Forest Service has obtained good coverage of treated areas by two methods. One is to have a special crew gridiron the area at 10- to 25-foot intervals, either before or after planting, and treat all active gopher colonies found. The other is to have in each planting crew a few men trained and equipped for gopher control, and to have them treat all colonies discovered during planting.

Scouting for and treatment of pocket gophers, and checking on the success of treatments, must be done mostly during the season of active burrowing, usually from November to the middle of May.

⁶⁶ Based on material in three articles (150, 201, 466) and unpublished data, U. S. Forest Service.

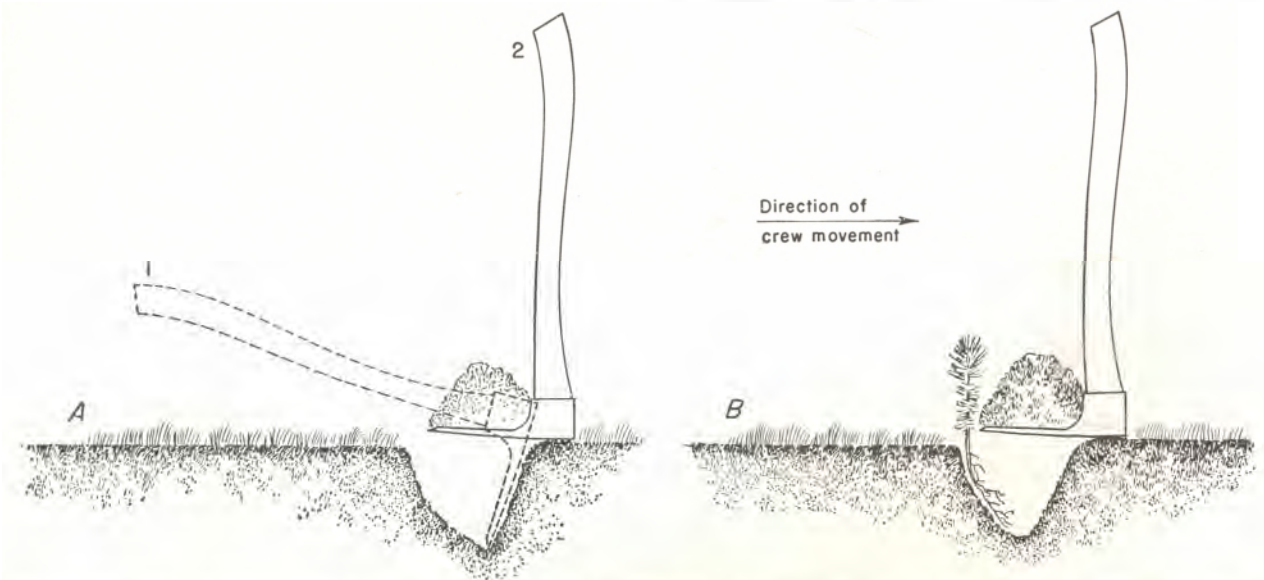

FIGURE 64.—Slit planting with mattock or grub hoe in heavier soil. *A*, Opening slit. *B*, Seedling in final position before closing slit.

Trapping

Satisfactory traps, which require no bait, are advertised in nursery journals and agricultural supply catalogues. Current recommendations may be obtained from the Fish and Wildlife Service, U. S. Department of the Interior, Washington, D. C.

To set traps, locate a lateral or main burrow 12 to 18 inches from an obviously fresh mound, by probing with a ½-inch iron rod, and cut into it with a shovel. Clear the loosened earth from the burrow with a spoon, disturbing the burrow walls as little as possible. Set *two* traps as far within the burrow as convenient, one on each side of the hole to insure the gopher's running into a trap either way he comes. Set the treadles lightly and fasten each trap, by a soft, flexible wire, to a stake at one side. Fill the hole, but not quite completely; leakage of a little light seems to tempt the gopher to repairs. Revisit the traps as frequently as conditions warrant, emptying them and resetting them near the freshest neighboring mounds. If many gophers are present traps will usually be sprung within 24 hours; in active, previously untrapped colonies they may be sprung within 20 minutes.

Poisoning

Poisons may be applied in any one of several baits (p. 213). If fresh mounds in the treated area a few days after baiting show that one bait has failed, try another.

Go back and forth over the infested area at 10- to 25-foot intervals, probing for burrows. Wooden, iron, or iron-shod probes about the diameter of a broom handle, sometimes equipped with footrests, are used. Burrows will be found mostly near or between fresh mounds. Probing is easiest when the soil is moderately moist.

Wherever the probe enters a burrow, drop in one or two pieces of poisoned carrot or sweet potato, or 1 tablespoonful of poisoned wheat, rolled oats, or milo maize. Be careful to thrust the probe only *into* the burrow, not through into its bottom, lest the bait go too deep and be overlooked. The probe hole need not be closed.

Evidence of successful poisoning is lack of fresh mounds on the area a few days or weeks after treatment. This lack is most easily checked after a hard rain.

DIRECTIONS FOR CONTROL OF TEXAS LEAF-CUTTING ANTS ⁵⁷

On sizable areas in Louisiana and Texas, the U. S. Forest Service has controlled Texas leaf-cutting ants effectively with methyl bromide (p.

⁵⁷ Based on material in two articles (358, 549), unpublished reports by Peter J. Coronello, formerly of the Koa-bite National Forest, and unpublished data.

206) by combining methods developed for this chemical by the U. S. Bureau of Entomology and Plant Quarantine with techniques previously developed by the Forest Service for applying carbon disulfide (p. 205). Costs, before World War II, averaged about \$3.00 per acre of colony treated, and about \$0.02 per acre of plantation protected.

The success attained has depended on : (1) Utilizing all the evidence described on page 154 to find and identify any colonies; (2) confining treatment to the period between the first hard frosts and some time in March ; (3) treating (with carbon disulfide especially) only when the temperature was above freezing but still low enough that the ants remained in the nest ; (4) treating in advance of planting; (5) treating *immediately*, regardless of weather, when active colonies were discovered on areas being planted; and (6) re-treating during the same or following seasons whenever earlier treatment failed to eradicate the colony. No chemical tested has been appreciably successful in hot weather. Methyl bromide or carbon disulfide is largely wasted if applied late in the morning or during the afternoon of warm, bright days in winter, when most of the ants are out of the nest. Planting within foraging distance of a nest should be stopped until treatment has been applied. Unless these precautions are taken, ants may attack and defoliate seedlings within 10 minutes of planting.

Treatment With Methyl Bromide

Methyl bromide has many advantages over carbon disulfide in killing town ants (357). It is nonflammable and nonexplosive. It requires no special containers, as it can be bought in 1-pound sealed cans for which band applicators are obtainable. The rubber tubes required for use can be attached directly to these applicators. Only 1 pound of chemical is needed for colonies under an acre in size, and 1 pound per acre for larger colonies. Methyl bromide is applied only to the central parts of small colonies, and only in about four holes per acre in large ones. Neither treated nor untreated holes need be closed. Because of these advantages, one-man crews can, if desired, treat all colonies of ordinary size.

Methyl bromide, despite its nonflammability, must be handled with caution. Sealed in 1-pound containers it is largely liquid, but develops high pressures ; extreme care must therefore be used in opening the can with the band applicator, lest the chemical be sprayed on the body. At ordinary pressures and temperatures, it is a gas. Excessive inhaling of the gas results in dizziness, vomiting, and double vision. In extreme cases it may be fatal. Continued exposure to the liquid or gas may result in burning. Oil-dressed leather shoes or gloves may absorb enough methyl bromide to cause severe injury. With care, however, the chemical may be used outdoors without a mask.

Containers should never be opened indoors without a gas mask.

With the above exceptions, directions for controlling Texas leaf-cutting ants with methyl bromide are identical with those which follow for carbon disulfide.

Treatment With Carbon Disulfide

The advantage of carbon disulfide is its general availability. Its disadvantages are : High flammability and explosiveness, making extreme caution necessary in transportation and use; the thoroughness of dosage required, making 2- to 3-man crews preferable for treating all but the smallest colonies ; and the necessity for closing all discoverable burrows when applying the chemical. Properly applied, however, carbon disulfide works.

The equipment per man required for applying carbon disulfide consists of :

One covered gallon container, with spout for accurate pouring.

One 5-foot length of 1/4-inch hard rubber tubing, cut squarely at one end and at 45° at the other.

One small funnel, inserted in the square-cut end of the tube, and marked to measure exactly 1.6 fluid ounces when the tube is pinched just below it.

One laboratory spring clamp to close the tube below the funnel while measuring.

In addition, the U. S. Forest Service has found it expedient to provide a tall, white-painted durable post, serially numbered, with which to mark each colony treated (with conspicuous red flags for obscurely located colonies), and forms to re-

cord the serial number, size, and date or dates of treatment of each colony, the number of ant holes treated, the total amount of carbon disulfide used, and the total man-hours and truck miles required. The locations of all treated colonies are plotted on (usually 2-inch-to-the-mile) plantation maps. Only by means of such information can colonies be reexamined and re-treated as necessary, treatments evaluated, and costs compared.

In applying carbon disulfide, crew members cross and recross the colony abreast, 10 feet apart, each man injecting the chemical in *one* nest opening in each 100 square feet, and closing with his heel *all* treated and untreated holes found in his 10-foot strip. In treating, the diagonally cut end of the tube is eased into a hole, with a twisting motion, as far as it will go, preferably 2 feet.

(The tube prevents absorption of carbon disulfide by surface soil.) Then the tube is clamped, 1.6 fluid ounces of carbon disulfide poured into the funnel, the clamp is released, and the chemical allowed to drain into the nest. The chemical is *not* exploded after injection ; the risk of injuring crew members and starting fires is too great, and U. S. Forest Service tests have shown that the chemical is more effective unexploded. Nevertheless, "firing" an occasional colony, by cautiously dropping a lighted match into a treated hole, is instructive because of the numerous overlooked holes, some at great distances, which the puffs of dust from the explosion reveal.

Carbon disulfide treatments cannot be made in cold weather because the chemical freezes around the nozzle of the can at temperatures somewhat above the freezing point of water.